



















CHIRURGIE
SURGERY
CHIRURGIE
CIRUGIA
ХИРУРГИЯ



| | | | | | |
|-----------|--|---|-----------|---|---|
| 1 | <ul style="list-style-type: none"> • Skalpelle • Scalpels • Bistouris • Bisturíes • Скальпели |  | 13 | <ul style="list-style-type: none"> • Wundhaken • Retractors • Ecarteurs • Separadores • Ранорасширители |  |
| 3 | <ul style="list-style-type: none"> • Scheren • Scissors • Ciseaux • Tijeras • Ножницы |  | 15 | <ul style="list-style-type: none"> • Wundspreizer • Self-Retaining Retractors • Ecarteurs autostatiques • Separadores con retenida automática • Самоудерживающиеся ранорасширители |  |
| 5 | <ul style="list-style-type: none"> • Pinzetten • Forceps • Pincés • Pinzas • Пинцеты |  | 17 | <ul style="list-style-type: none"> • Sonden, Trokare, Hähne • Probes, Trocars, Stopcocks • Sondes, Trocarts, Robinets • Sondas, Trócares, Llaves • Зонды, троакары, краны |  |
| 7 | <ul style="list-style-type: none"> • Tupfer- und Kornzangen • CottonSwap Forceps • Pincés a tampones et pansements • Pinzas para tapones y curaciones • Зажимы для тампонов и корнцанги |  | 19 | <ul style="list-style-type: none"> • Galle, Leber, Niere, Blase, .Urologie • Gall, Liver, Kidney, Bladder, Urology • Vésicule biliaire, Foie, Rion, .Urologie • Bulle, Bilis, Hígado, Riñon, Urología • Желчный пузырь, печень, почки, мочевого пузырь, урология |  |
| 9 | <ul style="list-style-type: none"> • Klemmen • Forceps • Pincés • Pinas • Зажимы, щипцы |  | 21 | <ul style="list-style-type: none"> • Magen, Darm, Mastdarm • Stomach, Intestines, Rectum • Estomac, Intestin, Rectum • Estómago, Intestino, Recto • Желудок, кишечник, прямая кишка |  |
| 11 | <ul style="list-style-type: none"> • Nahtinstrumente • Suture Instruments • Instruments a sutura • Instrumentos para sutura • Шовный инструмент |  | 23 | <ul style="list-style-type: none"> • Gynäkologie, Geburtshilfe • Gynaecology, Obstetrics • Gynécologie, Obstétrique • Ginecología, Obstetricia • Гинекология, акушерство |  |

| | | |
|----|--|---|
| 25 | <ul style="list-style-type: none"> • Vorbereitung, Dermatologie • Preparation, Dermatology • Préparation, Dermatologie • Preparación, Dermatología • Препарирование, дерматология |  |
| 27 | <ul style="list-style-type: none"> • Knochenchirurgie • Bone Surgery • Chirurgia ossea • Cirugía ósea • Костная хирургия |  |
| 29 | <ul style="list-style-type: none"> • Sterilisation • Sterilization • Stérilisation • Esterilización • Щипцы стерилизационные |  |
| 31 | <ul style="list-style-type: none"> • Tonometer • Tonometer • Le Tonometre • El Tonometro • Тонометр |  |
| 33 | <ul style="list-style-type: none"> • Stimmgabeln für Ohrenärzte • Tuning Forks for Aurists • Diapasons pour auristes • Diapasones para otologos • Камертон для ЛОР врачей |  |
| 35 | <ul style="list-style-type: none"> • Inhaltsverzeichnis - I • Index - II • Index - III • Indice - IV • Содержание - V |  |

**Skalpellklingen, Skalpellgriffe, Messer
Scalpel Blades, Scalpel Handles, Knives
Lames de bistouris, Manches de bistouris, Couteaux
Hojas de bisturías, Mangos de bisturías, Cuchillos
Лезвия для скальпеля, ручки скальпеля
к съёмным лезвиям, ножи**





No. 3
13,0 cm, 5"
01-10-003-00

No. 3
13,0 cm, 5"
01-10-003-01

No. 3L
21,0 cm, 8¹/₄"
01-10-003-02

No. 7
16,5 cm, 6¹/₂"
01-10-007-00

No. 7K
13,0 cm, 5"
01-10-007-01

No. 7L
22,0 cm, 8³/₄"
01-10-007-02

No. 3
21,0 cm, 8¹/₄"
01-10-006-00



Einmal-Skalpelle, steril
 Disposable Scalpels, sterile
 Bistouris usage unique, stériles
 Bisturios para uso único, estériles
 Одноразовые скальпели

1



Fig. 10
01-10-050-10



Fig. 11
01-10-050-11



Fig. 12
01-10-050-12



Fig. 12d
01-10-050-12D

In Packungen zu 10 Stück, einzeln steril verpackt
 In packages of 10 ea., individually packed sterile
 Stérile enveloppe individuelle boîte de 10 bistouris
 En boîtes de 10 pièces, en sachets individuels, stériles
 В пачке 10 шт., каждый запечатан отдельно, стерильные



Fig. 13
01-10-050-13



Fig. 15
01-10-050-15



Fig. 15c
01-10-050-15C



Fig. 18
01-10-050-18



Fig. 19
01-10-050-19



Fig. 20
01-10-050-20



Fig. 21
01-10-050-21

In Packungen zu 10 Stück, einzeln steril verpackt
 In packages of 10 ea., individually packed sterile
 Stérile enveloppe individuelle boîte de 10 bistouris
 En boîtes de 10 pièces, en sachets individuels, stériles
 В пачке 10 шт., каждый запакован отдельно, стерильные



Fig. 22
01-10-050-22



Fig. 23
01-10-050-23



Fig. 24
01-10-050-24



Fig. 25
01-10-050-25

Skalpellklingen, steril, auswechselbar
Scalpel Blades, Sterile, Interchangeable
Lames de bistouris, stériles, interchangeables
Hojas de bisturios, esteriles, intercambiables
Лезвия для скальпеля, сменные

1



Fig. 10 01-10-020-10 Fig. 11 01-10-020-11 Fig. 12 01-10-020-12 Fig. 12d 01-10-020-12d Fig. 13 01-10-020-13 Fig. 14 01-10-020-14 Fig. 15 01-10-020-15 Fig. 15c 01-10-020-15c

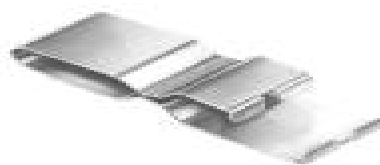

Fig. 16 01-10-020-16 Fig. 17 01-10-020-17 Fig. 18 01-10-020-18 Fig. 19 01-10-020-19 Fig. 20 01-10-020-20 Fig. 21 01-10-020-21 Fig. 22 01-10-020-22 Fig. 23 01-10-020-23

In Packungen zu 100 Stück, einzeln steril verpackt
 In packages of 100 ea., individually packed sterile
 Enveloppe individuelle boîte de 100 lames
 En boites de 100 pieces, en sachets individuels, steriles
 В пачке 100 шт., каждый запечатан отдельно, стерильные



Fig. 24 01-10-020-24 Fig. 25 01-10-020-25 Fig. 36 01-10-020-36



Kling-Ex
Skalpellklingenabnehmer
 01-10-020-40



Skalpellklingenabnehmer
 14 cm
 01-10-020-14



OPERATION
 17,0 cm, 6¾"

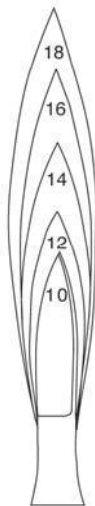

Fig. 10 **01-10-060-10**
 Fig. 12 **01-10-060-12**
 Fig. 14 **01-10-060-14**
 Fig. 16 **01-10-060-16**
 Fig. 18 **01-10-060-18**



COLLIN
 16,0 cm, 6¼"



Fig. 1 **01-10-066-01**
 Fig. 2 **01-10-066-02**
 Fig. 3 **01-10-066-03**



Fig. 4 **01-10-066-04**
 Fig. 5 **01-10-066-05**
 Fig. 6 **01-10-066-06**



Fig. 1 **01-10-070-01**
Fig. 2 **01-10-070-02**
Fig. 3 **01-10-070-03**
Fig. 4 **01-10-070-04**
Fig. 5 **01-10-070-05**



Fig. 1 **01-10-076-01**
Fig. 2 **01-10-076-02**
Fig. 3 **01-10-076-03**
Fig. 4 **01-10-076-04**
Fig. 5 **01-10-076-05**



Fig. 15
01-10-078-15



DISSECTING
17,0 cm, 3/4"

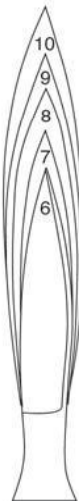

Fig. 6 **110-070-06**
Fig. 7 **110-070-07**
Fig. 8 **110-070-08**
Fig. 9 **110-070-09**
Fig. 10 **110-070-10**



DIEFENBACH
16,0 cm, 6 1/4"



Fig. 6 **01-10-076-06**
Fig. 7 **01-10-076-07**
Fig. 8 **01-10-076-08**
Fig. 9 **01-10-076-09**

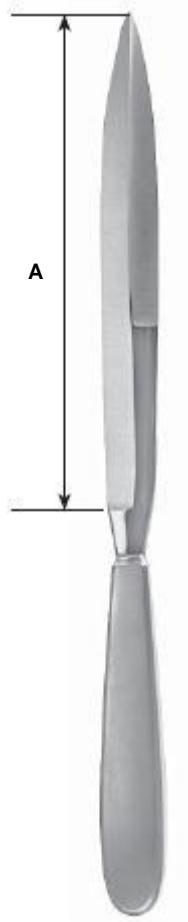

Fig. 16
01-10-078-16



COLLIN

A
 13,0 cm, 5" **01-10-080-13**
 16,0 cm, 6¼" **01-10-080-16**
 19,0 cm, 7½" **01-10-080-19**
 22,0 cm, 8⅝" **01-10-080-22**
 28,0 cm, 11" **01-10-080-28**



CATLIN

A
 16,0 cm, 6¼" **01-10-082-16**
 19,0 cm, 7½" **01-10-082-19**
 22,0 cm, 8⅝" **01-10-082-22**



LISTON

A
 17,0 cm, 6¾" **01-10-250-17**
 20,0 cm, 8" **01-10-250-20**



Amputationsmesser, Messer für Autopsie
Amputation Knives, Post Mortem Knives
Amputation de couteaux, Couteau pour autopsie
Cuchillos para amputación, Cuchillos para autopsia
Ножи ампутационные, ножи для органов

1



LANGENBECK

A
16,0 cm, 6½" 01-10-280-16



WALB

A
11,0 cm, 4½" 01-10-150-11
14,0 cm, 5½" 01-10-150-14
17,0 cm, 6¾" 01-10-150-17

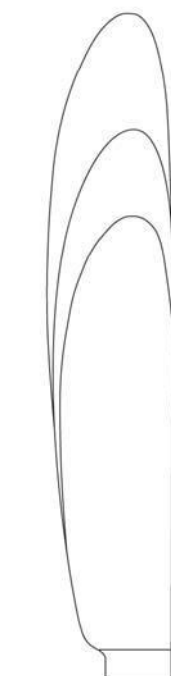

VIRCHOW

A
16,0 cm, 6¼" 01-10-180-16
20,0 cm, 8" 01-10-180-20
24,0 cm, 9½" 01-10-180-24

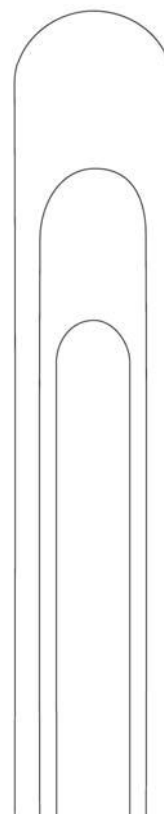



LANGENBECK
18,0 cm, 7"
01-10-105-55



CARTILAGE
17,5 cm, 6 $\frac{5}{8}$ "
01-10-110-65

mit Schaber
with raspatory
manche solide a rugine
con periostótomo
с распатором

Haut-Spannplatten
Skin straightening plate
Plaque pour tendre la peau
Placa para extender la piel
Пластина для натяжения



01-10-422-30

01-10-401-19
Ersatzklinge
Spare blade
Llame de rechange seule
Hoja de repuesto
Запасное лезвие



SILVER
19 cm, 7½"
01-10-400-19

01-10-411-30
Ersatzklinge
Spare blade
Lame de rechange seule
Hoja de repuesto
Запасное лезвие



BRAITHWAITE
30 cm, 12"
01-10-410-30

01-10-413-35
Ersatzklinge
Spare blade
Lame de rechange seule
Hoja de repuesto
Запасное лезвие



HUMBY
35 cm, 14"
01-10-412-35

01-10-421-30
Ersatzklinge
Spare blade
Lame de rechange seule
Hoja de repuesto
Запасное лезвие



SCHINK
30 cm, 12"
01-10-420-30



SIMON
 23,5 cm, 9 1/2"



Fig. 1
 01-10-01-10-01



1/1
 Fig. 2
 01-10-01-10-02



Fig. 3
 01-10-01-10-03



1/1
 Fig. 4
 01-10-01-10-04



Fig. 3



BARRON
 13,0 cm, 5 1/2"
 01-10-014-14



DIEFFENBACH
 13,0 cm, 5"
 01-10-100-13



DIEFFENBACH
 13,0 cm, 5"
 01-10-101-13

Skalpelleklingen, auswechselbar
 Scalpel Blades, Interchangeable
 Lames de bistouris, interchangeables
 Hojas de bisturíes, intercambiables
 Лезвия для скальпеля, сменные

1



Fig. 61
01-10-040-61



Fig. 62
01-10-040-62



Fig. 62S
01-10-040-62S



Fig. 64
01-10-040-64



Fig. 65
01-10-040-65



Fig. 67
01-10-040-67



Fig. 69
01-10-040-69



10,0 cm
01-10-030-10



13,00 cm
01-10-030-13



15,00 cm
01-10-030

Scheren
Scissors
Ciseaux
Tijeras
Ножницы





10,5 cm, 4¼" **03-11-000-10**
 11,5 cm, 4½" **03-11-000-11**
 13,0 cm, 5" **03-11-000-13**
 14,5 cm, 5¾" **03-11-000-14**
 15,5 cm, 6" **03-11-000-15**
 16,5 cm, 6½" **03-11-000-16**
 18,5 cm, 7¼" **03-11-000-18**
 20,0 cm, 8" **03-11-000-20**

STANDARD



10,5 cm, 4¼" **03-11-001-10**
 11,5 cm, 4½" **03-11-001-11**
 13,0 cm, 5" **03-11-001-13**
 14,5 cm, 5¾" **03-11-001-14**
 15,5 cm, 6" **03-11-001-15**
 16,5 cm, 6½" **03-11-001-16**
 18,5 cm, 7¼" **03-11-001-18**
 20,0 cm, 8" **03-11-001-20**

STANDARD

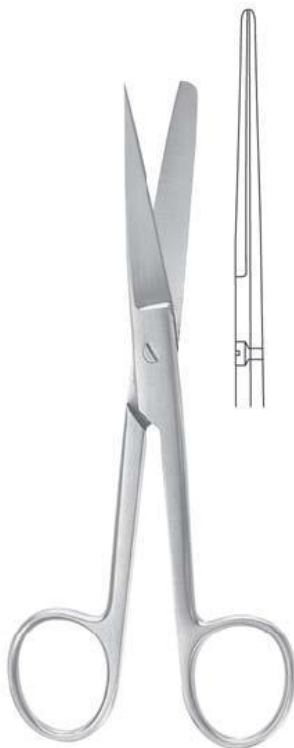

10,5 cm, 4¼" **03-11-002-10**
 11,5 cm, 4½" **03-11-002-11**
 13,0 cm, 5" **03-11-002-13**
 14,5 cm, 5¾" **03-11-002-14**
 15,5 cm, 6" **03-11-002-15**
 16,5 cm, 6½" **03-11-002-16**
 18,5 cm, 7¼" **03-11-002-18**
 20,0 cm, 8" **03-11-002-20**

STANDARD



10,5 cm, 4¼" **03-11-003-10**
 11,5 cm, 4½" **03-11-003-11**
 13,0 cm, 5" **03-11-003-13**
 14,5 cm, 5¾" **03-11-003-14**
 15,5 cm, 6" **03-11-003-15**
 16,5 cm, 6½" **03-11-003-16**
 18,5 cm, 7¼" **03-11-003-18**
 20,0 cm, 8" **03-11-003-20**

STANDARD

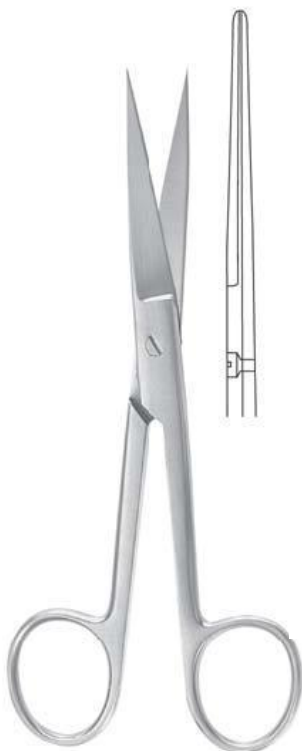

STANDARD

10,5 cm, 4¼" **03-11-004-10**
 11,5 cm, 4½" **03-11-004-11**
 13,0 cm, 5" **03-11-004-13**
 14,5 cm, 5¾" **03-11-004-14**
 15,5 cm, 6" **03-11-004-15**
 16,5 cm, 6½" **03-11-004-16**
 18,5 cm, 7¼" **03-11-004-18**
 20,0 cm, 8" **03-11-004-20**



STANDARD

10,5 cm, 4¼" **03-11-005-10**
 11,5 cm, 4½" **03-11-005-11**
 13,0 cm, 5" **03-11-005-13**
 14,5 cm, 5¾" **03-11-005-14**
 15,5 cm, 6" **03-11-005-15**
 16,5 cm, 6½" **03-11-005-16**
 17,5 cm, 7" **03-11-005-17**
 18,5 cm, 7¼" **03-11-005-18**
 20,0 cm, 8" **03-11-005-20**



DEAVER

12,0 cm, 4¾" **03-11-050-12**
 13,0 cm, 5" **03-11-050-13**
 14,5 cm, 5¾" **03-11-050-14**



DEAVER

12,0 cm, 4¾" **03-11-051-12**
 13,0 cm, 5" **03-11-051-13**
 14,5 cm, 5¾" **03-11-051-14**

Präparierscheren
 Dissecting Scissors
 Ciseaux à dissection
 Tijeras de disección
 Ножницы анатомические



12,0 cm, 4³/₄" **03-11-052-12**
 13,0 cm, 5" **03-11-052-13**
 14,5 cm, 5³/₄" **03-11-052-14**

DEAVER



12,0 cm, 4³/₄" **03-11-053-12**
 13,0 cm, 5" **03-11-053-13**
 14,5 cm, 5³/₄" **03-11-053-14**

DEAVER



12,0 cm, 4³/₄" **03-11-054-12**
 13,0 cm, 5" **03-11-054-13**
 14,5 cm, 5³/₄" **03-11-054-14**

DEAVER

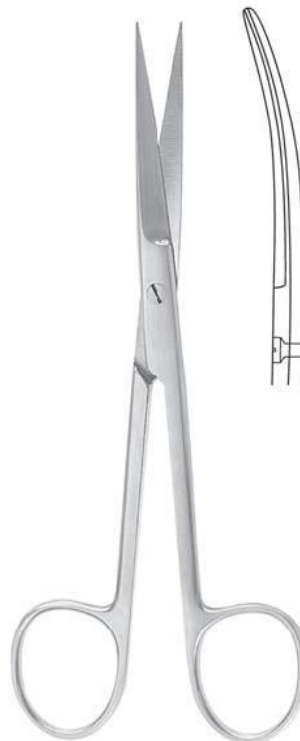

12,0 cm, 4³/₄" **03-11-055-12**
 13,0 cm, 5" **03-11-055-13**
 14,5 cm, 5³/₄" **03-11-055-14**

DEAVER



13,0 cm, 5" 03-11-070-13
 14,5 cm, 5¾" 03-11-070-14

GRAZIL



13,0 cm, 5" 03-11-071-13
 14,5 cm, 5¾" 03-11-071-14

GRAZIL



13,0 cm, 5" 03-11-072-13
 14,5 cm, 5¾" 03-11-072-14

GRAZIL



13,0 cm, 5" 03-11-073-13
 14,5 cm, 5¾" 03-11-073-14

GRAZIL

Präparierscheren
Dissecting Scissors
Ciseaux à dissection
Tijeras de disección
Ножницы анатомические

3



13,0 cm, 5" **03-11-074-13**
 14,5 cm, 5¾" **03-11-074-14**

GRAZIL



13,0 cm, 5" **03-11-075-13**
 14,5 cm, 5¾" **03-11-075-14**

GRAZIL

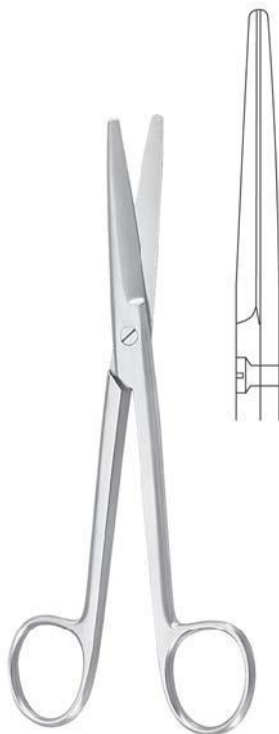

14,5 cm, 5¾" **03-11-100-14**
 15,5 cm, 6" **03-11-100-15**
 17,0 cm, 6¾" **03-11-100-17**
 19,0 cm, 7½" **03-11-100-19**
 23,0 cm, 9" **03-11-100-23**
 28,0 cm, 11" **03-11-100-28**

MAYO

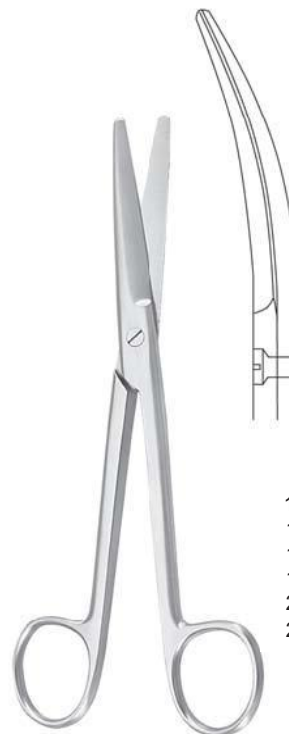

14,5 cm, 5¾" **03-11-101-14**
 15,5 cm, 6" **03-11-101-15**
 17,0 cm, 6¾" **03-11-101-17**
 19,0 cm, 7½" **03-11-101-19**
 23,0 cm, 9" **03-11-101-23**
 28,0 cm, 11" **03-11-101-28**

MAYO



15,0 cm, 6" 03-11-102-15
 17,0 cm, 6³/₄" 03-11-102-17
 19,5 cm, 7³/₄" 03-11-102-19
 21,0 cm, 8¹/₄" 03-11-102-21

MAYO-STILE

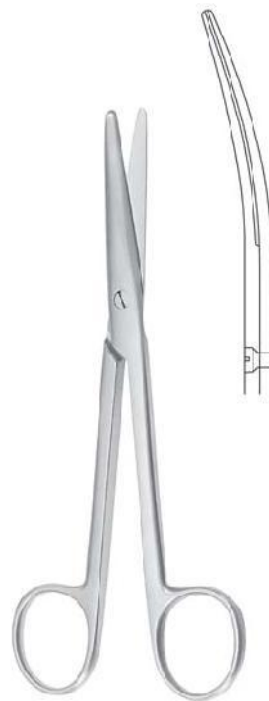

15,0 cm, 6" 03-11-103-15
 17,0 cm, 6³/₄" 03-11-103-17
 19,5 cm, 7³/₄" 03-11-103-19
 21,0 cm, 8¹/₄" 03-11-103-21

MAYO-STILE



03-11-104-17

MAYO-NOBLE
 17,0 cm, 6³/₄"



03-11-105-17



FOMON
 13,5 cm, 5³/₈"
 03-11-009-13

Präparierscheren
Dissecting Scissors
Ciseaux à dissection
Tijeras de disección
Ножницы анатомические

3



BABY-METZENBAUM
11,5 cm, 4½"

03-11-110-11



03-11-111-11



METZENBAUM-NELSON

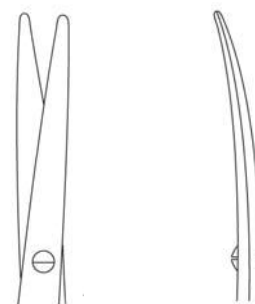

| | | |
|---------------|--------------|--------------|
| 18,0 cm, 7" | 03-11-116-18 | 03-11-117-18 |
| 20,0 cm, 8" | 03-11-116-20 | 03-11-117-20 |
| 23,0 cm, 9" | 03-11-116-23 | 03-11-117-23 |
| 26,0 cm, 10½" | 03-11-116-26 | 03-11-117-26 |
| 28,0 cm, 11" | 03-11-116-28 | 03-11-117-28 |
| 30,0 cm, 12" | 03-11-116-30 | 03-11-117-30 |
| 36,0 cm, 15" | 03-11-116-36 | 03-11-117-36 |



METZENBAUM

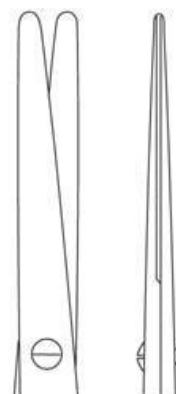

| | |
|--------------|--------------|
| 12,5 cm 4¾" | 03-11-110-12 |
| 14,5 cm, 5¾" | 03-11-110-14 |
| 18,0 cm, 7" | 03-11-110-18 |
| 20,0 cm, 8" | 03-11-110-20 |
| 23,0 cm, 9" | 03-11-110-23 |
| 25,0 cm, 10" | 03-11-110-25 |
| 28,0 cm, 11" | 03-11-110-28 |



METZENBAUM



| | |
|--------------|--------------|
| 12,5 cm 4¾" | 03-11-111-12 |
| 14,5 cm, 5¾" | 03-11-111-14 |
| 18,0 cm, 7" | 03-11-111-18 |
| 20,0 cm, 8" | 03-11-111-20 |
| 23,0 cm, 9" | 03-11-111-23 |
| 25,0 cm, 10" | 03-11-111-25 |
| 28,0 cm, 11" | 03-11-111-28 |
| 30,0 cm, 12" | 03-11-111-30 |



14,5 cm, 5¾" **03-11-112-14**
 18,0 cm, 7" **03-11-112-18**
 20,0 cm, 8" **03-11-112-20**
 23,0 cm, 9" **03-11-112-23**
 25,0 cm, 10" **03-11-112-25**
 30,0 cm, 12" **03-11-112-30**

METZENBAUM

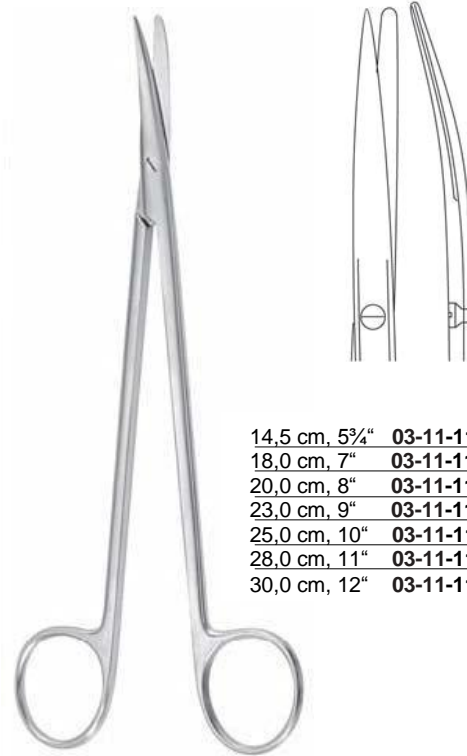

14,5 cm, 5¾" **03-11-113-14**
 18,0 cm, 7" **03-11-113-18**
 20,0 cm, 8" **03-11-113-20**
 23,0 cm, 9" **03-11-113-23**
 25,0 cm, 10" **03-11-113-25**
 28,0 cm, 11" **03-11-113-28**
 30,0 cm, 12" **03-11-113-30**

METZENBAUM



12,5 cm, 4¾" **03-11-114-12**
 14,5 cm, 5¾" **03-11-114-14**
 18,0 cm, 7" **03-11-114-18**
 20,0 cm, 8" **03-11-114-20**
 23,0 cm, 9" **03-11-114-23**
 25,0 cm, 10" **03-11-114-25**
 28,0 cm, 11" **03-11-114-28**
 30,0 cm, 12" **03-11-114-30**

METZENBAUM



12,5 cm, 4¾" **03-11-115-12**
 14,5 cm, 5¾" **03-11-115-14**
 18,0 cm, 7" **03-11-115-18**
 20,0 cm, 8" **03-11-115-20**
 23,0 cm, 9" **03-11-115-23**
 25,0 cm, 10" **03-11-115-25**
 28,0 cm, 11" **03-11-115-28**
 30,0 cm, 12" **03-11-115-30**

METZENBAUM



Präparierscheren
Dissecting Scissors
Ciseaux à dissection
Tijeras de disección
Ножницы анатомические

3

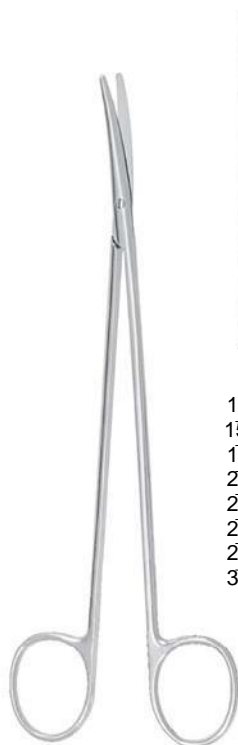

- 14,5 cm, 5¾" 03-11-121-14
- 15,5 cm, 6¾" 03-11-121-15
- 18,0 cm, 7" 03-11-121-18
- 20,0 cm, 8" 03-11-121-20
- 23,0 cm, 9" 03-11-121-23
- 25,0 cm, 10" 03-11-121-25
- 28,0 cm, 11" 03-11-121-28
- 30,0 cm, 12" 03-11-121-30

METZENBAUM-FINO



- 14,5 cm, 5¾" 03-11-120-14
- 15,5 cm, 6¾" 03-11-120-15
- 18,0 cm, 7" 03-11-120-18
- 20,0 cm, 8" 03-11-120-20
- 23,0 cm, 9" 03-11-120-23
- 25,0 cm, 10" 03-11-120-25
- 28,0 cm, 11" 03-11-120-28
- 30,0 cm, 12" 03-11-120-30

METZENBAUM-FINO



- 14,5 cm, 5¾" 03-11-124-14
- 18,0 cm, 7" 03-11-124-18
- 20,0 cm, 8" 03-11-124-20
- 23,0 cm, 9" 03-11-124-23

METZENBAUM-FINO



- 14,5 cm, 5¾" 03-11-125-14
- 18,0 cm, 7" 03-11-125-18
- 20,0 cm, 8" 03-11-125-20
- 23,0 cm, 9" 03-11-125-23

METZENBAUM-FINO

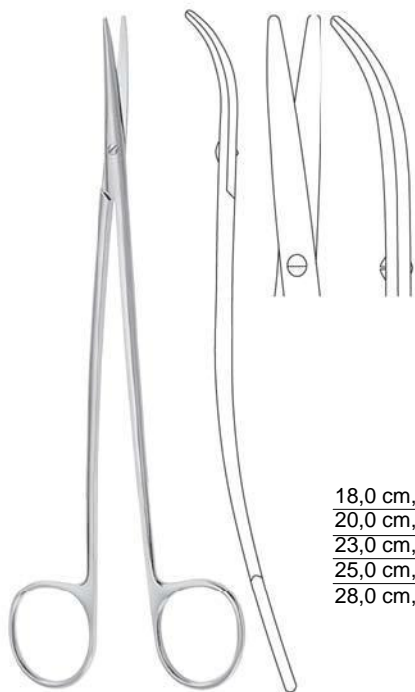

18,0 cm, 7" **03-11-127-18**
 20,0 cm, 8" **03-11-127-20**
 23,0 cm, 9" **03-11-127-23**
 25,0 cm, 10" **03-11-127-25**
 28,0 cm, 11" **03-11-127-28**

METZENBAUM-FINO S



18,0 cm, 7" **03-11-129-18**
 20,0 cm, 8" **03-11-129-20**
 23,0 cm, 9" **03-11-129-23**

METZENBAUM-FINO S



METZENBAUM-LAHEY
 14,0 cm, 5½"
03-11-137-14

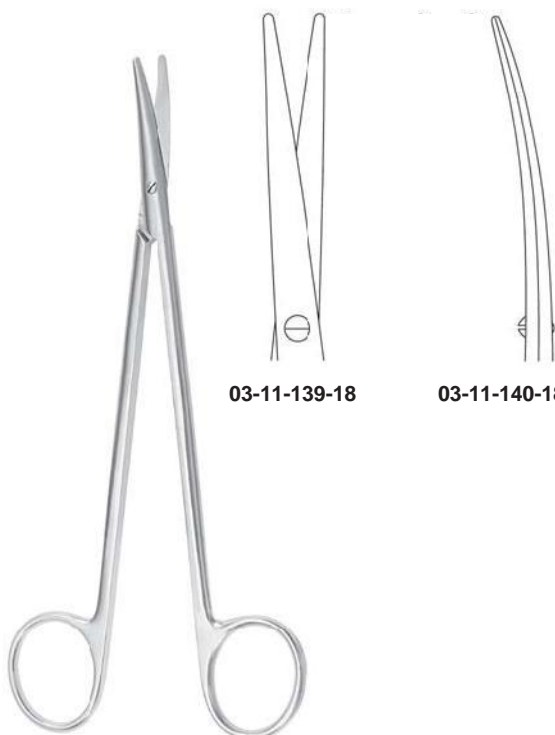

03-11-139-18

03-11-140-18

TOENNIS-ADSON
 18,0 cm, 7"

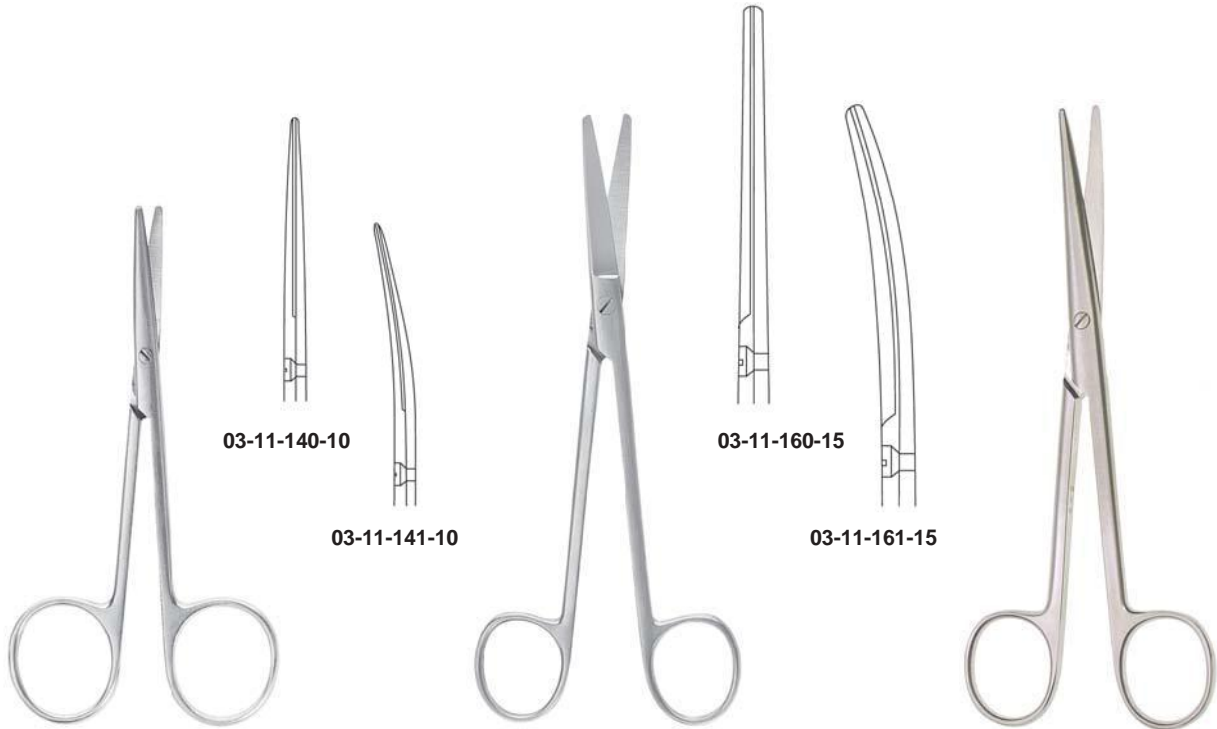

BABY-LEXER
 10,0 cm, 4"

03-11-140-10

03-11-141-10

MIXTER
 15,5 cm, 6"

03-11-160-15

03-11-161-15

LEXER-FINO
 16,5 cm, 6½"
 03-11-143-16



LEXER

16,0 cm, 6¼" 03-11-140-16
 21,0 cm, 8¼" 03-11-140-21



LEXER

16,0 cm, 6¼" 03-11-141-16
 21,0 cm, 8¼" 03-11-141-21



mit flacher Spitze
 smath with flat
 point lisses
 pointe plat
 с плоскими концами

- 12,0 cm, 4¾" 03-11-200-12
- 15,0 cm, 6" 03-11-200-15
- 18,0 cm, 7" 03-11-200-18
- 20,0 cm, 8" 03-11-200-20

KILNER (RAGNELL)



mit flacher Spitze
 smath with flat
 point lisses
 pointe plat
 с плоскими концами

- 12,0 cm, 4¾" 03-11-201-12
- 15,0 cm, 6" 03-11-201-15
- 18,0 cm, 7" 03-11-201-18
- 20,0 cm, 8" 03-11-201-20

KILNER (RAGNELL)



- 14,0 cm 5¼" 03-11-210-14.0
- 14,5 cm, 5¾" 03-11-210-14
- 15,5 cm, 5⅝" 03-11-210-15
- 16,0 cm, 6¼" 03-11-210-16
- 18,0 cm, 7" 03-11-210-18
- 20,0 cm, 8" 03-11-210-20
- 23,0 cm, 9" 03-11-210-23
- 25,0 cm, 10" 03-11-210-25



- 14,5 cm, 5¾" 03-11-211-14
- 16,0 cm, 6¼" 03-11-211-16
- 18,0 cm, 7" 03-11-211-18



REYNOLDS



FOMON SPEZIAL
 13,5 cm, 4¾"
 03-11-013-13

Feine chirurgische Scheren
 Fine surgical scissors
 Fins Ciseaux chirurgicaux
 Tijeras fi nas para cirugia
 Тонкие хирургические ножницы



18,0 cm, 7" 03-11-217-18
 23,0 cm, 10" 03-11-217-23
 25,0 cm, 10" 03-11-217-25

THOREK



15,0 cm, 6"

03-11-220-15

03-11-221-15

Nerv-Präparierscheren
 Nerve dissecting scissors
 Ciseaux pour nerfs Tijeras
 para nervios Ножницы
 для сухожилия



SANVENERO
 14,0 cm, 5½"

03-11-224-14

03-11-225-14

extra flache Blätter
 extra flat blades
 lames extrêmement plat
 hojas muy delgadas
 особо плоские бранши



JOSEPH
 14,0 cm, 5½"

03-11-228-14

03-11-229-14





Feine chirurgische Scheren
Fine surgical scissors
Fins ciseaux chirurgicaux
Tijeras finas para cirugía
Тонкие хирургические ножницы

3



9,0 cm, 3½" 03-11-244-09
10,5 cm, 4⅞" 03-11-244-10
11,5 cm, 4½" 03-11-244-11

IRIS

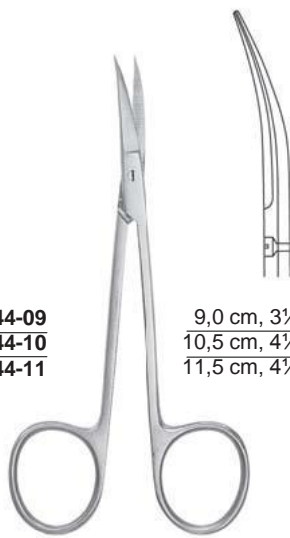

9,0 cm, 3½" 03-11-245-09
10,5 cm, 4⅞" 03-11-245-10
11,5 cm, 4½" 03-11-245-11

IRIS



10,5 cm, 4⅞" 03-11-250-10
11,5 cm, 4½" 03-11-250-11

IRIS



10,5 cm, 4⅞" 03-11-251-10
11,5 cm, 4½" 03-11-251-11

IRIS



IRIS
11,5 cm, 4½" 03-11-261-11



IRIS
11,5 cm, 4½" 03-11-263-11



03-11-264-12

12,0 cm, 4¾"



03-11-265-12



MOD. BONN
 8,0 cm, 3¼"
 03-11-270-08



MOD. BONN
 8,0 cm, 3¼"
 03-11-271-08



MOD. BONN
 8,0 cm, 3¼"
 03-11-272-08

Chirurgische Scheren, Feine chirurgische Scheren
 Surgical scissors, Fine surgical scissors
 Ciseaux chirurgicaux, Fins ciseaux chirurgicaux
 Tijeras para cirugía, Tijeras finas para cirugía
 Хирургические ножницы, тонкие хирургические ножницы



BROPHY (SULLIVAN)
 FLACHSCHLUSS
 14,0 cm, 5½"
 03-11-276-14



BROPHY (SULLIVAN)
 FLACHSCHLUSS
 14,0 cm, 5½"
 03-11-277-14



Inzisionscheren
 Incisionscissors
 Ciseaux a incision
 Tijeras para incisión
 Ножницы для рассечения
 тканей

13,0 cm, 5" 03-11-300-13
 14,5 cm, 5¾" 03-11-300-14
 16,0 cm, 6½" 03-11-300-16
 16,5 cm, 6¾" 03-11-302-16



FERGUSSON
 16,5 cm, 6¼" 03-11-315-16
 18,0 cm, 7" 03-11-315-18



TOENNIS
 18,0 cm, 7"
 03-11-324-18



TOENNIS
 18,0 cm, 7"
 03-11-325-18



SHORTHBENT
 9,0 cm, 3½"
 03-11-411-09



NORTHBENT
 12,5 cm, 4¾"
 03-11-413-13



EISELSBERG
 12,0 cm, 4¼"
 03-11-415-12



03-11-450-22

STRULLY
 22,0 cm, 8⅝"
 03-11-450-22

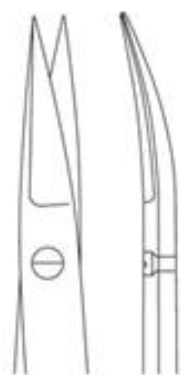

03-11-452-22

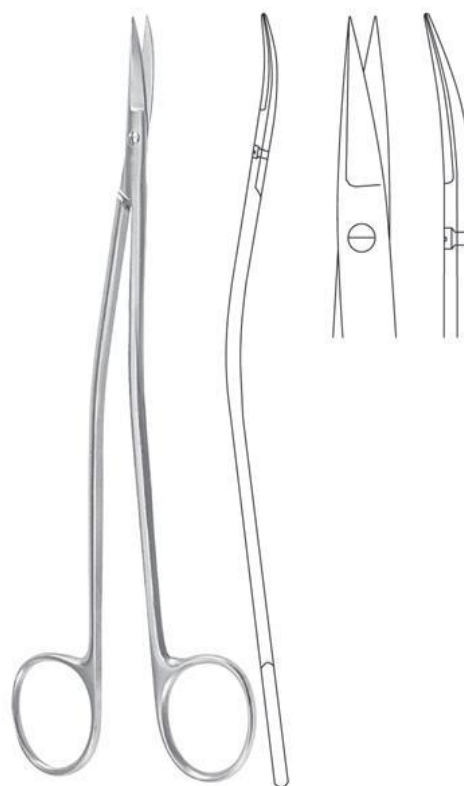

DANDY
 17,0 cm, 6¾"
 03-11-453-17

Chirurgische Scheren, Ligaturscheren
 Surgical scissors, Ligature Scissors
 Ciseaux chirurgicaux, Ciseaux a sutures
 Tijeras para cirugía, Tijeras para ligaduras
 Ножницы хирургические, лигатурные ножницы

3



HALLE
 14,0 cm, 5½" **03-11-341-14**
 19,0 cm, 7½" **03-11-341-19**



FOMON
 13,0 cm, 5"
03-11-343-13



FOMON SABER BACK
 13,5 cm, 5"
03-11-015-13



SPENCER
 9,0 cm, 4¼" **03-11-400-09**
 11,0 cm, 4¾" **03-11-400-11**
 12,0 cm 5" **03-11-398-12**
 12,5 cm 5½" **03-11-400-12**
 16,0 cm, 6½" **03-11-400-16**



LITTAUER
 14,0 cm, 5½" **03-11-402-14**
 16,0 cm, 6¼" **03-11-402-16**



BUCK

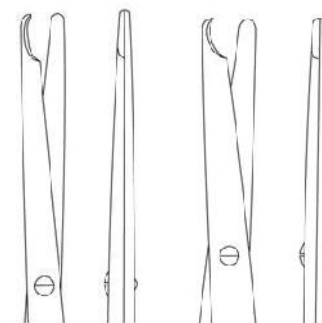

14,5 cm, 5¾"
03-11-404-14

18,0 cm, 7"
03-11-404-18

Tonsillenscheren, Nasenscheren, Neurochirurgische Scheren
Tonsil Scissors, Nasal Scissors Neurosurgical Scissors
Ciseaux amygdaliens, Ciseaux a énucléation et nasaux, Ciseaux neurochirurgicaux
Tijeras para amígdalas, Tijeras para el tabique nasal, Tijeras para Neurocirugía
Ножницы для миндалин, носовые ножницы, нейрохирургические ножницы

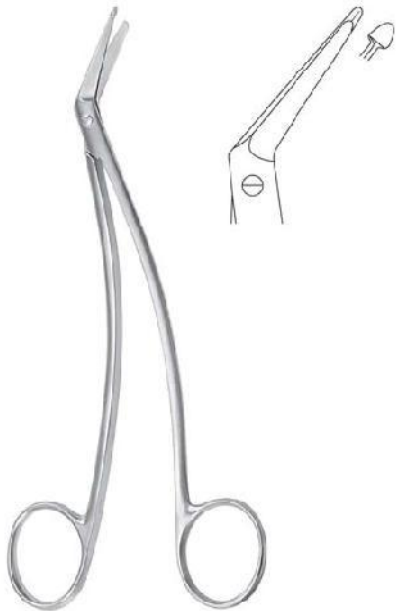

SCHMIEDEN-TAYLOR
14,5 cm, 5¾" **03-11-501-18**
17,0 cm, 6¾" **03-11-457-17**



LINCOLN
 17,0 cm, 6¾"



HEYMANN
18,0 cm, 7" **03-11-501-18**
19,0 cm, 7½" **03-11-501-19**

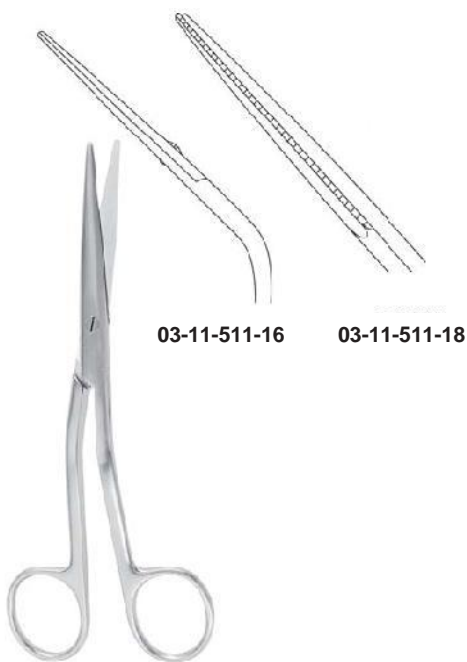

COTTLE
 16,0 cm, 6¼"



HEYMANN
WELLENSCHLIFF
18,0 cm, 7" **03-11-517-18**
19,0 cm, 7½" **03-11-517-19**



CAPLAN
 22,0 cm, 8⅝"
03-11-519-22

Tonsillenscheren, Nasenscheren, Gefäßscheren
Tonsil Scissors, Nasal Scissors, Vascular Scissors
Ciseaux amygdaliens, Ciseaux a énucléation et nasaux, Ciseaux vasculaires
Tijeras para amígdalas, Tijeras para el tabique nasal, Tijeras vasculares
Ножницы для миндалин, носовые ножницы, ножницы для кровеносных сосудов



BOETTCHER
 18,0 cm, 7"
 03-11-521-18



PRINCE
 17,5 cm, 6 7/8"
 03-11-523-17



03-11-524-19

03-11-525-19

GOOD
 19,0 cm, 7 1/2"



CARTILAGE
 20,0 cm, 8"
 03-11-528-20

gezahnt
 serrated
 dentées
 dentada
 зазубренные



DE BAKAY

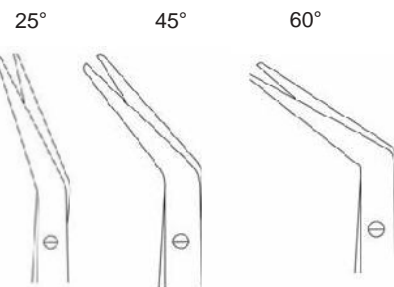

| | | | |
|-----------------|--------------|--------------|--------------|
| 17,5 cm, 6 7/8" | 03-11-540-25 | 03-11-540-45 | 03-11-540-60 |
| 19,5 cm, 7" | 03-11-541-25 | 03-11-541-45 | 03-11-541-60 |
| 21,0 cm, 8 1/4" | 03-11-543-25 | 03-11-543-45 | - |
| 23,0 cm, 9" | 03-11-544-25 | 03-11-544-45 | 03-11-544-60 |
| 28,0 cm, 11" | 03-11-545-25 | 03-11-545-45 | 03-11-545-60 |



DIETHRICH
 17,0 cm, 6¾"
03-11-552-12

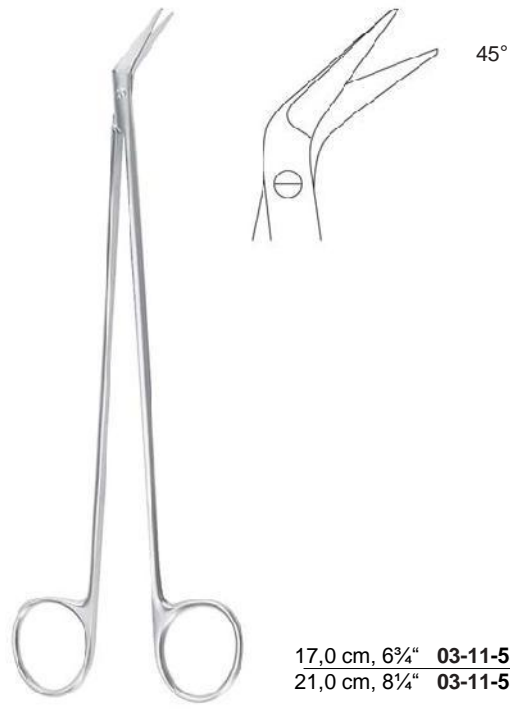

POTTS DE MARTEL

17,0 cm, 6¾" **03-11-548-17**
 21,0 cm, 8¼" **03-11-548-21**



DIETHRICH-HEGEMANN

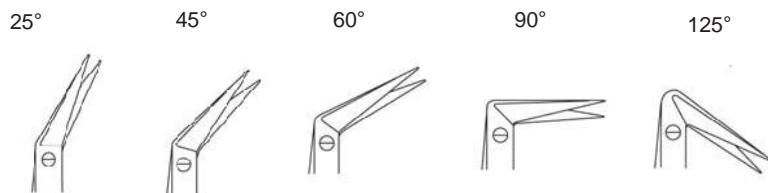

| | 25° | 45° | 60° | 90° | 125° |
|---------------|-----------------------|-----------------------|-----------------------|-----------------------|-----------------------|
| 13,0 cm, 5" | 03-11-550-25 | 03-11-550-45 | 03-11-550-60 | 03-11-550-90 | - |
| 13,5 cm, 5 ¼" | 03-11-563-25 | 03-11-563-45 | 03-11-563-60 | 03-11-563-90 | |
| 16,0 cm, 6¼" | 03-11-550-25.1 | 03-11-550-45.1 | 03-11-550-60.1 | 03-11-550-90.1 | 03-11-550-12.1 |
| 19,0 cm, 7½" | 03-11-550-25.2 | 03-11-550-45.2 | 03-11-550-60.2 | 03-11-550-90.2 | 03-11-550-12.2 |

**Gefäßscheren Vascular
Scissors Ciseaux
vasculaires Tijeras
vasculares Ножницы
для сосудов**

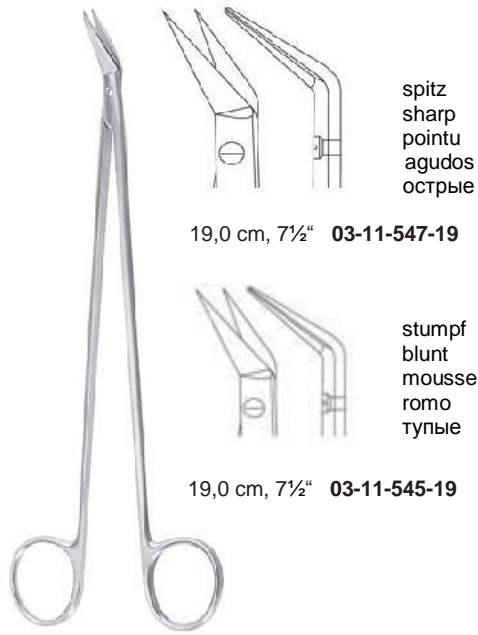

19,0 cm, 7½" 03-11-547-19

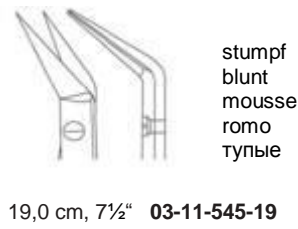

19,0 cm, 7½" 03-11-545-19

POTTS-SMITH



POTTS-SMITH
19,0 cm, 7½"



25°

16,0 cm, 6½" 03-11-552-25
19,0 cm, 7½" 03-11-553-25



45°

03-11-553-45



60°

03-11-553-60



DE BAKEY
15,5 cm, 6¼"
03-11-560-15



DE BAKEY
15,5 cm, 6¼"
03-11-561-15

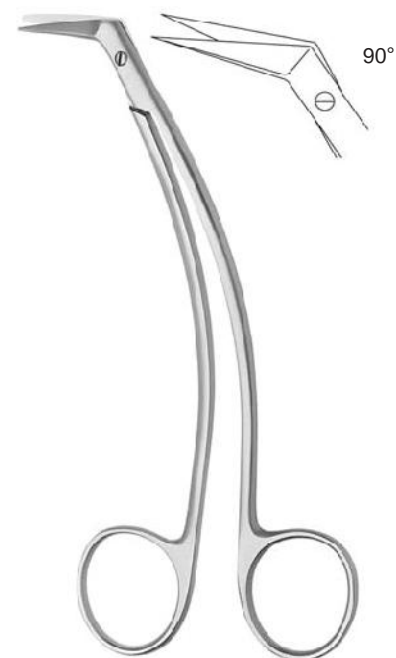

FAVALORO
15,0 cm, 6"
03-11-562-15



MC INDOE
 19,0 cm, 7½"
 03-11-570-19



geknöpftes Blatt
 probe-pointed blade
 una lame boutonnée
 punta botonda
 застегивающиеся
 лезвия

11,5 cm, 4½"
 03-11-572-11



CRAFOORD
 30,0 cm, 12"
 03-11-575-30



SATINSKY
 25,0 cm, 10"
 03-11-577-25



KLINGENBERG-LOTH
 23,0 cm, 9"
 03-11-579-23



SIMS

| | | | |
|--------------|--------------|--------------|--------------|
| 20,0 cm, 8" | 03-11-600-20 | 03-11-602-20 | 03-11-604-20 |
| 21,5 cm, 8½" | 03-11-600-21 | 03-11-602-21 | 03-11-604-21 |
| 23,0 cm, 9" | 03-11-600-23 | 03-11-602-23 | 03-11-604-23 |



Gynäkologische Scheren
 Gynecological scissors
 Ciseaux gynécologiques
 Tijeras para ginecología
 Ножницы гинекологические

3



SIMS



gebogen, curved, arquée, curva, изогнутые

| | | | |
|-------------|---------------------|---------------------|---------------------|
| 20,0 cm, 8" | 03-11-601-20 | 03-11-603-20 | 03-11-605-20 |
| 23,0 cm, 9" | 03-11-601-23 | 03-11-603-23 | 03-11-605-23 |



SIEBOLD
 24,0 cm, 9½"
03-11-620-24



DOYEN



| | | | |
|--------------|---------------------|---------------------|---------------------|
| 16,0 cm, 6¼" | 03-11-610-16 | 03-11-611-16 | 03-11-612-16 |
| 17,5 cm, 6¾" | 03-11-610-17 | 03-11-611-17 | - |



BOZEMANN
 22,0 cm, 8¾"
03-11-622-22

Gynäkologische Scheren, Dammscheren
Gynecological scissors, Enterotomy Scissors
Ciseaux gynécologiques, Ciseaux intestinaux
Tijeras para ginecología, Tijeras enterótomos
Ножницы гинекологические, ножницы кишечные



Fistelscheren Fistula
 scissors Ciseaux a
 fistules Tijeras para
 fi stulas
 Ножницы для фистулы

KELLY

16,0 cm, 6¼" **03-11-634-16**
 18,0 cm, 7" **03-11-634-18**
TC
 16,0 cm, 6¼" **03-12-634-16**



Fistelscheren
 Fistula scissors
 Ciseaux a fistules
 Tijeras para fi stulas
 Ножницы для фистулы

KELLY

16,0 cm, 6¼" **03-11-635-16**
 18,0 cm, 7" **03-11-635-18**
TC
 16,0 cm, 6¼" **03-12-635-16**



03-11-651-27

gebogen
 curved
 arquée
 curva
 изогнутые

DUBOIS

27,0 cm, 10¾"
03-11-650-27



LLOYD-DAVIES
 27,0 cm, 10¾"
03-11-677-27



21,0 cm, 8¼"
03-11-0670-21



21,0 cm, 8¼"
03-11-672-21



21,0 cm, 8¼"
03-11-674-21

Лungenlappen- und Rektumscheren, Lungenscheren, Dammscheren
Lobectomy and Rectal Scissors, Lobectomy Scissors, Episiotomy Scissors
Lobectomie et rectale ciseaux, Ciseaux intestinaux, Episiotomy Scissors,
Tijeras para lobectomía y recto, Tijera para lobectomía, Tijeras para episiotomía
Ножницы ректальные, ножницы для лобэктомии, ножницы для легких

3



STELZNER
 31,0 cm, 12¼"
 03-11-681-31



RECTAL
 30,5 cm, 11½" 03-11-685-30
 32,5 cm 12¾" 03-11-685-32



WILLAUER
 25,0 cm, 9¾" 03-11-688-25
 28,0 cm, 11" 03-11-688-28



WILLAUER
 25,0 cm, 9¾" 03-11-689-25
 28,0 cm, 11" 03-11-689-28



POTTS-SMITH
 19,0 cm, 7½"
 03-11-691-19



FINOCHIETTO
 32,5 cm, 10¾"
 03-11-693-32

Lungenscheren, Dammscheren, Nabelschnurscheren
Lobectomy Scissors, Episiotomy Scissors, Umbilical Cord Scissors
Lobectomie ciseaux, Ciseaux intestinaux, Ciseaux ombilicales
Tijera para lobectomía, Tijeras para episiotomía, Tijeras umbilicales
Ножницы для лобэктомии и эпизиотомии, ножницы для обрезания пуповины



WALDMANN
 18,0 cm, 7"
03-11-695-18



BRAUN-STADLER
 14,5 cm, 5¾" **03-11-701-14**
 20,0 cm, 8" **03-11-701-20**
 22,0 cm, 8¾" **03-11-701-22**



20,0 cm, 8"
03-11-703-20



MOD. USA
 10,5 cm, 4¼"
03-11-706-10



BUSCH
 13,5 cm, 5⅜" **03-11-707-13**
 16,0 cm, 6¼" **03-11-707-16**



SCHUMACHER
 16,0 cm, 16¼"
03-11-709-16

Drahtscheren, Verband- und Kleiderstoffscheren
Wire Scissors, Bandage and Cloth Scissors
Ciseaux a Fils, Ciseaux a Bandages, Ciseaux a Gaze
Cizallas corta-alambres, Tijeras para vendajes y tela
Ножницы для проволоки, ножницы для повязок

3



gezahnt
 serrated
 dentelée
 dentada
 зазубренные

UNIVERSAL
 12,0 cm, 4¾"
 03-11-800-12



9,0 cm, 3½" 03-11-900-09
 11,0 cm, 4¾" 03-11-900-11
 14,0 cm, 5½" 03-11-900-14
 16,0 cm, 6¼" 03-11-900-16
 18,0 cm, 7" 03-11-900-18
 20,0 cm, 8" 03-11-900-20

LISTER



LISTER
 18,5 cm, 7¼" 03-11-901-18
 21,0 cm, 8¼" 03-11-901-21



LISTER-EXCENTRIC
 16,0 cm, 6¼" 03-11-903-16
 19,0 cm, 7½" 03-11-903-19

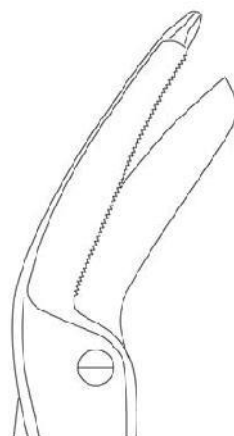

gezahnt
 serrated
 dentelée
 dentada
 зазубренные



BERGMANN
 23,0 cm, 9"
 03-11-905-23

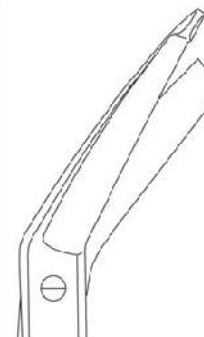

Verband- und Kleiderstoffscheren, Gipsscheren
Bandage and Cloth Scissors, Plaster-of-Paris Shears
Ciseaux a Bandages, Ciseaux a Gaze, Ciseaux a Plâtre
Tijeras para vendajes y tela, Cizallas para escayolas
Ножницы для повязок, ножницы для гипсовых повязок



ESMARCH
 20,0 cm, 8" **03-11-907-20**
 22,0 cm, 8 7/8" **03-11-907-22**

KNOWLES
 14,0 cm, 5 1/2"
03-11-920-14

BRUNS
 24,0 cm, 9 1/2"

03-11-909-24

gezahnt
 serrated
 dentelée
 dentada
 зазубренные

03-11-910-24

glatt
 smooth
 lisses
 lisas
 гладкие



LORENZ
 23,0 cm, 9"
03-11-930-23

20,0 cm, 8"
03-11-941-20

UNIVERSAL
 14,0 cm, 5 1/2" **03-11-950-14**
 16,0 cm, 6 1/4" **03-11-950-16**
 18,0 cm, 7" **03-11-950-18**

gezahnt
 serrated
 dentelée
 dentada
 зазубренные

gezahnt
 serrated
 dentelée
 dentada
 зазубренные

Chirurgische Scheren mit Hartmetallschneiden
 Surgical Scissors with tungsten carbide edges
 Ciseaux chirurgicaux, tranchant TC
 Tijeras para cirugía con filos de carburo tungsteno
 Ножницы хирургические с твердосплавной вставкой



3



STANDARD
 14,5 cm, 5¾" **03-12-000-14**
 16,5 cm, 6½" **03-12-000-16**
 18,5 cm, 7¼" **03-12-000-18**



STANDARD
 14,5 cm, 5¾" **03-12-001-14**
 16,5 cm, 6½" **03-12-001-16**
 18,5 cm, 7¼" **03-12-001-18**



STANDARD
 14,5 cm, 5¾" **03-12-002-14**
 16,5 cm, 6½" **03-12-002-16**
 18,5 cm, 7¼" **03-12-002-18**



STANDARD
 14,5 cm, 5¾" **03-12-003-14**
 16,5 cm, 6½" **03-12-003-16**
 18,5 cm, 7¼" **03-12-003-18**



STANDARD
 14,5 cm, 5¾" **03-12-004-14**
 16,5 cm, 6½" **03-12-004-16**
 18,5 cm, 7¼" **03-12-004-18**



STANDARD
 14,5 cm, 5¾" **03-12-005-14**
 16,5 cm, 6½" **03-12-005-16**
 18,5 cm, 7¼" **03-12-005-18**

Chirurgische Scheren mit Hartmetallschneiden
 Surgical Scissors with tungsten carbide edges
 Ciseaux chirurgicaux, tranchant TC
 Tijeras para cirugía con fi los de carburo tungsteno
 Ножницы хирургические с твердосплавной вставкой



MAYO

14,5 cm, 5¾" **03-12-100-14**
 16,0 cm, 6¼" **03-12-100-16**
 17,0 cm, 6¾" **03-12-100-17**
 19,0 cm, 7¼" **03-12-100-19**
 23,0 cm, 9" **03-12-100-23**



MAYO

14,5 cm, 5¾" **03-12-101-14**
 16,0 cm, 6¼" **03-12-101-16**
 17,0 cm, 6¾" **03-12-101-17**
 19,0 cm, 7¼" **03-12-101-19**
 23,0 cm, 9" **03-12-101-23**



MAYO-STILLE

15,0 cm, 6" **03-12-102-15**
 17,0 cm, 6¾" **03-12-102-17**



MAYO-STILLE

15,0 cm, 6" **03-12-103-15**
 17,0 cm, 6¾" **03-12-103-17**



LEXER

16,0 cm, 6¼" **03-12-140-16**
 21,0 cm, 8¼" **03-12-140-21**



LEXER

16,0 cm, 6¼" **03-12-141-16**
 21,0 cm, 8¼" **03-12-141-21**



Präparierscheren mit Hartmetallschneiden
 Dissecting Scissors with tungsten carbide edges
 Ciseaux à dissection, tranchant TC
 Tijeras para disección con fi los de carburo tungsteno
 Ножницы анатомические с твердосплавной вставкой



3



03-12-110-11



BABY-METZENBAUM
11,5 cm, 4½"



03-12-110-14



METZENBAUM
14,5 cm, 5¾"



03-12-112-18



METZENBAUM
18,0 cm, 7"



03-12-111-11



03-12-111-14



03-12-113-18



03-12-114-14



METZENBAUM
14,5 cm, 5¾"



18,0 cm, 7" 03-12-110-18
 20,0 cm, 8" 03-12-110-20
 23,0 cm, 9" 03-12-110-23
 25,0 cm, 10" 03-12-110-25
 28,0 cm, 11" 03-12-110-28
 30,0 cm, 12" 03-12-110-30



METZENBAUM



18,0 cm, 7" 03-12-111-18
 20,0 cm, 8" 03-12-111-20
 23,0 cm, 9" 03-12-111-23
 25,0 cm, 10" 03-12-111-25
 28,0 cm, 11" 03-12-111-28
 30,0 cm, 12" 03-12-111-30



METZENBAUM

Präparierscheren mit Hartmetallschneiden
Dissecting Scissors with tungsten carbide edges
Ciseaux à dissection, tranchant TC
Tijeras para disección con filos de carburo tungsteno
Ножницы анатомические с твердосплавной вставкой

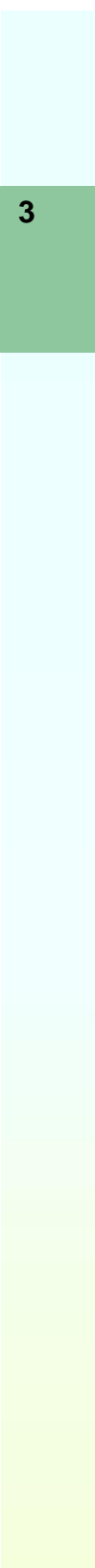

3



18,0 cm, 7" **03-12-114-18**
 20,0 cm, 8" **03-12-114-20**
 23,0 cm, 9" **03-12-114-23**

METZENBAUM



18,0 cm, 7" **03-12-115-18**
 20,0 cm, 8" **03-12-115-20**
 23,0 cm, 9" **03-12-115-23**

METZENBAUM

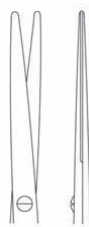

03-12-120-14



03-12-121-14

METZENBAUM-FINO
 14,5 cm, 5¾"



03-12-124-14



03-12-125-14

METZENBAUM-FINO
 14,5 cm, 5¾"

Präparierscheren mit Hartmetallschneiden
Dissecting Scissors with tungsten carbide edges
Ciseaux à dissection, tranchant TC
Tijeras para disección con fi los de carburo tungsteno
Ножницы анатомические с твердосплавной вставкой

3



18,0 cm, 7" **03-12-120-18**
 20,0 cm, 8" **03-12-120-20**
 23,0 cm, 9" **03-12-120-23**
 25,0 cm, 10" **03-12-120-25**
 28,0 cm, 11" **03-12-120-28**



METZENBAUM-FINO



18,0 cm, 7" **03-12-121-18**
 20,0 cm, 8" **03-12-121-20**
 23,0 cm, 9" **03-12-121-23**
 25,0 cm, 10" **03-12-121-25**
 28,0 cm, 11" **03-12-121-28**



METZENBAUM-FINO



18,0 cm, 7" **03-12-124-18**
 20,0 cm, 8" **03-12-124-20**
 23,0 cm, 9" **03-12-124-23**

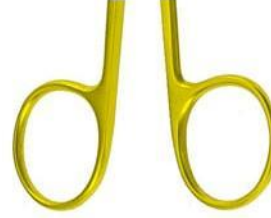

METZENBAUM-FINO



18,0 cm, 7" **03-12-125-18**
 20,0 cm, 8" **03-12-125-20**
 23,0 cm, 9" **03-12-125-23**



METZENBAUM-FINO



METZENBAUM-LAHEY
 14,0 cm, 5½"
03-12-137-14

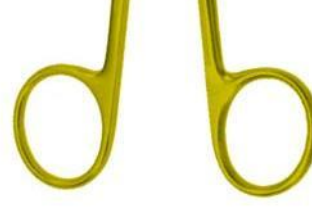

TOENNIS-ADSON
 17,0 cm, 6¾"
03-12-139-17

Präparierscheren mit Hartmetallschneiden
 Dissecting Scissors with tungsten carbide edges
 Ciseaux à dissection, tranchant TC
 Tijeras para disección con fi los de carburo tungsteno
 Ножницы анатомические с твердосплавной вставкой



18,0 cm, 7" 03-12-127-18
 20,0 cm, 8" 03-12-127-20
 23,0 cm, 9" 03-12-127-23

METZENBAUM-FINO S



18,0 cm, 7" 03-12-129-18
 20,0 cm, 8" 03-12-129-20
 23,0 cm, 9" 03-12-129-23

METZENBAUM-FINO S



HYSTEREKTOMY
 25,0 cm, 10"
 03-12-663-25



HYSTEREKTOMY
 27,0 cm, 10½"
 03-12-665-27



REYNOLDS

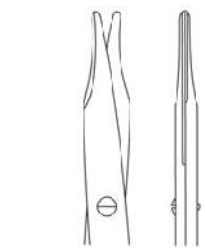

15,0 cm, 6" 03-12-210-15



14,5 cm, 5¾" 03-12-211-14
 18,0 cm, 7" 03-12-211-18



Gynäkologische Scheren mit Hartmetallschneiden
Gynecological scissors with tungsten carbide edges
Ciseaux gynécologiques, tranchant TC
Tijeras para ginecología con fi los de carburo tungsteno
Ножницы гинекологические с твердосплавной вставкой



3

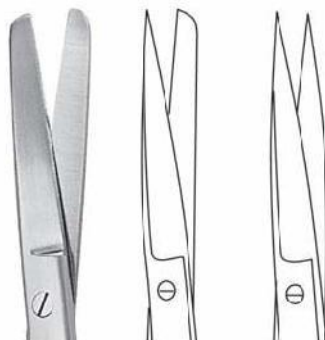

20,0 cm, 8" 03-12-600-20 03-12-602-20 03-12-604-20
23,0 cm, 9" 03-12-600-23 03-12-602-23 03-12-604-23

SIMS

gebogen, curved, arquée, curva, изогнутые



20,0 cm, 8" 03-12-601-20 03-12-603-20 03-12-605-20
23,0 cm, 9" 03-12-601-23 03-12-603-23 03-12-605-23

SIMS

Gefäßscheren mit Hartmetallschneiden
Vascular Scissors with tungsten carbide edges
Ciseaux vasculaires, tranchant TC
Tijeras vasculares con fi los de carburo tungsteno
Ножницы для кровеносных сосудов с твердосплавной вставкой



DIETHRICH
 19,0 cm, 7½"
03-12-552-19



POTTS DE MARTEL
 19,0 cm, 7½"
03-12-548-19

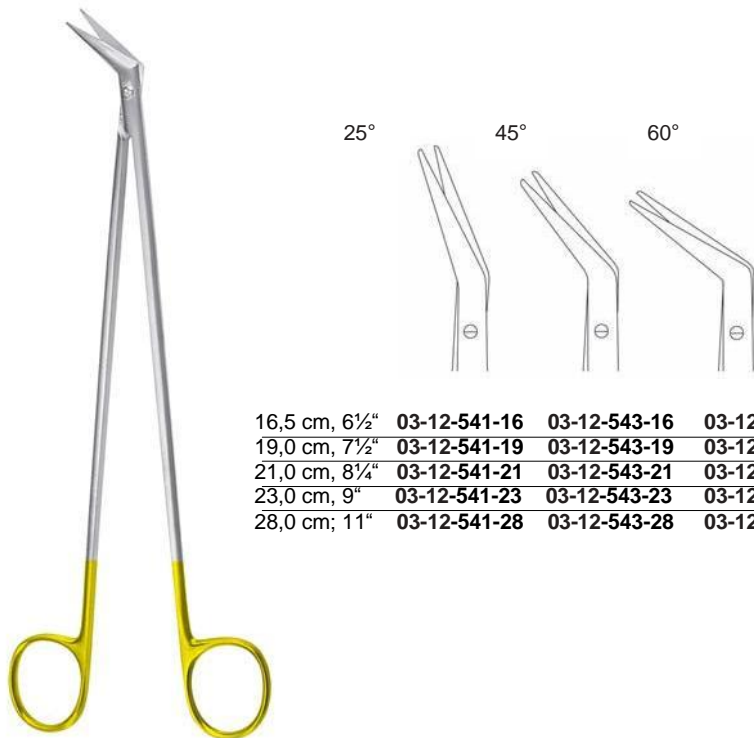

DE BAKHEY

| | | | |
|--------------|---------------------|---------------------|---------------------|
| 16,5 cm, 6½" | 03-12-541-16 | 03-12-543-16 | 03-12-545-16 |
| 19,0 cm, 7½" | 03-12-541-19 | 03-12-543-19 | 03-12-545-19 |
| 21,0 cm, 8¼" | 03-12-541-21 | 03-12-543-21 | 03-12-545-21 |
| 23,0 cm, 9" | 03-12-541-23 | 03-12-543-23 | 03-12-545-23 |
| 28,0 cm; 11" | 03-12-541-28 | 03-12-543-28 | 03-12-545-28 |

Gefäßscheren mit Hartmetallschneiden
Vascular Scissors with tungsten carbide edges
Ciseaux vasculaires, tranchant TC
Tijeras vasculares con fi los de carburo tungsteno
Ножницы для кровеносных сосудов с твердосплавной вставкой



3

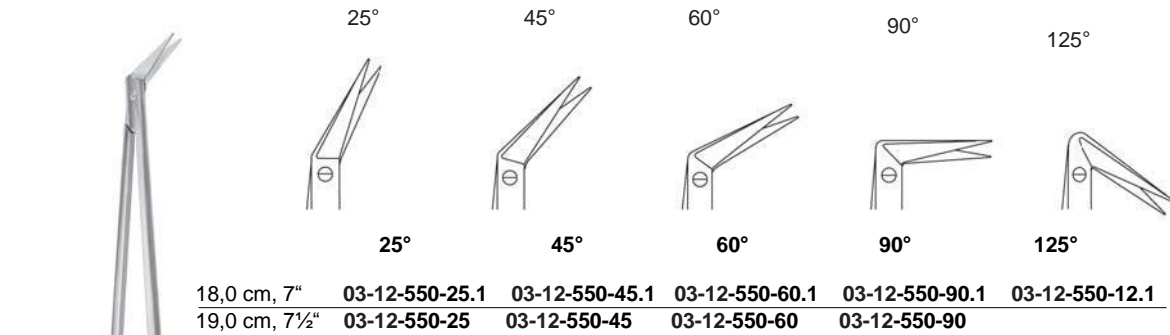

Gezahnt serrated dentelée dentada зазубренные

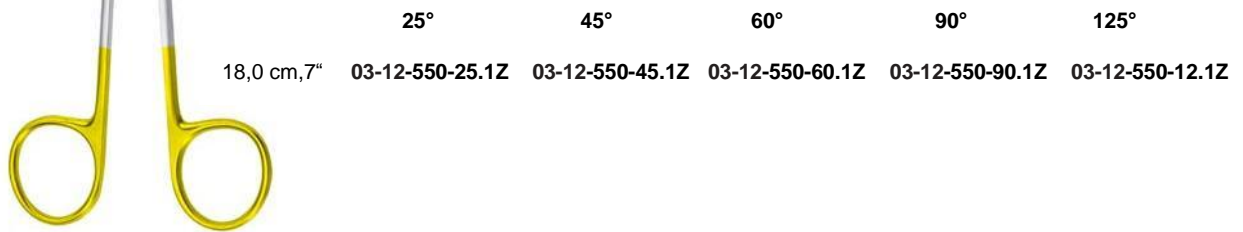

DIETRICH-HEGEMANN

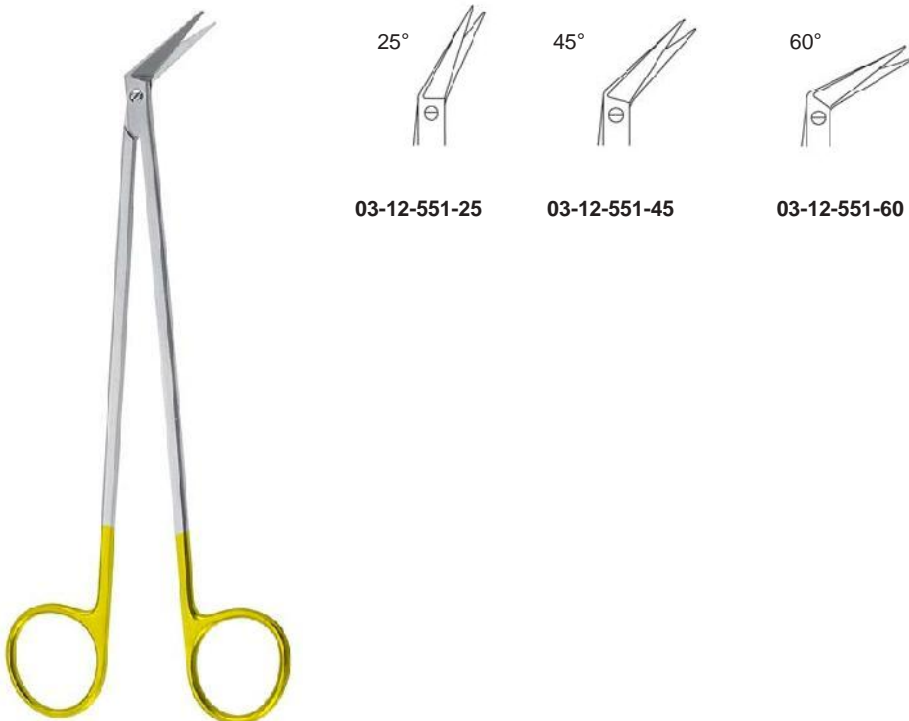

POTTS-SMITH
 19,0 cm, 7½"

Scheren mit Hartmetallschneide
 Scissors with tungsten carbide edges
 Ciseaux tranchant TC
 Tijeras con fi los de carburo tungsteno
 Ножницы с твердосплавной вставкой

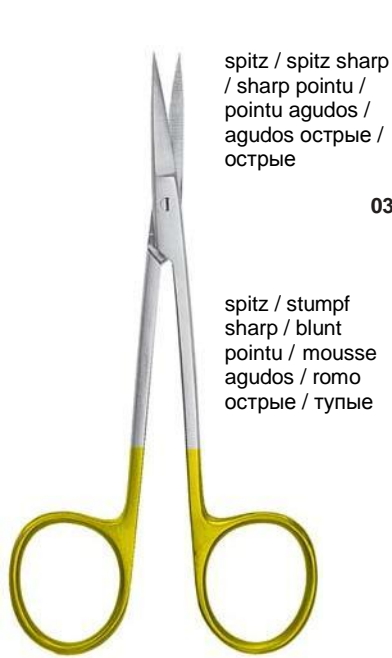

IRIS
 11,5 cm, 4½"

spitz / spitz sharp
 / sharp pointu /
 pointu agudos /
 agudos острые /
 острые



spitz / stumpf
 sharp / blunt
 pointu / mousse
 agudos / romo
 острые / тупые



UNIVERSAL
 12,0 cm, 4¾"
 03-12-800-12

gezahnt
 serrated
 dentelée
 dentada
 зазубренные



LISTER
 18,0 cm, 7" 03-12-900-18
 20,0 cm, 8" 03-12-900-20

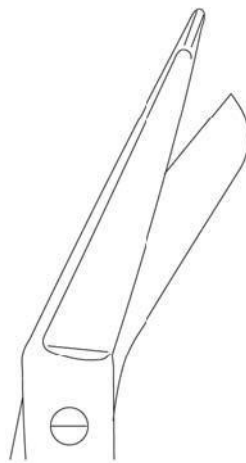

BRUNS
 24,0 cm, 9½"
 03-12-909-24

gezahnt
 serrated
 dentelée
 dentada
 зазубренные

Super-Cut Scheren
 Super-Cut Scissors
 Ciseaux SUPERCUT
 Tijeras Super-Cut
 Супер-острые ножницы

3



14,5 cm, 5³/₄" 03-13-100-14 03-13-101-14
 17,0 cm, 6³/₄" 03-13-100-17 03-13-101-17
 23,0 cm, 9" 03-13-100-23 03-13-101-23

MAYO



14,5 cm, 5³/₄" 03-13-111-14
 18,0 cm, 7" 03-13-111-18
 20,0 cm, 8" 03-13-111-20
 23,0 cm, 9" 03-13-111-23
 25,0 cm, 10" 03-13-111-25
 28,0 cm, 11" 03-13-111-28
 30,0 cm, 12" 03-13-111-30

METZENBAUM



14,5 cm, 5³/₄" 03-13-121-14
 18,0 cm, 7" 03-13-121-18
 20,0 cm, 8" 03-13-121-20
 23,0 cm, 9" 03-13-121-23
 25,0 cm, 10" 03-13-121-25
 28,0 cm, 11" 03-13-121-28
 30,0 cm, 12" 03-13-121-30

METZENBAUM-FINO



15,0 cm, 6" 03-13-129-15
 19,0 cm, 7¹/₂" 03-13-129-19

KAYE FACE LIFT



JABALEY
 12,0 cm, 4¾"
 03-13-130-12



ENDARTERECTOMY
 18,0 cm, 7"
 03-13-133-18



TOENNIS-ADSON
 17,5 cm, 6¾"
 03-13-139-17



STRABISMUS
 11,5 cm, 4½"

03-13-240-11



03-13-241-11



JAMISON

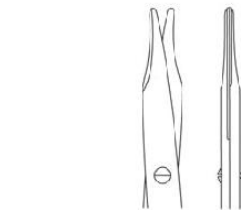

14,0 cm, 5½" 03-13-218-14
 18,0 cm, 7" 03-13-218-18



14,0 cm, 5½" 03-13-219-14
 18,0 cm, 7" 03-13-219-18

Super-Cut Scheren
 Super-Cut Scissors
 Ciseaux SUPERCUT
 Tijeras Super-Cut
 Супер-острые ножницы

3



REYNOLDS
 15,0 cm, 5" 03-13-210-15
 18,0 cm, 7" 03-13-210-18



BABY-METZENBAUM
 12,0 cm, 4 3/4"

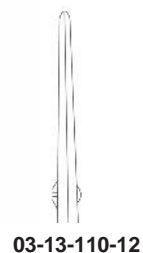

03-13-110-12



03-13-111-12



IRIS
 9,5 cm, 3 3/4" 03-13-244-09
 11,5 cm, 4 1/2" 03-13-244-11



IRIS
 9,5 cm, 3 3/4" 03-13-245-09
 11,5 cm, 4 1/2" 03-13-245-11



STEVENS TENOTOMY
 10,5 cm, 4 1/8" 03-13-290-10
 11,5 cm, 4 1/2" 03-13-290-11



STEVENS TENOTOMY
 10,5 cm, 4 1/8" 03-13-291-10
 11,5 cm, 4 1/2" 03-13-291-11



KILNER
 12,5 cm, 4¾"
 03-13-200-12



KILNER
 12,5 cm, 4¾"
 03-13-201-12



HEGELMANN
 19,0 cm, 7½"



03-13-551-25

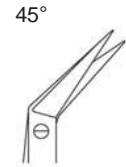

03-13-551-45



03-13-551-60

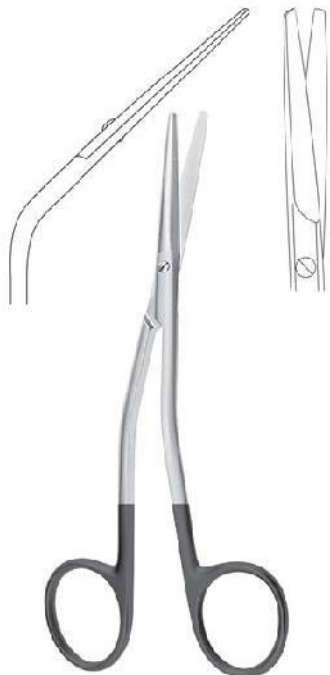

FOMON
 14,0 cm, 5½"
 03-13-343-14



COTTLE
 16,5 cm, 6¼"
 03-13-511-16

Mikro-Scheren
Micro Scissors
Micro-Ciseaux
Micro-Tijeras
Микро-ножницы

3

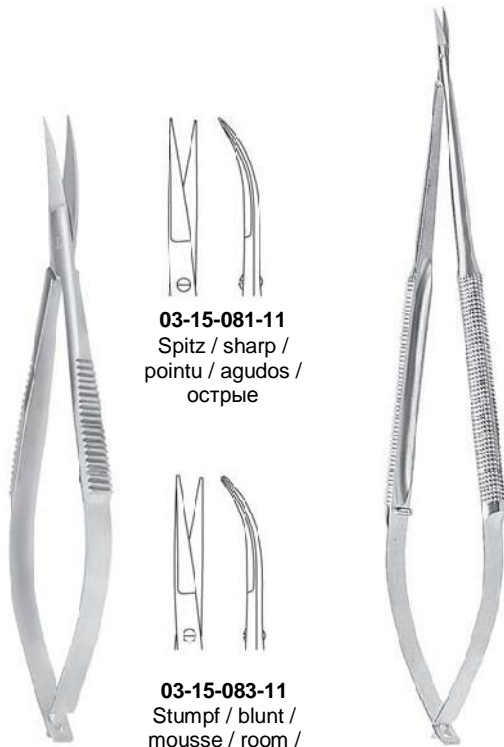

WESTCOT
11,0 cm, 4 $\frac{3}{8}$ "

03-15-081-11
Spitz / sharp /
pointu / agudos /
острые

03-15-083-11
Stumpf / blunt /
mousse / room /
тупые

GOMEL

14 mm

9 mm



Gezahnt / serrated / dentelée / dentada / зазубренные

15,0 cm, 6" **03-15-240-15Z** **03-15-241-15Z** **03-15-242-15Z** **03-15-243-15Z**
 18,0 cm, 7" **03-15-240-18Z** **03-15-241-18Z** **03-15-243-18Z** **03-15-241-18Z**

14 mm

9 mm



Glatt / smath / lisses / lisas / гладкие

15,0 cm, 6" **03-15-240-15** **03-15-241-15** **03-15-242-15** **03-15-243-15**
 18,0 cm, 7" **03-15-240-18** **03-15-241-18** **03-15-243-18** **03-15-241-18**



HEPP SCHEIDEL

Mikro-Präparierscheren
 Micro, dissecting scissors
 Micro-Ciseaux a dissection
 Micro-tijeras de disección
 Микро-анатомические ножницы



Gezahnt / serrated / dentelée / dentada / зазубренные

15,0 cm, 6" **315-244-15Z** **315-245-15Z**
 18,0 cm, 7" **315-244-18Z** **315-245-18Z**



Glatt / smath / lisses / lisas / гладкие

15,0 cm, 6" **03-15-244-15** **03-15-245-15**
 18,0 cm, 7" **03-15-244-18** **03-15-245-18**



18,0 cm, 7"



03-15-246-01



03-15-246-02



03-15-246-03



18,0 cm, 7"

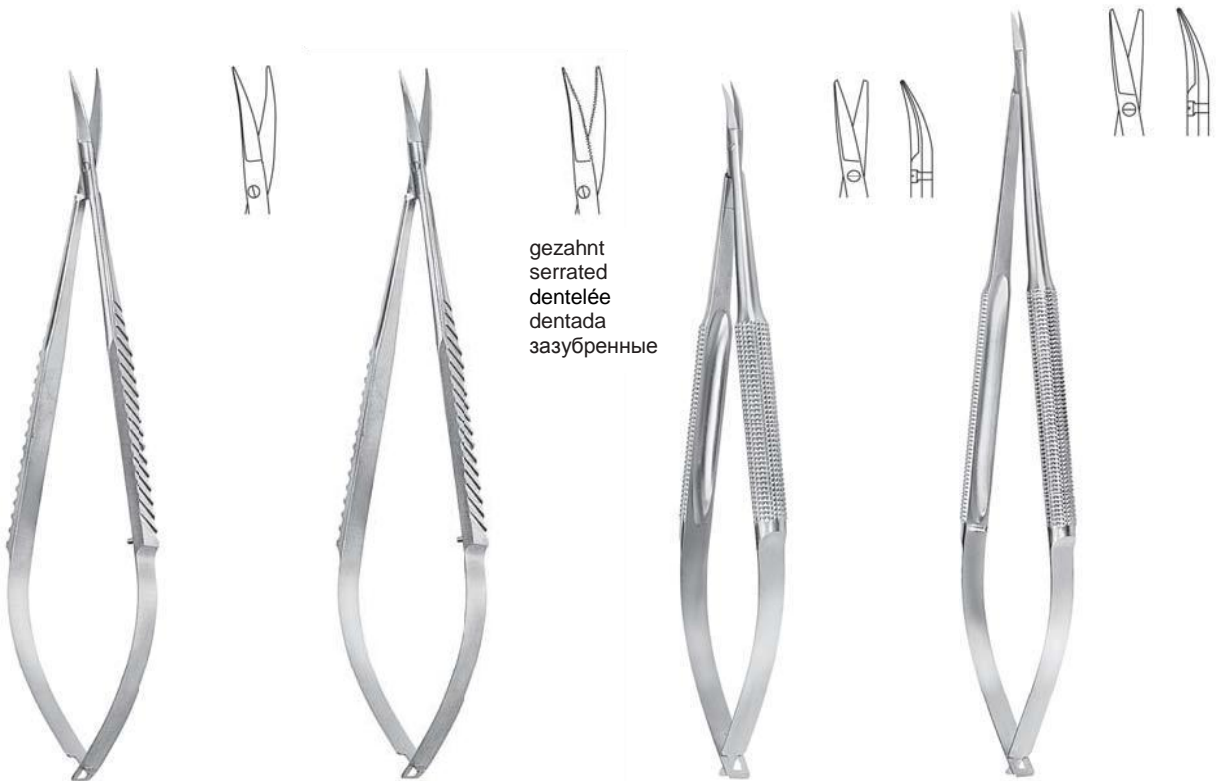
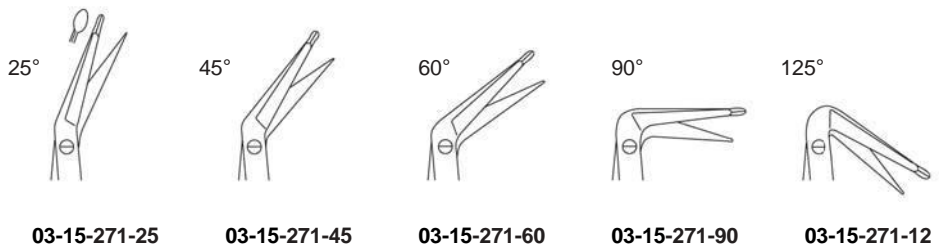
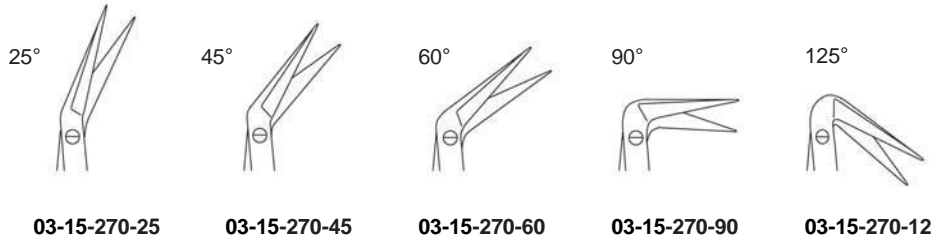

15,0 cm, 6"
03-15-223-15

15,0 cm, 6"
03-15-223-15Z

15,0 cm, 6"
03-15-201-15

18,0 cm, 7"
03-15-201-18

Mikro-Adventitiascheren
Micro Adventitia Scissors
Micro-Ciseaux Adventitia
Micro-Tijeras Adventitia
Микро-ножницы для соединительной ткани

3



15,0 cm, 6"
03-15-232-15



15,0 cm, 6"
03-15-232-15Z



gezahnt
serrated
dentelée
dentada
зазубренные



15,0 cm, 6"
03-15-203-15

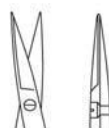

18,0 cm, 7"
03-15-203-18



STEVENS



18,5 cm, 7¹/₄" **03-15-290-01** **03-15-290-02** **03-15-290-03** **03-15-290-04**
22,0 cm, 8⁵/₈" **03-15-291-01** **03-15-291-02** **03-15-291-03** **03-15-291-04**



18,5 cm, 7¹/₄" **03-15-292-01** **03-15-292-02**
22,5 cm, 8³/₄" **03-15-293-01** **03-15-293-02**



LITTLER

Super-Cut

| | | |
|----------------------------|---------------|---------------|
| 11,8 cm, 4 $\frac{3}{4}$ " | 03-11-0253-11 | 03-13-0253-11 |
| 14,0 cm, 5 $\frac{1}{2}$ " | 03-11-0253-14 | 03-13-0253-14 |
| 18,0 cm, 7" | 03-11-0253-18 | |



MAYO-HARRINGTON

23,0 cm



03-11-108-23



03-11-109-23



MILLS

22,5 cm
03-11-455-21

Feine chirurgische Scheren
 Fine surgical scissors
 Fins ciseaux chirurgicaux
 Tijeras finas para cirugía
 Тонкие хирургические ножницы

3



WILMER
 10,0 cm
 03-11-0255-10



gezahnt
 serrated
 dentelée
 dentada
 зазубренные

03-11-0257-11

03-11-0258-11



LA GRANGE
 11,5 cm



RIBBON
 9,5 cm
 03-11-268-01

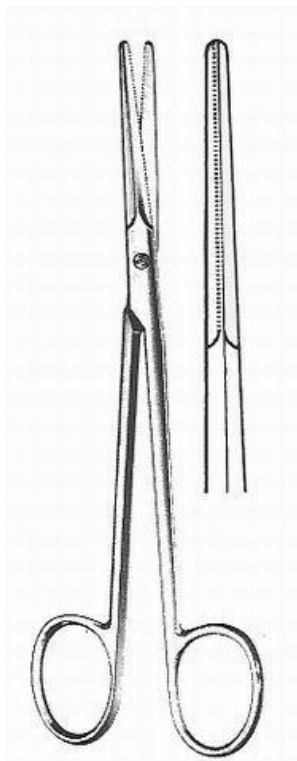

BEUSE
 14,0 cm 03-11-330-14
 18,0 cm 03-11-330-18

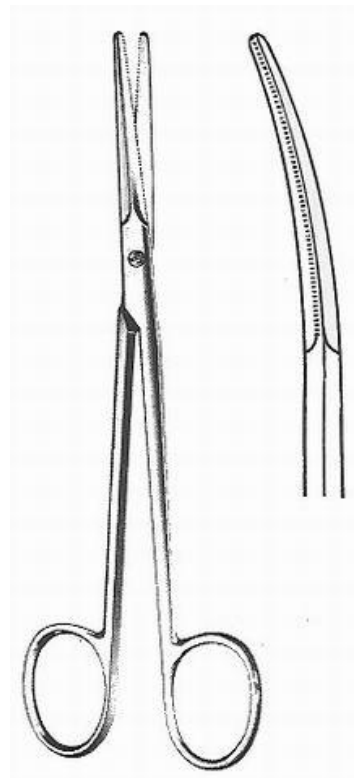

BEUSE
 14,0 cm 03-11-331-14
 18,0 cm 03-11-331-18



Locklin
16,0 cm
03-11-532-16



Locklin
16,0 cm
03-11-534-16
TC 03-12-534-16
SC 03-13-534-16



Locklin
16,0 cm
03-11-535-16
TC 03-12-535-16
SC 03-13-535-16



FAVALORO
16,0 cm 03-11-563-16

**Pinzetten
Forceps
Pincers
Pinzas
Пинцеты**





STANDARD
 10,5 cm, 4 $\frac{1}{8}$ " **05-16-002-10**
 11,5 cm, 4 $\frac{1}{2}$ " **05-16-002-11**
 13,0 cm, 5" **05-16-002-13**
 14,5 cm, 5 $\frac{3}{4}$ " **05-16-002-14**
 16,0 cm, 6 $\frac{1}{4}$ " **05-16-002-16**
 18,0 cm, 7" **05-16-002-18**
 20,0 cm, 8" **05-16-002-20**
 25,0 cm, 10" **05-16-002-25**
 30,0 cm, 12" **05-16-002-30**



schmal
 narrow
 étroite
 estrechos
 узкие

STANDARD
 10,5 cm, 4 $\frac{1}{8}$ " **05-16-003-10**
 11,5 cm, 4 $\frac{1}{2}$ " **05-16-003-11**
 13,0 cm, 5" **05-16-003-13**
 14,5 cm, 5 $\frac{3}{4}$ " **05-16-003-14**
 16,0 cm, 6 $\frac{1}{4}$ " **05-16-003-16**
 18,0 cm, 7" **05-16-003-18**
 20,0 cm, 8" **05-16-003-20**
 25,0 cm, 10" **05-16-003-25**
 30,0 cm, 12" **05-16-003-30**



schmal
 narrow
 étroite
 estrechos
 узкие

STANDARD
 10,5 cm, 4 $\frac{1}{8}$ " **05-16-004-10**
 11,5 cm, 4 $\frac{1}{2}$ " **05-16-004-11**
 13,0 cm, 5" **05-16-004-13**
 14,5 cm, 5 $\frac{3}{4}$ " **05-16-004-14**
 16,0 cm, 6 $\frac{1}{4}$ " **05-16-004-16**
 18,0 cm, 7" **05-16-004-18**
 20,0 cm, 8" **05-16-004-20**
 25,0 cm, 10" **05-16-004-25**
 30,0 cm, 12" **05-16-004-30**



fein
 fine
 fin
 finas
 тонкие

STANDARD
 10,5 cm, 4 $\frac{1}{8}$ " **05-16-010-10**
 11,5 cm, 4 $\frac{1}{2}$ " **05-16-010-11**
 13,0 cm, 5" **05-16-010-13**
 14,5 cm, 5 $\frac{3}{4}$ " **05-16-010-14**
 16,0 cm, 6 $\frac{1}{4}$ " **05-16-010-16**
 18,0 cm, 7" **05-16-010-18**
 20,0 cm, 8" **05-16-010-20**
 25,0 cm, 10" **05-16-010-25**



fein
 fine
 fin
 finas
 тонкие



schmal
 narrow
 étroite
 estrechos
 узкие



10,5 cm, 4¹/₈" **05-16-011-10**
 11,5 cm, 4¹/₂" **05-16-011-11**
 13,0 cm, 5" **05-16-011-13**
 14,5 cm, 5³/₄" **05-16-011-14**
 16,0 cm, 6" **05-16-011-16**
 18,0 cm, 7" **05-16-011-18**
 20,0 cm, 8" **05-16-020-20**
 25,5 cm, 10" **05-16-025-25**
 30,0 cm, 12" **05-16-030-30**

MOD. USA

12,0 cm, 4³/₄" **05-16-006-12**
 13,0 cm, 5" **05-16-006-13**
 14,5 cm, 5³/₄" **05-16-006-14**
 15,0 cm, 6" **05-16-006-15**
 18,0 cm, 7" **05-16-006-18**
 20,0 cm, 8" **05-16-006-20**
 25,5 cm, 10" **05-16-006-25**
 30,0 cm, 12" **05-16-006-30**

MOD. USA

12,0 cm, 4³/₄" **05-16-012-11**
 13,0 cm, 5" **05-16-012-13**
 14,5 cm, 5³/₄" **05-16-012-14**
 15,0 cm, 6" **05-16-012-15**

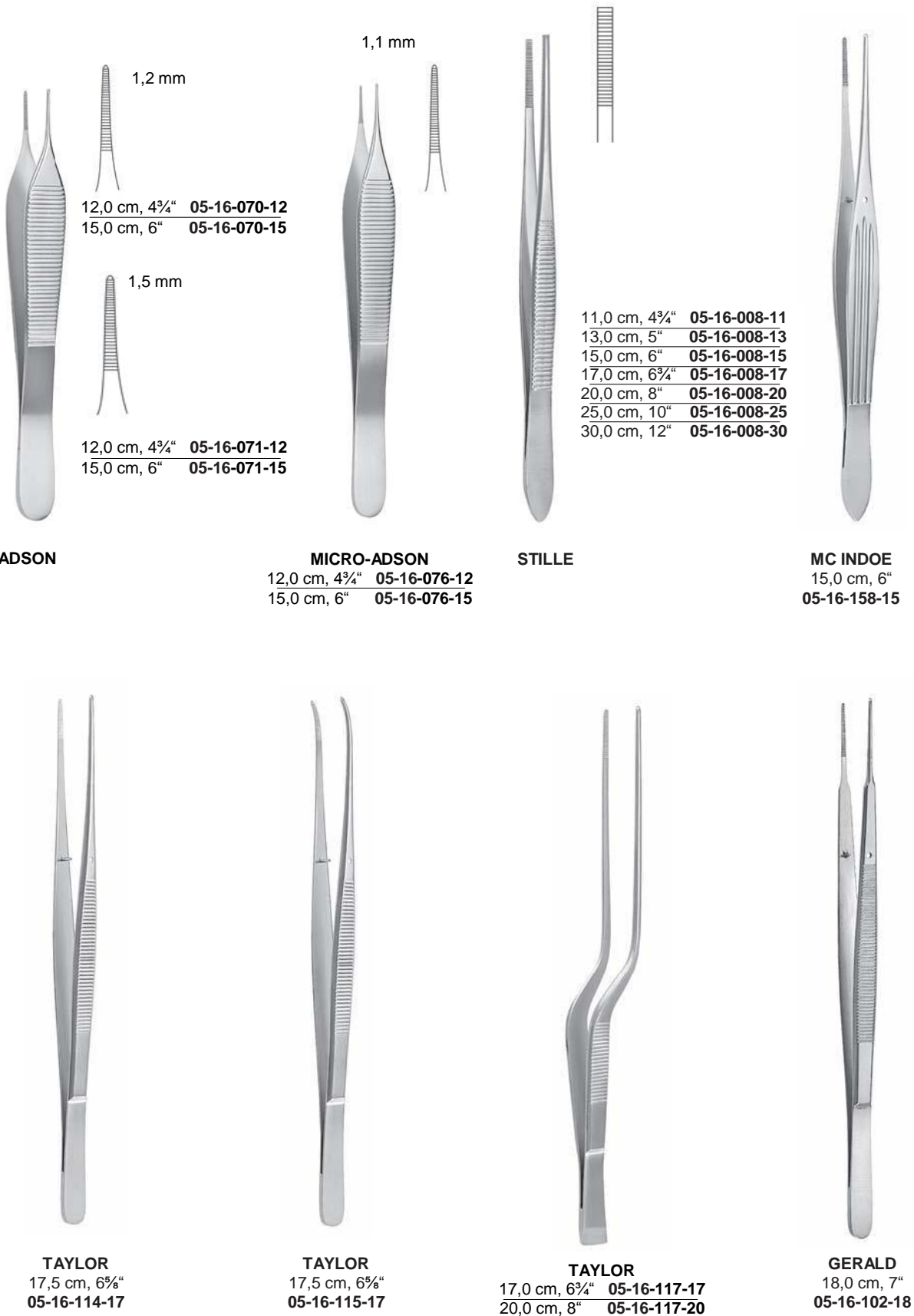



GERALD
 18,0 cm, 7"
05-16-103-18



POTTS-SMITH
 18,0 cm, 7" **05-16-026-18**
 21,0 cm, 8¼" **05-16-026-21**
 23,0 cm, 9" **05-16-026-23**
 25,0 cm, 10" **05-16-026-25**
 30,0 cm, 12" **05-16-026-30**



POTTS-SMITH
 18,0 cm, 7" **05-16-027-18**
 21,0 cm, 8¼" **05-16-027-21**
 25,0 cm, 10" **05-16-027-25**
 30,0 cm, 12" **05-16-027-30**



13,0 cm, 5" **05-16-036-13**
 14,5 cm, 5¾" **05-16-036-14**
 15,0 cm, 6" **05-16-036-15**

englische Modelle
 english patterns
 modèle anglais
 modelos ingleses
 английская модель



SEMKEN

12,5 cm, 4¾" **05-16-040-12**
 15,0 cm, 6" **05-16-040-15**

12,5 cm, 4¾" **05-16-041-12**
 15,0 cm, 6" **05-16-041-15**



CUSHING
 17,5 cm, 6⅞" **05-16-092-17**
 20,0 cm, 8" **05-16-092-20**



CUSHING
 17,5 cm, 6⅞" **05-16-093-17**

Anatomische Pinzetten
 Dissecting Forceps
 Pinces a dissection
 Pinzas de disección
 Пинцеты анатомические



BROPHY
 20,0 cm, 8"
 05-16-094-20



BROPHY
 20,0 cm, 8"
 05-16-095-20



BONNEY
 18,0 cm, 7"
 05-16-120-18



SINGLE-TUTTLE
 18,0 cm, 7" 05-16-120-18
 23,0 cm, 9" 05-16-120-23



DUEHRSEN
 20,0 cm, 8"
 05-16-470-20



WAUGH
 15,0 cm, 6" 05-16-130-15
 18,0 cm, 7" 05-16-130-18
 20,0 cm, 8" 05-16-130-20



RAMSEY
 18,0 cm, 7"
 05-16-136-18

1 x 2



2 x 3



3 x 4



3 x 4

4 x 5



STANDARD

10,5 cm, 4¹/₈" 05-16-200-10
 11,5 cm, 4¹/₂" 05-16-200-11
 13,0 cm, 5" 05-16-200-13
 14,5 cm, 5³/₄" 05-16-200-14
 16,0 cm, 6¹/₄" 05-16-200-16
 18,0 cm, 7" 05-16-200-18
 20,0 cm, 8" 05-16-200-20
 25,0 cm, 10" 05-16-200-25
 30,0 cm, 12" 05-16-200-30

11,5 cm, 4¹/₂" 05-16-252-11
 13,0 cm, 5" 05-16-252-13
 14,5 cm, 5³/₄" 05-16-252-14
 16,0 cm, 6¹/₄" 05-16-252-16
 18,0 cm, 7" 05-16-252-18
 20,0 cm, 8" 05-16-252-20
 25,0 cm, 10" 05-16-252-25
 30,0 cm, 12" 05-16-252-30

13,0 cm, 5" 05-16-254-13
 14,5 cm, 5³/₄" 05-16-254-14
 16,0 cm, 6¹/₄" 05-16-254-16
 18,0 cm, 7" 05-16-254-18
 20,0 cm, 8" 05-16-254-20

13,0 cm, 5" 05-16-256-13
 14,5 cm, 5³/₄" 05-16-256-14
 16,0 cm, 6¹/₄" 05-16-256-16

Chirurgische Pinzetten
Tissue Forceps Pincers a
dissection a griffes
Pinzas quirúrgicas
Пинцеты хирургические

5

 1 x 2



fein
fine
fin
finas
тонкие

11,5 cm, 4½" **05-16-210-11**
13,0 cm, 5" **05-16-210-13**
14,5 cm, 5¾" **05-16-210-14**
16,0 cm, 6¼" **05-16-210-16**
18,0 cm, 7" **05-16-210-18**
20,0 cm, 8" **05-16-210-20**

 1 x 2



mit Stift
with pin
avec goupille
con perno
со штифтом

16,0 cm, 6¼"
05-16-218-16

 1 x 2



mit Stift
with pin
avec goupille
con perno
со штифтом

10,5 cm, 4¼"
05-16-219-10

 1 x 2



MOD. USA

| | |
|--------------|---------------------|
| 12,0 cm, 4¾" | 05-16-206-12 |
| 13,0 cm, 5" | 05-16-206-13 |
| 14,5 cm, 5¾" | 05-16-206-14 |
| 15,5 cm, 6" | 05-16-206-15 |
| 18,0 cm, 7" | 05-16-206-18 |
| 20,0 cm, 8" | 05-16-206-20 |
| 25,0 cm, 10" | 05-16-206-25 |
| 30,0 cm, 12" | 05-16-206-30 |

 2 x 3



MOD. USA

| | |
|--------------|---------------------|
| 12,0 cm, 4¾" | 05-16-212-12 |
| 13,0 cm, 5" | 05-16-212-13 |
| 14,5 cm, 5¾" | 05-16-212-14 |
| 15,5 cm, 6" | 05-16-212-15 |
| 18,0 cm, 7" | 05-16-212-18 |
| 20,0 cm, 8" | 05-16-212-20 |
| 25,0 cm, 10" | 05-16-212-25 |
| 30,0 cm, 12" | 05-16-212-30 |

 1 x 2



ADSON

1,2 mm



12,0 cm, 4¾" **05-16-271-12**
15,0 cm, 6" **05-16-271-15**

1,5 mm



12,0 cm, 4¾" **05-16-270-12**
15,0 cm, 6" **05-16-270-15**

1 x 2



MICRO-ADSON

| | |
|--------------|---------------------|
| 12,0 cm, 4¾" | 05-16-276-12 |
| 15,0 cm, 6" | 05-16-276-15 |



Chirurgische Pinzetten
Tissue Forceps Pincers a
dissection a griffes
Pinzas quirúrgicas
Пинцеты хирургические

5



ADSON
12,0 cm, 4¾"
05-16-282-12



ADSON
12,0 cm, 4¾" 05-16-274-12
15,0 cm, 6" 05-16-274-15



ADSON-BROWN
12,0 cm, 4¾" 05-16-288-12
15,0 cm, 6" 05-16-288-15



GILLIES
15,0 cm, 6"
05-16-300-15



STILLE
15,0 cm, 6"
05-16-208-15



STILLE
15,0 cm, 6"
05-16-209-15



ADLERKREUTZ
13,0 cm, 5" 05-16-382-13
15,0 cm, 6" 05-16-382-15
18,0 cm, 7" 05-16-382-18
20,0 cm, 8" 05-16-382-20
25,0 cm, 10" 05-16-382-25



ADLERKREUTZ
13,0 cm, 5" 05-16-384-13
15,0 cm, 6" 05-16-384-15
18,0 cm, 7" 05-16-384-18
20,0 cm, 8" 05-16-384-20
25,0 cm, 10" 05-16-384-25



SEMKEN



SEMKEN
 12,5 cm, 5"
05-16-242-12



GERALD
 18,0 cm, 7"
05-16-302-18



GERALD
 18,0 cm, 7"
05-16-303-18



TAYLOR
 17,5 cm, 6 5/8"
05-16-314-17



TAYLOR
 17,5 cm, 6 5/8"
05-16-315-17



TAYLOR
 17,5 cm, 6 5/8"
05-16-317-17



MC INDOE
 15,0 cm, 6"
05-16-358-15

1 x 2



CUSHING
 17,5 cm, 6⁵/₈"
 05-16-292-17

1 x 2



CUSHING
 17,5 cm, 6⁵/₈"
 05-16-293-17

1 x 2



POTTS-SMITH
 18,0 cm, 7" 05-16-226-18
 21,0 cm, 8¹/₄" 05-16-226-21
 25,0 cm, 10" 05-16-226-25
 30,0 cm, 12" 05-16-226-30

1 x 2



POTTS-SMITH
 18,0 cm, 7" 05-16-227-18
 21,0 cm, 8¹/₄" 05-16-227-21
 25,0 cm, 10" 05-16-227-25
 30,0 cm, 12" 05-16-227-30

1 x 2



WAUGH
 15,0 cm, 6" 05-16-330-15
 18,0 cm, 7" 05-16-330-18
 20,0 cm, 8" 05-16-330-20
 25,0 cm, 10" 05-16-330-25
 30,5 cm, 12¹/₂" 05-16-330-30

1 x 2



BROPHY
 20,0 cm, 8"
 05-16-294-20

1 x 2



BROPHY
 20,0 cm, 8"
 05-16-295-20



RUSS. MODELL
 15,0 cm, 6" 05-16-456-15
 20,0 cm, 8" 05-16-456-20
 25,0 cm, 10" 05-16-456-25
 30,0 cm, 12" 05-16-456-30



DURANTE
 14,5 cm, 5¾" **05-16-460-14**
 16,0 cm, 6¼" **05-16-460-16**
 20,0 cm, 8" **05-16-460-20**



DUEHRSEN
 20,0 cm, 8"

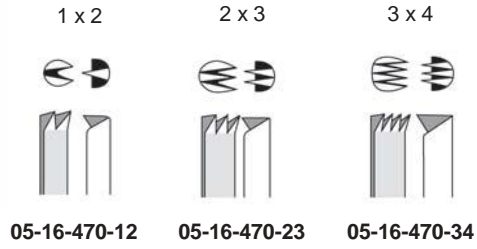

NELSON
 23,0 cm, 9"
05-16-518-23



DUVAL
 14,0 cm, 5½"
05-16-586-14



COLLIN-DUVAL
 20,0 cm, 8"



Fig. 1
05-16-494-01

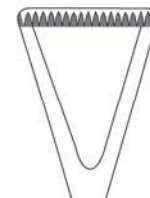

Fig. 2
05-16-494-02

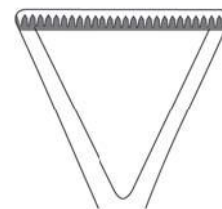

Fig. 3
05-16-494-03



Chirurgische Pinzetten
Tissue Forceps
Pinces a dissection a griffes
Pinzas quirúrgicas
Пинцеты хирургические

5



1 x 2

LANE
14,5 cm, 5³/₄" 05-16-420-14
18,0 cm, 7" 05-16-420-18
20,0 cm, 8" 05-16-420-20



2 x 3

LANE
14,5 cm, 5³/₄" 05-16-422-14
20,0 cm, 8" 05-16-422-20



7 x 7

BROWN
12,0 cm, 4³/₄" 05-16-410-12
16,0 cm, 6¹/₄" 05-16-410-16
20,0 cm, 8" 05-16-410-20
25,0 cm, 10" 05-16-410-25



1 x 2

TREVES
13,0 cm, 5" 05-16-510-13
15,0 cm, 6" 05-16-510-15
18,0 cm, 7" 05-16-510-18



1 x 2

FERRIS SMITH
18,0 cm, 7"
05-16-520-18



2 x 3

FERRIS SMITH
18,0 cm, 7"
05-16-522-18



1 x 2

BONNEY
18,0 cm, 7"
05-16-590-18



2 x 3

BONNEY
18,0 cm, 7"
05-16-592-18



8,0 cm, 3¼" **05-16-662-08**
9,0 cm, 3½" **05-16-662-09**
10,5 cm, 4⅞" **05-16-662-10**
11,5 cm, 4½" **05-16-662-11**
13,0 cm, 5" **05-16-662-13**
14,5 cm, 5½" **05-16-662-14**

8,0 cm, 3¼" **05-16-663-08**
9,0 cm, 3½" **05-16-663-09**
10,5 cm, 4⅞" **05-16-663-10**
11,5 cm, 4½" **05-16-663-11**
13,0 cm, 5" **05-16-063-13**
14,5 cm, 5½" **05-16-663-14**

8,0 cm, 3¼" **05-16-666-08**
9,0 cm, 3½" **05-16-666-09**
10,5 cm, 4⅞" **05-16-666-10**
11,5 cm, 4½" **05-16-666-11**
13,0 cm, 5" **05-16-666-13**
14,5 cm, 5½" **05-16-666-14**

8,0 cm, 3¼" **05-16-667-08**
9,0 cm, 3½" **05-16-667-09**
10,5 cm, 4⅞" **05-16-667-10**
11,5 cm, 4½" **05-16-667-11**
13,0 cm, 5" **05-16-667-13**
14,5 cm, 5½" **05-16-667-14**



Splitterpinzetten, Mikro-Pinzetten
Splinter Forceps, Micro Forceps
Pinces a échardes, Pinces micro
Pinzas para espinas, Pinzas para microscopia
Пинцеты для извлечения заноз, микро-пинцеты

5



HUNTER
10,5 cm, 4¼"
05-16-652-10



HUNTER
10,5 cm, 4¼"
05-16-653-10



WALTER-CARMALT
10,5 cm, 4¼"
05-16-656-10



WALTER-CARMALT
10,5 cm, 4¼"
05-16-657-10



FEILCHENFELD
7,5 cm, 3¼" 05-16-650-07
9,0 cm, 3½" 05-16-650-09
11,5 cm, 4½" 05-16-650-11



10,0 cm, 4"
05-16-806-10



10,0 cm, 4"
05-16-807-10



05-16-809-16

05-16-810-16

16,0 cm, 6¼"



GRAEFE
 10,0 cm, 4" **05-16-810-10**
 13,0 cm, 5" **05-16-810-13**
 14,0 cm, 5½" **05-16-810-14**



GRAEFE
 10,0 cm, 4" **05-16-811-10**
 13,0 cm, 5" **05-16-811-13**
 14,0 cm, 5½" **05-16-811-14**



GRAEFE
 10,0 cm, 4" **05-16-813-10**
 13,0 cm, 5" **05-16-813-13**
 14,0 cm, 5½" **05-16-813-14**



GRAEFE
 10,0 cm, 4" **05-16-814-10**
 13,0 cm, 5" **05-16-814-13**
 14,0 cm, 5½" **05-16-814-14**



GRAEFE
 10,0 cm, 4" **05-16-815-10**
 13,0 cm, 5" **05-16-815-13**
 14,0 cm, 5½" **05-16-815-14**



GRAEFE
 10,0 cm, 4" **05-16-817-10**
 13,0 cm, 5" **05-16-817-13**
 14,0 cm, 5½" **05-16-817-14**



Fig. 3
 12,0 cm, 4³/₄"
 05-16-601-03



Fig. 4
 11,5 cm, 4¹/₂"
 05-16-601-04



Fig. 5
 11,5 cm, 4¹/₂"
 05-16-601-05



Fig. 7
 11,5 cm, 4¹/₂"
 05-16-601-07



0,3 mm x 45°

11,0 cm, 4³/₈"
 05-16-620-01



0,3 mm x 90°

11,0 cm, 4³/₈"
 05-16-620-02



0,3 mm x 0°

11,0 cm, 4³/₈"
 05-16-620-03



0,3 mm x 45°

11,0 cm, 4³/₈"
 05-16-620-04

diamantbeschichtet
 diamond coated
 diamant pelliculée
 diamantado
 с алмазным
 покрытием

Pinzetten mit Hartmetalleinlagen
Forceps with tungsten carbide inserts
Pinzas a mors TC
Пинцеты с твердосплавной вставкой



DE BAKEY

1,5 mm 2,0 mm 2,4 mm 2,8 mm



| | | | | |
|--------------|---------------------|---------------------|---------------------|---------------------|
| 16,0 cm, 6¼" | 05-16-700-16 | 05-16-702-16 | 05-16-704-16 | 05-16-706-16 |
| 20,0 cm, 8" | 05-16-700-20 | 05-16-702-20 | 05-16-704-20 | 05-16-706-20 |
| 24,0 cm, 9½" | 05-16-700-24 | 05-16-702-24 | 05-16-704-24 | 05-16-706-24 |
| 30,0 cm, 12" | 05-16-700-30 | 05-16-702-30 | 05-16-704-30 | 05-16-706-30 |
| 35,0 cm, 14" | - | 05-16-702-35 | - | 05-16-706-35 |

3,5 mm



| | |
|--------------|---------------------|
| 16,0 cm, 6¼" | 05-16-708-16 |
| 20,0 cm, 8" | 05-16-708-20 |
| 24,0 cm, 9½" | 05-16-708-24 |
| 30,0 cm, 12" | 05-16-708-30 |
| 35,0 cm, 14" | 05-16-708-35 |



DE BAKEY

1,5 mm 2,0 mm



| | | |
|--------------|---------------------|---------------------|
| 16,0 cm, 6¼" | 05-16-701-16 | 05-16-703-16 |
| 20,0 cm, 8" | - | 05-16-703-20 |
| 24,0 cm, 9½" | - | 05-16-703-24 |
| 30,0 cm, 12" | - | 05-16-703-30 |

Atraumatische Pinzetten
 Atraumatic Forceps
 Pinces atraumatiques
 Pinzas atraumáticas
 Пинцеты атравматические



5



STANDARD
 13,0 cm, 5" **05-17-200-13**
 14,5 cm, 5¾" **05-17-200-14**
 16,0 cm, 6¼" **05-17-200-16**
 18,0 cm, 7" **05-17-200-18**
 20,0 cm, 8" **05-17-200-20**
 25,0 cm, 10" **05-17-200-25**



STANDARD
 14,0 cm, 5½" **05-17-218-14**
 16,0 cm, 6¾" **05-17-218-16**
 18,0 cm, 7" **05-17-218-18**
 20,0 cm, 8" **05-17-218-20**



WANGENSTEIN
 15,0 cm, 6" **05-17-140-15**
 23,0 cm, 9" **05-17-140-23**
 25,0 cm, 10" **05-17-140-25**

Pinzette mit Hartmetalleinlagen
 Forceps with tungsten carbide inserts
 Pinças a mors TC
 Pinzas con bocas de carburo tungsteno
 Пинцеты с твердосплавной вставкой



GILLIES
 15,0 cm, 6"
 05-17-300-15



MC INDOE
 15,0 cm, 6"
 05-17-158-15



05-17-102-17

1 x 2

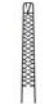

05-17-302-17



POTTS-SMITH
 15,0 cm, 6" 05-17-026-15
 18,0 cm, 7" 05-17-026-18
 20,0 cm, 8" 05-17-026-20
 25,0 cm, 10" 05-17-026-25



BONNEY
 17,5 cm, 6 7/8"
 05-17-590-17



05-17-092-17



05-17-093-17

CUSHING
 17,5 cm, 6 7/8"



CUSHING-TAYLOR
 18,0 cm, 7" 05-17-117-18
 20,0 cm, 8" 05-17-117-20



12,0 cm, 4 3/4"
 05-17-070-12

1 x 2



12,0 cm, 4 3/4"
 05-17-071-12



15,0 cm, 6"
 05-17-070-15

1 x 2



15,0 cm, 6"
 05-17-071-15

ADSON

**Tuch-, Schlauchklemmen, Tupferzangen
Towel Clamps, Sponge and Dressing Forceps,
Tubing Clamps
Pincés a pansement et a éponges, Pincés a
champs, pincés presse-tubes
Pinzas de campo, Pinzas para vendajes
y torundas y para tubos
Зажимы для операционного белья,
для тампонов, для трубок**





SCHAEDEL
9,0 cm, 3½"
07-22-101-09



ENGL. MODELL
9,0 cm, 3½"
07-22-109-09



JONES
5,5 cm, 2" 07-22-105-05
9,0 cm, 3½" 07-22-105-09



JONES
9,0 cm, 3½"
07-22-107-09

mit Schlauch- oder Kabelhalter
with clip for tubing or cable
avec clamp porte-tube
con porta-tubo o porta-cable
с зажимом для кабеля и трубки



BACKHAUS
9,0 cm, 3½" 07-22-000-09
11,0 cm, 4¾" 07-22-000-11
13,0 cm, 5" 07-22-000-13
15,0 cm, 6" 07-22-000-15



11,0 cm, 4¾" 07-22-005-11
13,0 cm, 5" 07-22-005-13
15,0 cm, 6" 07-22-005-15



ROEDER
13,0 cm, 5" 07-22-010-13
15,0 cm, 6" 07-22-010-15



BERNHARD
 16,5 cm, 6½"
07-22-044-16



9,5 cm, 4" 07-22-024-10
11,0 cm, 4¾" 07-22-024-11
13,0 cm, 5" 07-22-024-13
14,0 cm, 5½" 07-22-024-14
15,5 cm, 6¼" 07-22-024-16

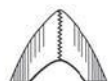

LORNA
9,0 cm, 3½" 07-22-014-09
11,0 cm, 4¾" 07-22-014-11
13,0 cm, 5" 07-22-014-13



LANE
13,0 cm, 5" 07-22-040-13
15,0 cm, 6" 07-22-040-15
20,0 cm, 8" 07-22-040-20

Tuchklemmen, Korn- und Tupferzangen
 Towel Clamps, Sponge and Dressing Forceps
 Pincas a champs, Pincas a pansement et a éponges
 Pinzas de campo, Pinzas para vendajes y torundas
 Зажимы для операционного белья, зажимы для тампона



THOKU



PEERS
 14,5 cm, 5 3/4"
 07-22-030-14



LISTER
 13,0 cm, 5" 07-22-360-13
 16,0 cm, 6 1/4" 07-22-360-16
 18,0 cm, 7" 07-22-360-18



BRYANT
 13,0 cm, 5"
 07-22-351-13



BOZEMANN
 26,0 cm, 10 1/4"
 07-22-320-26



BOZEMANN
 26,0 cm, 10¹/₄"
 07-22-321-26



COLLIN
 25,0 cm, 9³/₄"
 07-22-300-25



CHERON
 25,0 cm, 9³/₄"
 07-22-303-25

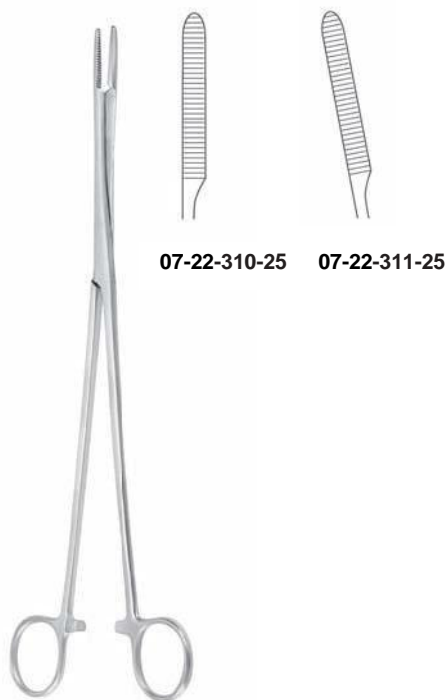

PERLMANN
 25,0 cm, 9³/₄"



ULRICH

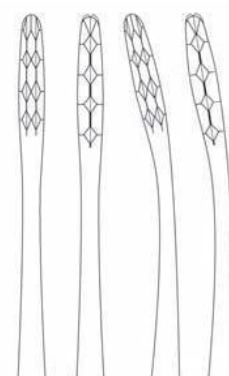

| | | |
|---|---------------------|---------------------|
| 18,0 cm, 7" | 07-22-200-18 | 07-22-201-18 |
| 22,0 cm, 8 ⁵ / ₆ " | 07-22-200-22 | 07-22-201-22 |
| 26,0 cm, 10 ¹ / ₄ " | 07-22-200-26 | 07-22-201-26 |

**Korn- und Tupferzangen Sponge
and Dressing Forceps Pincas a
pansement et a éponges Pinzas
para vendajes y torundas
Зажимы для тампона**

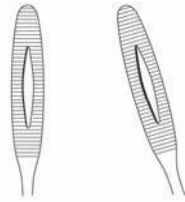

mit Sperre, with ratchet, avec crémaillère,
con cremallera, с кремальерой

18,0 cm, 7" **07-22-210-18 07-22-211-18**
 20,0 cm, 8" **07-22-210-20 07-22-211-20**
 22,0 cm, 8¾" **07-22-210-22 07-22-211-22**
 27,0 cm, 10¾" **07-22-210-27 07-22-211-27**

ohne Sperre, without ratchet, sans crémaillère,
sin cremallera, без кремальеры

18,0 cm, 7" **07-22-212-18 07-22-213-18**
 20,0 cm, 8" **07-22-212-20 07-22-213-20**
 25,0 cm, 9¾" **07-22-212-25 07-22-213-25**

GROSS-MAIER



25,0 cm, 9¾"
07-22-180-25

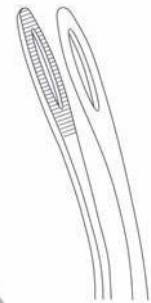

25,0 cm, 9¾"
07-22-181-25

FOERSTER



18,0 cm, 7" **07-22-160-18 07-22-161-18**
 20,0 cm, 8" **07-22-160-20 07-22-161-20**
 25,0 cm, 9¾" **07-22-160-25 07-22-161-25**



18,0 cm, 7" **07-22-170-18 07-22-171-18**
 20,0 cm, 8" **07-22-170-20 07-22-171-20**
 25,0 cm, 9¾" **07-22-170-25 07-22-171-25**

FOERSTER-BALLEGER



RAMPLEY

18,0 cm, 7" **07-22-190-18**
 25,0 cm, 9¾" **07-22-190-25**



PRESBYTERIAN
 16,0 cm, 6 $\frac{3}{4}$ " **07-23-012-16**
 18,0 cm, 7" **07-23-012-18**
 20,0 cm, 8" **07-23-012-20**
 22,0 cm, 8 $\frac{3}{4}$ " **07-23-012-22**



BERLIN
 14,5 cm, 5 $\frac{3}{4}$ "
07-23-006-14

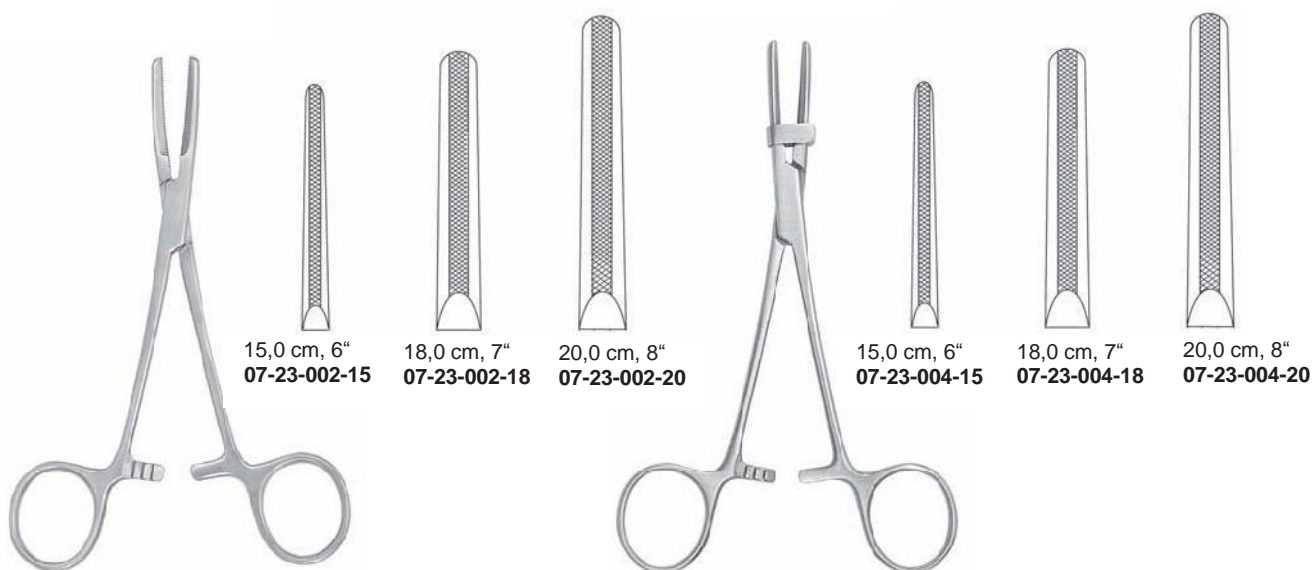

15,0 cm, 6"
07-23-002-15

18,0 cm, 7"
07-23-002-18

20,0 cm, 8"
07-23-002-20

15,0 cm, 6"
07-23-004-15

18,0 cm, 7"
07-23-004-18

20,0 cm, 8"
07-23-004-20

Klemmen
Forceps
Pinces
Pinas
Зажимы, щипцы



Bulldogklemmen
Bulldog Clamps
Clamps Bulldog
Clamps Bulldog
Зажимы типа „бульдог“



| | | |
|-------------|---------------------|---------------------|
| 3,5 cm, 1½" | 09-20-014-03 | 09-20-015-03 |
| 5,0 cm, 2" | 09-20-014-05 | 09-20-015-05 |



DIEFFENBACH



HESS
09-20-520-01



HESS
09-20-520-02



| | | |
|-------------|---------------------|---------------------|
| 4,0 cm, 1½" | 09-20-018-04 | 09-20-019-04 |
| 5,0 cm, 2" | 09-20-018-05 | 09-20-019-05 |
| 5,5 cm, 2½" | 09-20-018-06 | 09-20-019-55 |
| 6,5 cm, 2½" | 09-20-018-07 | 09-20-019-07 |
| 7,0 cm, 1½" | 09-20-018-08 | 09-20-019-08 |
| 7,5 cm, 3" | 09-20-018-09 | 09-20-019-09 |
| 9,0 cm, 3½" | 09-20-018-10 | 09-20-019-10 |

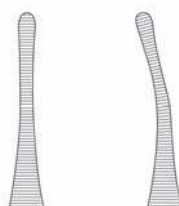

JOHNS-HOPKINS



JOHNS-HOPKINS
23,0 cm, 9"
09-20-295-23

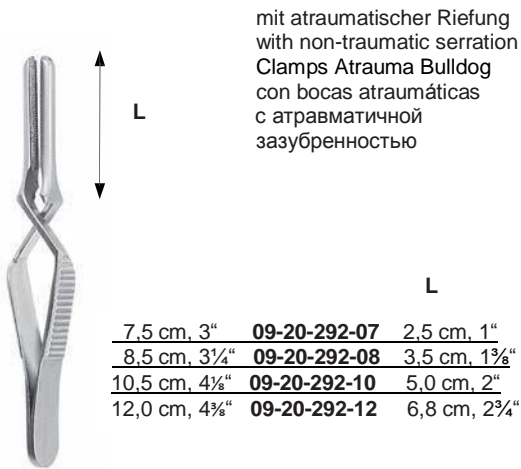

DE BAKEY

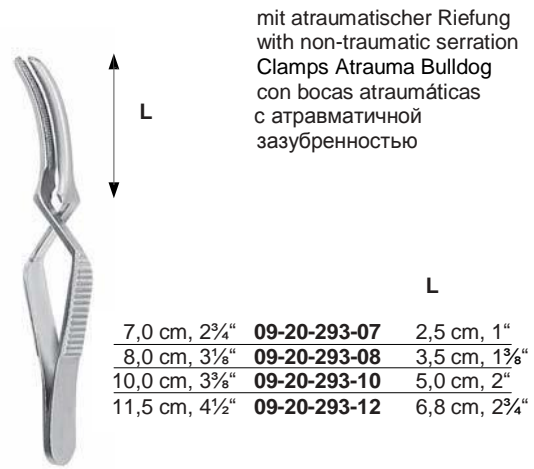

DE BAKEY



TITANIUM
3,5 cm, 1⅜" vena
09-21-032-35 arteria
09-21-042-35



TITANIUM
3,5 cm, 1⅜"
vena **09-21-033-35**
arteria **09-21-043-35**



TITANIUM
4,0 cm, 1⅝" vena
09-21-032-40 arteria
09-21-042-40



TITANIUM
4,0 cm, 1⅝" vena
09-21-033-40 arteria
09-21-043-40

Bulldogklemmen, Darm- und Gewebefaßzangen
Bulldog Clamps, Intestinal and Tissue Grasping Forceps
Clamps Bulldog, Pincers a saisir les intestins et les tissus
Clamps Bulldog, Pinzas intestinales y para tejidos
Зажимы типа „бульдог“, кишечные зажимы, зажимы для захватывания тканей

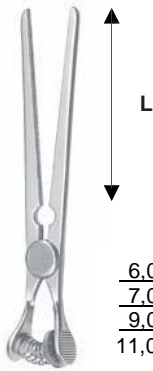

| | | |
|--|---------------------|---|
| 6,0 cm, 2 ³ / ₄ " | 09-20-298-06 | 3,3 cm, 1 ³ / ₈ " |
| 7,0 cm, 3 ³ / ₄ " | 09-20-298-07 | 5,0 cm, 2" |
| 9,0 cm, 3 ¹ / ₂ " | 09-20-298-09 | 6,0 cm, 2 ³ / ₄ " |
| 11,0 cm, 4 ³ / ₄ " | 09-20-298-11 | 6,9 cm, 2 ³ / ₄ " |

GLOVER

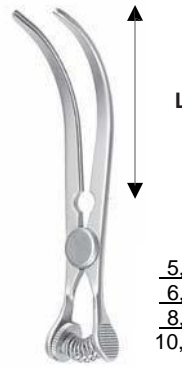

| | | |
|--|---------------------|---|
| 5,5 cm, 2" | 09-20-299-05 | 3,3 cm, 1 ³ / ₈ " |
| 6,5 cm, 2 ¹ / ₂ " | 09-20-299-06 | 3,3 cm, 1 ³ / ₈ " |
| 8,5 cm, 3" | 09-20-299-09 | 5,0 cm, 2" |
| 10,5 cm, 4 ³ / ₈ " | 09-20-299-11 | 6,9 cm, 2 ³ / ₄ " |

GLOVER



CHAPUT
 13,0 cm, 5"
09-24-370-13



TUFFIER
 13,0 cm, 5"
09-24-372-13



COLLIN
 16,0 cm, 6¹/₄"
09-24-376-16



15,5 cm, 6¼" 09-24-358-15
 20,0 cm, 8" 09-24-358-20



25,0 cm, 10"
 09-24-658-25

26,0 cm, 10¼"
 09-24-658-26

SCHEIBE



MARTEL
 14,0 cm, 5½"
 09-24-364-14



WILLET-MARTEL
 19,0 cm, 7¼"
 09-24-366-19



PRATT
 15,0 cm, 6"
 09-24-656-15



FERGUSSON

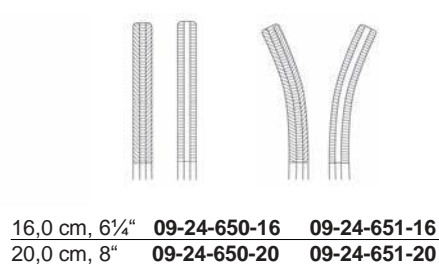

16,0 cm, 6¼" 09-24-650-16 09-24-651-16
 20,0 cm, 8" 09-24-650-20 09-24-651-20



CARREL
 8,5 cm, 3"
 09-24-010-08



TERRIER
 8,5 cm, 3" 09-24-016-08
 10,0 cm, 4" 09-24-016-10



KROENLEIN
 13,0 cm, 5"
 09-24-369-13



| | | |
|--------------|--------------|--------------|
| 13,0 cm, 5" | 09-24-368-13 | - |
| 14,0 cm, 5½" | 09-24-368-14 | 09-24-369-14 |
| 16,0 cm, 6¼" | 09-24-368-16 | 09-24-369-16 |

PEAN



09-24-475-01

09-24-475-02

BABY-MIXTER
14,0 cm, 5½"



| | | |
|--------------|--------------|--------------|
| 13,0 cm, 5" | 09-24-290-13 | 09-24-291-13 |
| 14,0 cm, 5½" | 09-24-290-14 | 09-24-291-14 |
| 15,0 cm, 6" | 09-24-290-15 | 09-24-291-15 |
| 18,0 cm, 7" | 09-24-290-18 | 09-24-291-18 |
| 20,0 cm, 8" | 09-24-290-20 | 09-24-291-20 |
| 23,0 cm, 9" | 09-24-290-23 | 09-24-291-23 |

SPENCER-WELLS



| | | |
|-------------|--------------|--------------|
| 9,0 cm, 3½" | 09-24-000-09 | 09-24-001-09 |
| 10,0 cm, 4" | 09-24-000-10 | 09-24-001-10 |

HARTMANN



PROVICENCE-HOSPITAL
 14,0 cm, 5½"

HALSTED-MOSQUITO

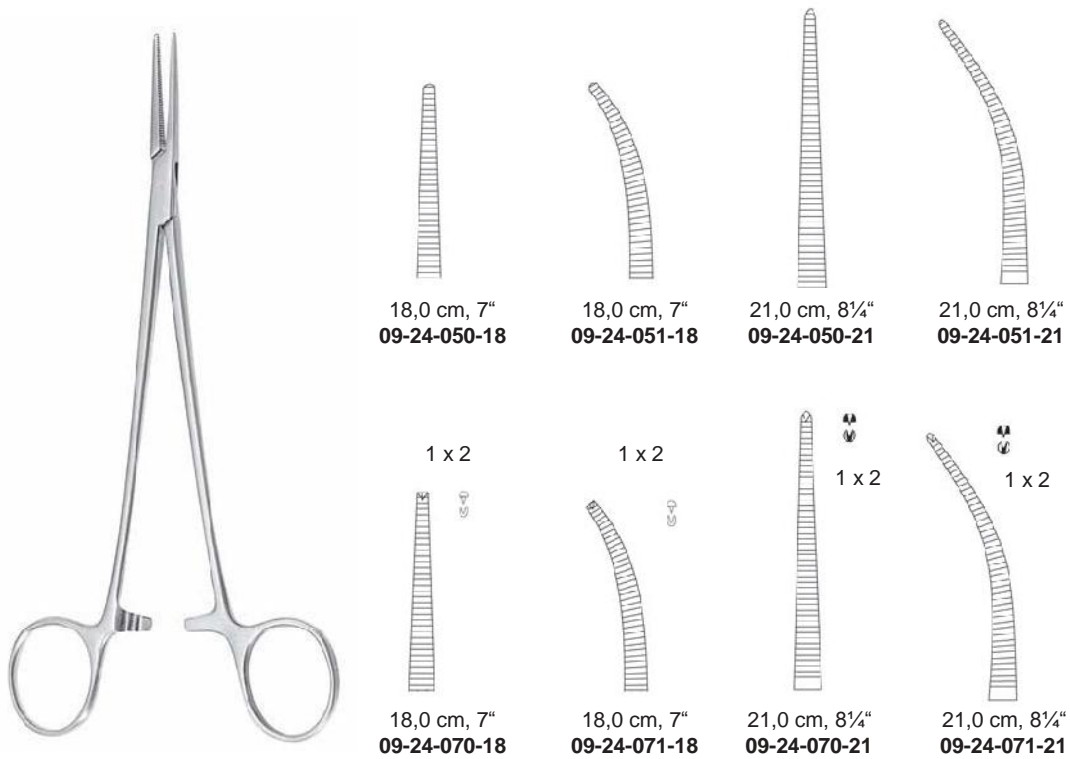

HALSTED-MOSQUITO



MICRO-MOSQUITO

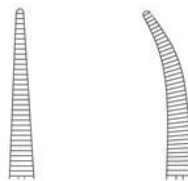

| | | |
|--|---------------------|---------------------|
| 10,0 cm, 4" | 09-24-020-10 | 09-24-021-10 |
| 12,5 cm, 4 ³ / ₄ " | 09-24-020-12 | 09-24-021-12 |

1 x 2 1 x 2

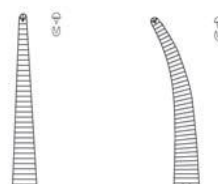

| | | |
|--|---------------------|---------------------|
| 10,0 cm, 4" | 09-24-030-10 | 09-24-031-10 |
| 12,5 cm, 4 ³ / ₄ " | 09-24-030-12 | 09-24-031-12 |



KELLY
14,0 cm, 5¹/₂"

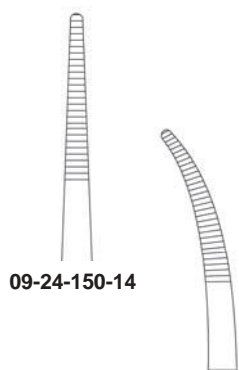

09-24-150-14

09-24-151-14



KELLY-RANKIN
16,0 cm, 6¹/₄"

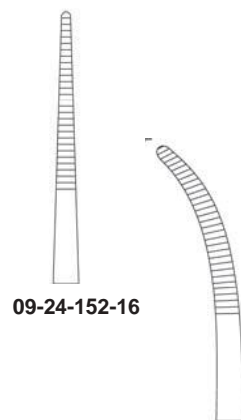

09-24-152-16

09-24-153-16



LERICHE
 15,0 cm, 6"



09-24-380-15

1 x 2



09-24-382-15



09-24-381-15

1 x 2



09-24-383-15



BABY-OVERHOLT
 13,5 cm, 5¼"
 09-24-424-14



DANDY
 14,0 cm, 5½"



09-24-345-14

1 x 2

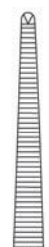

09-24-347-14



CRILE
 14,0 cm, 5½"



09-24-160-14

1 x 2



09-24-170-14



09-24-161-14

1 x 2



09-24-171-14



DIXON-LOVELACE
 15,5 cm, 6 $\frac{3}{4}$ "

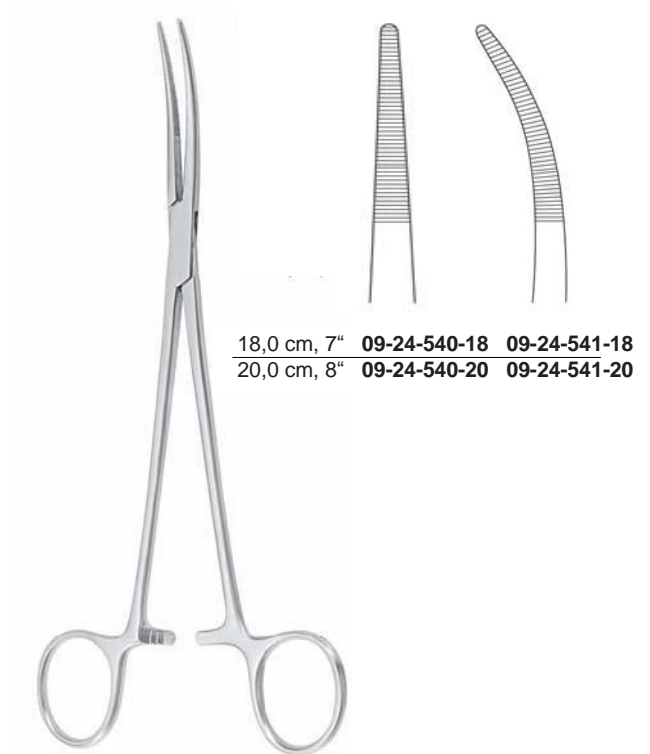

BIRKETT



CRILE-RANKIN
 16,0 cm, 6 $\frac{3}{4}$ "

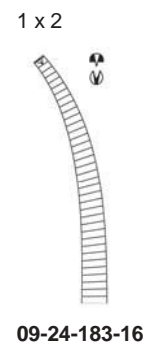
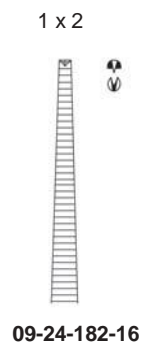
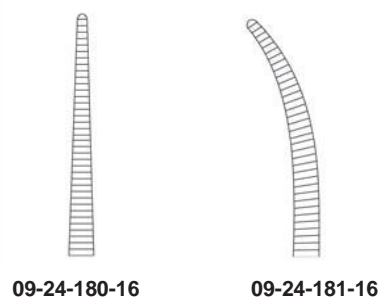

Arterienklemmen
 Haemostatic Forceps
 Pinces hémostatiques
 Pinzas hemostáticas
 Зажимы кровоостанавливающие

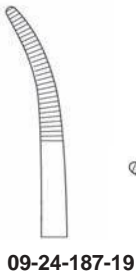

09-24-187-19



09-24-185-19

SCHMIDT
 19,0 cm, 7½"

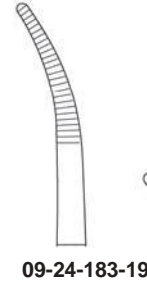

09-24-183-19



09-24-181-19

SCHMIDT-SAWTELL
 19,0 cm, 7½"

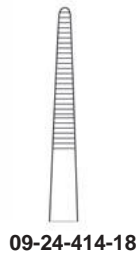
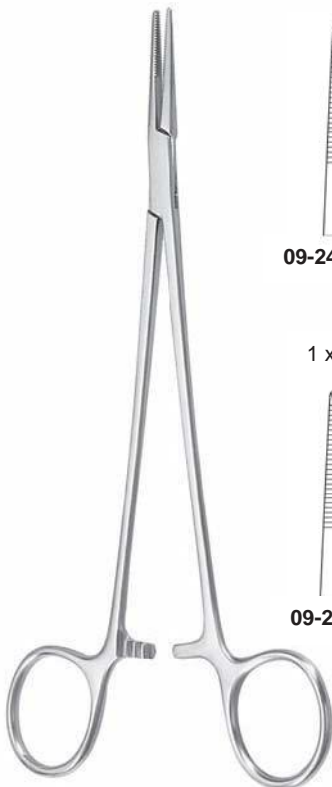

09-24-414-18



09-24-415-18

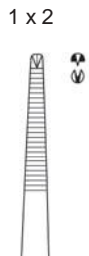

09-24-412-18



09-24-413-18

ADSON
 18,5 cm, 7¼"

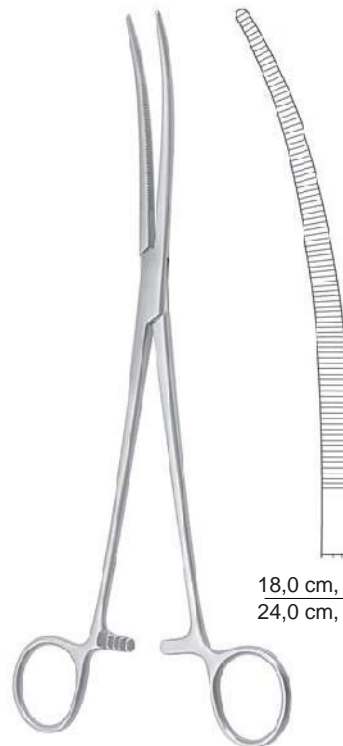

18,0 cm, 7" 09-24-453-18
 24,0 cm, 9½" 09-24-453-24

CRAFOORD



15,0 cm, 6" **09-24-480-15 09-24-481-15**
 18,5 cm, 7¼" **09-24-480-18 09-24-481-18**

BAINBRIDGE



16,0 cm, 6¼" **09-24-340-16 09-24-341-16**
 20,0 cm, 8" **09-24-340-20 09-24-341-20**

ROCHESTER-CARMALT



13,0 cm, 5" **09-24-262-13 09-24-263-13**
 14,0 cm, 5½" **09-24-262-14 09-24-263-14**
 16,0 cm, 6¼" **09-24-262-16 09-24-263-16**

PEAN DELICATE

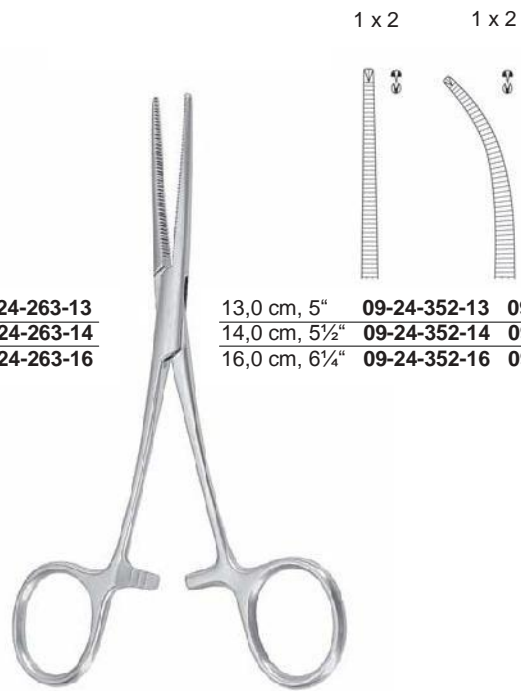

13,0 cm, 5" **09-24-352-13 09-24-353-13**
 14,0 cm, 5½" **09-24-352-14 09-24-353-14**
 16,0 cm, 6¼" **09-24-352-16 09-24-353-16**

KOCHER DELICATE



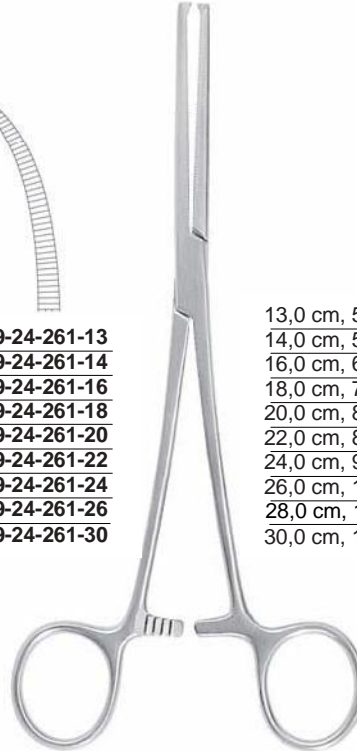

ROCHESTER-PEAN

| | | |
|---------------|--------------|--------------|
| 13,0 cm, 5" | 09-24-260-13 | 09-24-261-13 |
| 14,0 cm, 5½" | 09-24-260-14 | 09-24-261-14 |
| 16,0 cm, 6¼" | 09-24-260-16 | 09-24-261-16 |
| 18,0 cm, 7" | 09-24-260-18 | 09-24-261-18 |
| 20,0 cm, 8" | 09-24-260-20 | 09-24-261-20 |
| 22,0 cm, 8⅝" | 09-24-260-22 | 09-24-261-22 |
| 24,0 cm, 9½" | 09-24-260-24 | 09-24-261-24 |
| 26,0 cm, 10¼" | 09-24-260-26 | 09-24-261-26 |
| 30,0 cm, 12" | 09-24-260-30 | 09-24-261-30 |



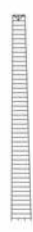

KOCHER-OCHSNER

| | | |
|---------------|---|---|
| | 1 x 2 | 1 x 2 |
| |  |  |
| 13,0 cm, 5" | 09-24-350-13 | 09-24-351-13 |
| 14,0 cm, 5½" | 09-24-350-14 | 09-24-351-14 |
| 16,0 cm, 6¼" | 09-24-350-16 | 09-24-351-16 |
| 18,0 cm, 7" | 09-24-350-18 | 09-24-351-18 |
| 20,0 cm, 8" | 09-24-350-20 | 09-24-351-20 |
| 22,0 cm, 8⅝" | 09-24-350-22 | 09-24-351-22 |
| 24,0 cm, 9½" | 09-24-350-24 | 09-24-351-24 |
| 26,0 cm, 10¼" | 09-24-350-26 | 09-24-351-26 |
| 28,0 cm, 11" | - | 09-24-351-28 |
| 30,0 cm, 12" | 09-24-350-30 | 09-24-351-30 |



BENGOLEA

| | | | |
|---------------|---|--|---|
| | | 1 x 2 | 1 x 2 |
| |  |  |  |
| 20,0 cm, 8" | 09-24-384-20 | 09-24-385-20 | 09-24-386-20 09-24-387-20 |
| 24,0 cm, 10¼" | 09-24-384-24 | 09-24-385-24 | 09-24-386-24 09-24-387-24 |
| 26,0 cm, 10¼" | 09-24-384-26 | 09-24-385-26 | 09-24-386-26 09-24-387-26 |



09-24-390-20 09-24-391-20 09-24-393-20

HEISS
 20,0 cm, 8"



09-24-448-22 09-24-449-22

ROBERTS
 22,0 cm, 8 5/8"



09-24-450-24 09-24-451-24

SAROT
 24,0 cm, 9 1/2"



09-24-533-01 09-24-533-02

NEGUS
 19,0 cm, 7 1/2"



BABY-ADSON

14,0 cm, 5½"
 09-24-411-14



18,0 cm, 7"
 09-24-411-18



MICRO-ADSON
 14,0 cm, 5½"
 09-24-409-14



OVERHOLT-MIXTER
 21,0 cm, 8¼"
 09-24-471-21



JOHNS HOPKINS
 20,0 cm, 8"
 09-24-497-20



BABY-MIXTER
 14,0 cm, 5½" 09-24-475-14
 16,0 cm, 6¼" 09-24-475-16
 18,0 cm, 7" 09-24-475-18



OVERHOLT

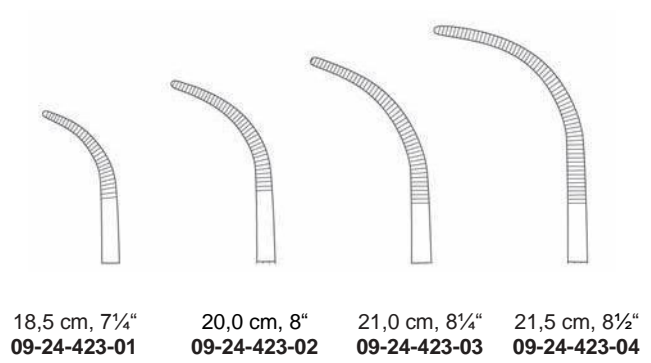

RUMEL
 23,0 cm, 9"

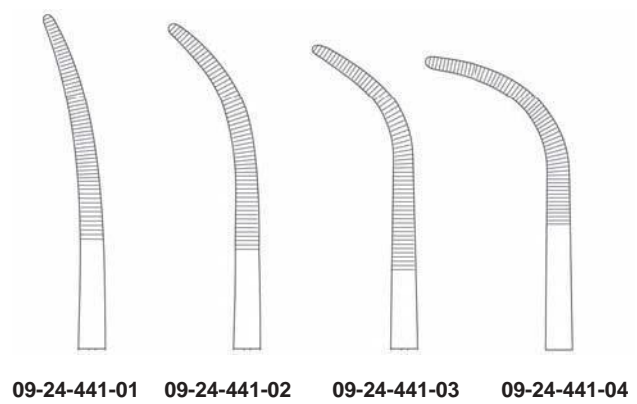

Präparier- und Ligaturklemmen
Dissecting and Ligature Forceps
Pinces a disséquer et a ligatures
Pinzas de disección y ligaduras
Зажимы анатомические и



OVERHOLT-GEISSENDOERFER
 21,0 cm, 8¼"

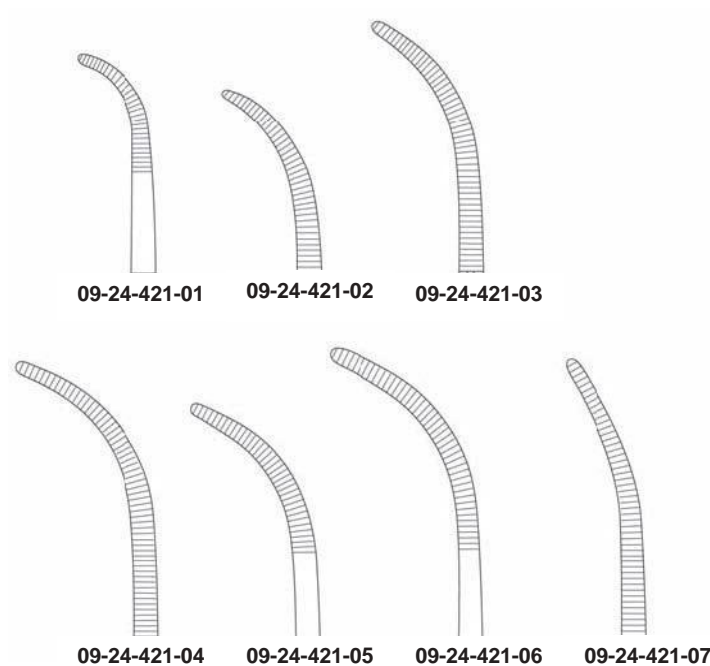

9



OVERHOLT-GEISSENDOERFER
 27,0 cm, 10¾"

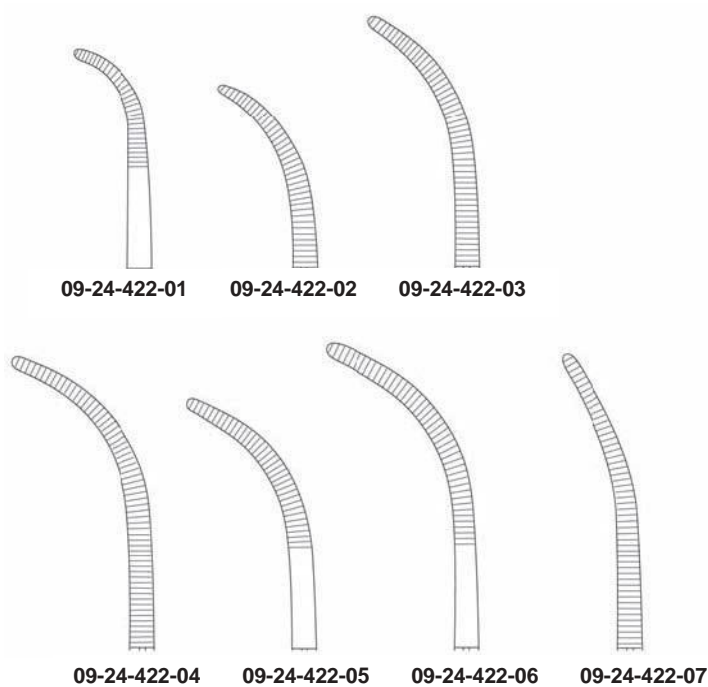

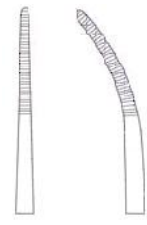

21,0 cm, 8¼" **09-24-442-21 09-24-443-21**
 26,0 cm, 10¼" **09-24-442-26 09-24-443-26**

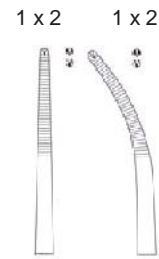

21,0 cm, 8¼" **09-24-444-21 09-24-445-21**
 26,0 cm, 10¼" **09-24-444-26 09-24-445-26**

TOENNIS



19,0 cm, 7½" **09-24-463-19 09-24-465-19 09-24-467-19**
 22,0 cm, 8⅝" **09-24-463-22 09-24-465-22 09-24-467-22**
 24,0 cm, 9½" **09-24-463-24 09-24-465-24 09-24-467-24**

KELLY



18,0 cm, 7" **09-24-429-18**
 22,0 cm, 8⁵/₈" **09-24-429-22**
 25,0 cm, 9³/₄" **09-24-429-25**
 28,0 cm, 11" **09-24-429-28**

MINI-GEMINI



13,0 cm, 5" **09-24-431-13**
 16,0 cm, 6¹/₄" **09-24-431-16**
 18,0 cm, 7" **09-24-431-18**
 20,0 cm, 8" **09-24-431-20**
 23,0 cm, 9" **09-24-431-23**
 25,0 cm, 9³/₄" **09-24-431-25**
 28,0 cm, 11" **09-24-431-28**

GEMINI



19,0 cm, 7¹/₂" **09-24-433-19**
 24,0 cm, 9¹/₂" **09-24-433-24**
 28,0 cm, 11" **09-24-433-28**

KANTROWITZ



19,0 cm, 7¹/₂" **09-24-543-19**
 21,0 cm, 8¹/₄" **09-24-543-21**
 24,0 cm, 9¹/₂" **09-24-543-24**

WIKSTROEM



15,5 cm, 6¼" 09-24-461-15
 19,0 cm, 7½" 09-24-461-19

MIXTER



15,5 cm, 6¼" 09-24-477-15
 19,0 cm, 7½" 09-24-477-19

MIXTER-O'SHAUGNESSY



MIXTER
 22,0 cm, 8¾" 09-24-473-22



MIXTER
 23,0 cm, 9" 09-24-473-23

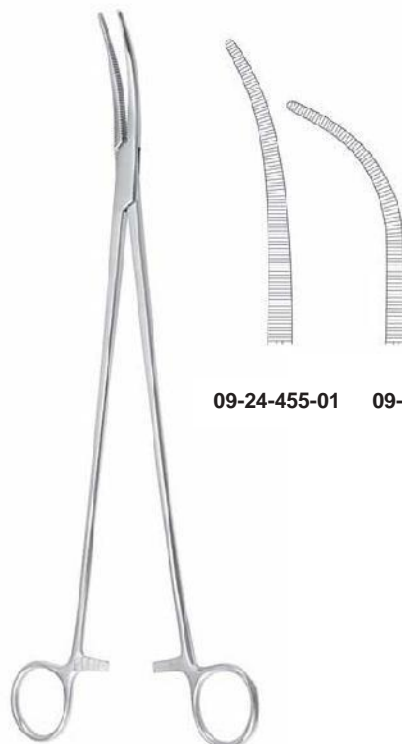

09-24-455-01 09-24-455-02

ZENKER
 29,5 cm, 11½"

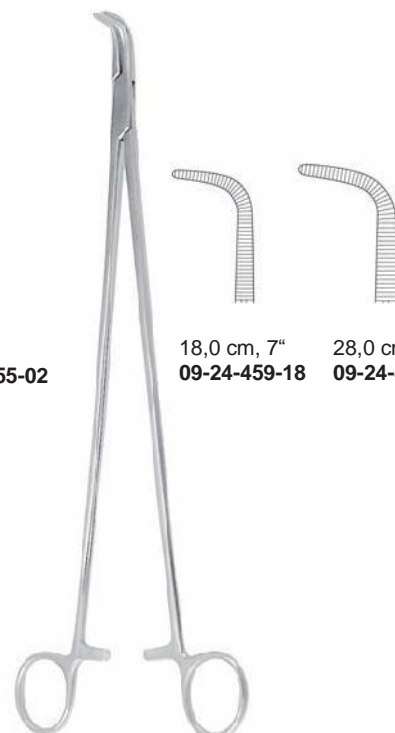

18,0 cm, 7" 09-24-459-18
 28,0 cm, 11" 09-24-459-28

MEEKER

Präparier- und Ligaturklemmen
Dissecting and Ligature Forceps
Pinces a disséquer et a ligatures
Pinzas de disección y ligaduras
Зажимы анатомические и



LAWRENCE
 27,5 cm, 10¾"
 09-24-457-28



HOSEMANN
 21,0 cm, 8¼"



DESJARDINS
 21,0 cm, 8¼"
 09-24-529-21

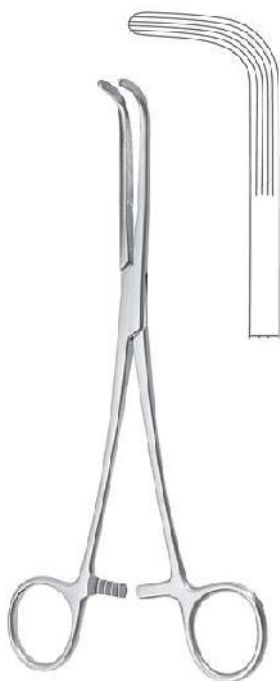

MIXTER
 22,0 cm, 8¾" 09-24-479-22
 25,0 cm, 9¾" 09-24-479-25
 28,0 cm, 11" 09-24-479-28

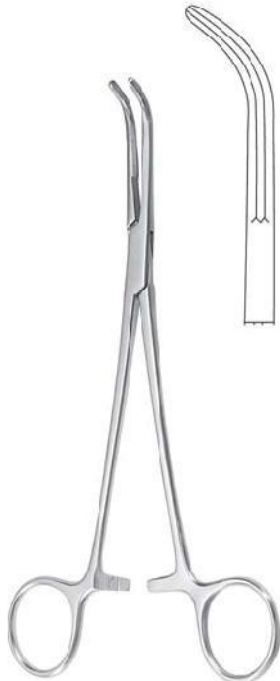

LAHEY
 19,0 cm, 7½" 09-24-501-19
 23,0 cm, 9" 09-24-501-23



LOWER
 18,0 cm, 7"
 09-24-503-18



MC QUIGG-MIXTER
 22,0 cm, 8¾"
09-24-507-22

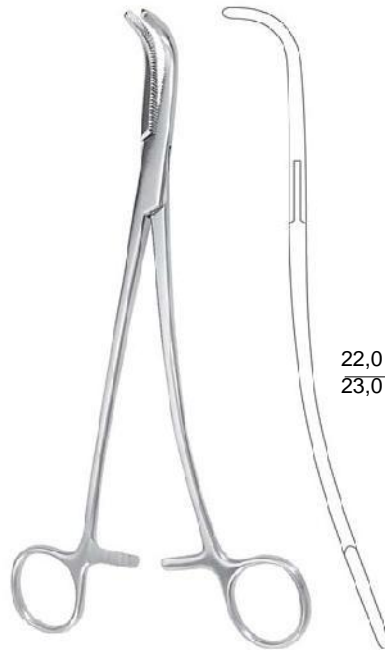

GRAY

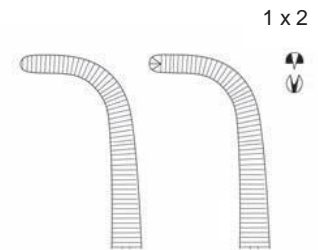

22,0 cm, 8¾" **09-24-523-22** **09-24-525-22**
 23,0 cm, 9" **09-24-523-23** **09-24-525-23**



CRAFOORD-SELLORS

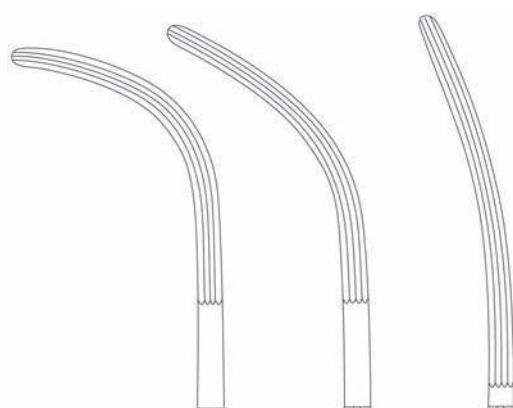

22,0 cm, 8¾" **09-24-456-22**
 23,0 cm, 9" **09-24-456-23**
 24,0 cm, 9½" **09-24-456-24**

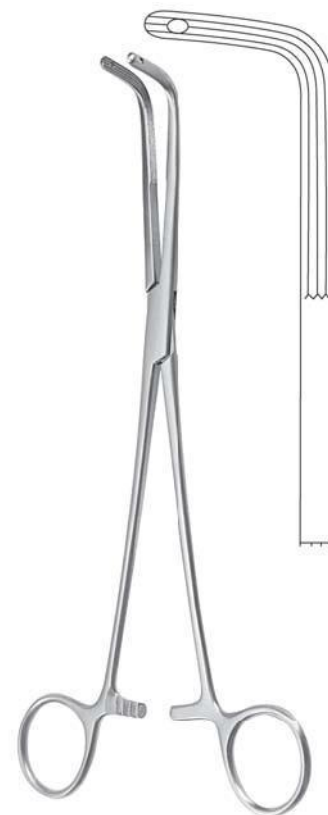

FINOCCHIETTO
 24,0 cm, 9½"
09-24-505-24

Gallenkanal- und Nierenstielklemmen, Bronchusklemmen
 Gall Duct and Kidney Pedicle Clamps, Bronchus Forceps
 Pince-clamps pour pédiculés rénaux,
 Pincés pour les voies biliaires, Bronches pincer



20,0 cm, 8" 09-24-509-20
 22,0 cm, 8³/₄" 09-24-509-22
 24,0 cm, 9¹/₂" 09-24-509-24

GUYON



GUYON
 23,0 cm, 9"
 09-24-513-23



23,0 cm, 9" 09-24-519-23
 24,0 cm, 9¹/₂" 09-24-519-24

GUYON



STILLE
 23,0 cm, 9"
 09-24-511-23

Gallenkanal- und Nierenstielklemmen
Gall Duct and Kidney Pedicle Clamps
Pince-clamps pour pédiculés rénaux, Pincés pour les voies biliaires
Pinzas-clamps para pedúnculo renal, Pinzas para conducto biliar
Зажим для желчного протока и для почечной ножки

Pinzas-clamps para pedúnculo renal, Pinzas-clamps para bronquios
Зажим для желчного протока и для почечной ножки, бронхиальный зажим



HERRICK
 23,0 cm, 9"
09-24-517-23



URO-TANGENTIAL
 26,0 cm, 10¼"

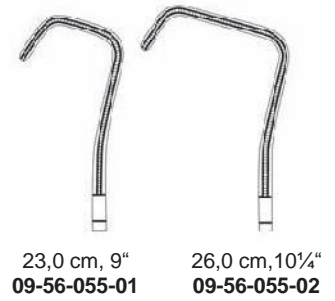

23,0 cm, 9"
09-56-055-01

26,0 cm, 10¼"
09-56-055-02



LOVELACE
 20,0 cm, 8"
09-48-004-20



LOVELACE
 20,0 cm, 8"
09-48-005-20



PRICE-THOMAS
 22,0 cm, 8¾"
09-48-001-22

Peritoneumklemmen, Hysterektomieklemmen
 Peritoneum Forceps, Hysterectomy Forceps
 Pincas a péritoine, Pincas a hystérectomie

para peritoneo y para histerectomía
 Бронхеальные зажимы, щипцы для брюшины,
 Щипцы гистерэктомические



PRICE-THOMAS
 22,0 cm, 8¾"

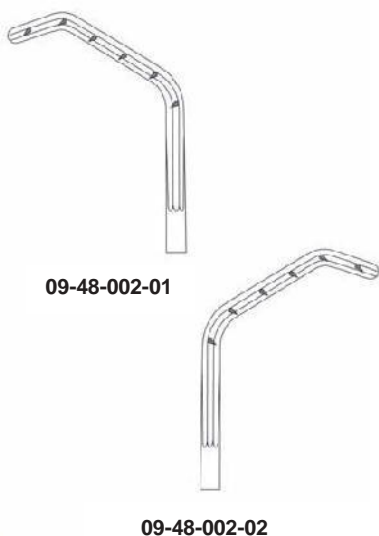

09-48-002-01

09-48-002-02



SEMB
 23,0 cm, 9"

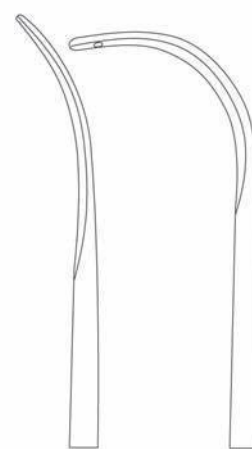

09-48-003-01 09-48-003-02



BABY-MIKULICZ
 14,0 cm, 5½"
 09-24-701-14



MIKULICZ
 18,0 cm, 7"
 09-24-703-18



MIKULICZ
 20,0 cm, 8"
 09-24-709-20

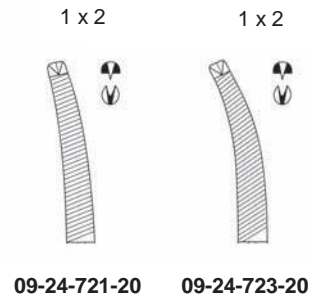

FAURE
 20,0 cm, 8"

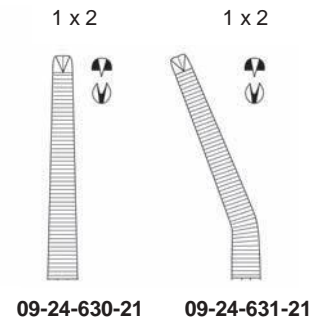

PHANEUF
 21,5 cm, 8½"

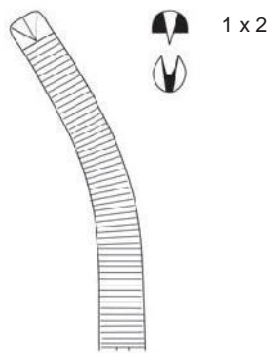

WERTHEIM
 22,0 cm, 8¾"
 09-24-601-22



WERTHEIM
 25,0 cm, 10"
 09-24-602-25



WERTHEIM

MAINGOT



MOYNIHAN

WERTHEIM-CULLEN

21,5 cm, 8½"
09-24-629-21



LONG
 19,0 cm, 7¼"
 09-24-621-19

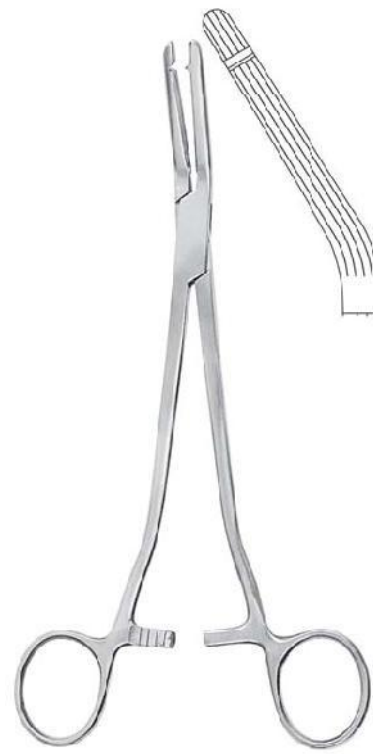

GARLAND
 21,0 cm, 8¼"
 09-24-623-21



HEANEY-BALLANTINE
 21,0 cm, 8¼"



HEANEY-KANTER
 21,0 cm, 8¼"
 09-24-617-21

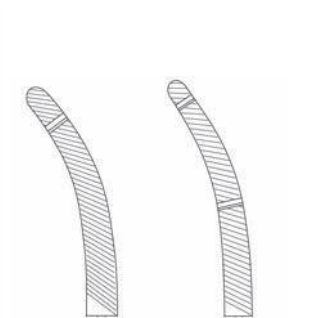

| | | |
|--------------|---------------------|---------------------|
| 21,0 cm, 8¼" | 09-24-611-21 | 09-24-613-21 |
| 23,0 cm, 9" | 09-24-611-23 | 09-24-613-23 |

HEANEY

Nahtinstrumente
Suture Instruments
Instrumente a sutura
Instrumentos para sutura
Шовный инструмент



**Nadelhalter
Needle Holders
Porte-aiguilles
Porta-agujas
Иглодержатели**



12,0 cm, 4¾"
11-25-010-12

12,5 cm, 5"
11-25-020-12

DERF



COLLIER
12,5 cm, 5"
11-25-022-12



WEBSTER
13,0 cm, 5"
11-25-028-13

11

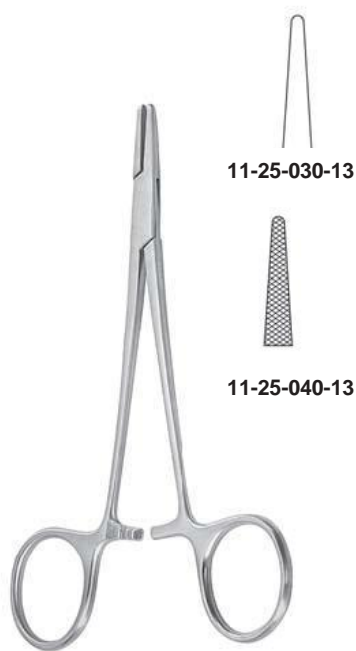

11-25-030-13

11-25-040-13

HALSEY
13,0 cm, 5"



NEIVERT
13,0 cm, 5"
11-25-046-13



HEGAR-BAUMGARTNER
12,5 cm, 4¾" 11-25-048-12
14,0 cm, 5½" 11-25-048-14



13,0 cm, 5" **11-25-096-13**
 18,0 cm, 7" **11-25-096-18**

BROWN



CRILE-MURRAY
 15,0 cm, 6"
11-25-070-15



15,0 cm, 6" **11-25-060-15**
 18,0 cm, 7" **11-25-060-18**
 20,0 cm, 8" **11-25-060-20**
 23,0 cm, 9" **11-25-060-23**

CRILE-WOOD



ADSON
 16,0 cm, 6³/₄" **11-25-192-16**
 18,0 cm, 7" **11-25-192-18**

ADSON



METZENBAUM
 18,0 cm, 7"
11-25-190-18

METZENBAUM



MASS.-GENERAL-HOSPITAL
 17,0 cm, 6³/₄"
11-25-072-17

MASS.-GENERAL-HOSPITAL



MAYO-HEGAR



14,0 cm, 5½"
11-25-080-14



16,0 cm, 6¾"
11-25-080-16



18,0 cm, 7"
11-25-080-18



20,0 cm, 8"
11-25-080-20



24,0 cm, 9½"
11-25-080-24



26,0 cm, 10¼"
11-25-080-26



30,0 cm, 12"
11-25-080-30



MAYO-HEGAR-DELICATE



16,0 cm, 6¼"
11-25-090-16

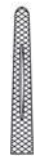

18,0 cm, 7"
11-25-090-18



20,0 cm, 8"
11-25-090-20



LAWRENCE
15,0 cm, 6"
11-25-110-15





HEANEY
 21,0 cm, 8¼"
 11-25-141-21



JAMISON
 23,5 cm, 9¼"
 11-25-148-23



MASSON
 27,0 cm, 10½"
 11-25-150-27



FINOCCHIETTO
 20,0 cm, 8" 11-25-211-20
 27,0 cm, 10½" 11-25-211-27



WANGENSTEEN
 27,0 cm, 10½"
 11-25-160-27



JOHNSON
 27,0 cm, 10½"
 11-25-193-27

**Nadelhalter
Needle Holders
Porte-aiguilles
Porta-agujas
Иглодержатели**

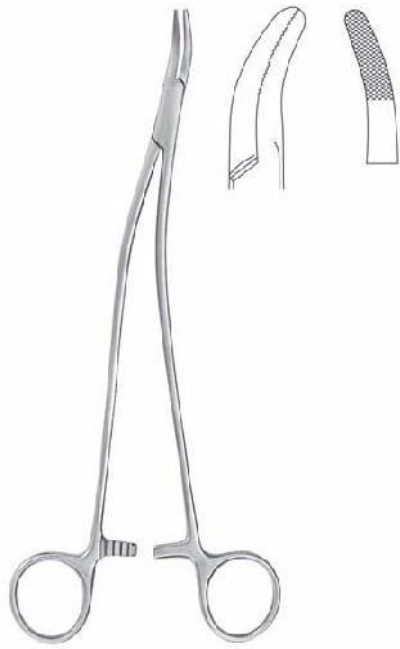

STRATTE
23,0 cm, 9"
11-25-230-23



OLSEN-HEGAR
17,0 cm, 6¾"
11-25-310-17



OLSEN-HEGAR
14,0 cm, 5½"
11-25-306-14

11



OLSEN-HEGAR

| | |
|--------------|-----------------------|
| 14,0 cm, 5½" | 11-25-310-14 |
| 17,0 cm, 6¾" | 11-25-310-17.1 |
| 18,0 cm, 7" | 11-25-310-18 |
| 19,0 cm, 7½" | 11-25-310-19 |



TOENNIS
18,0 cm, 7"
11-25-362-18



MATHIEU



Fig. 1



Fig. 2



Fig. 3

| | | | |
|--------------|----------------|----------------|----------------|
| 14,0 cm, 5½" | 11-25-350-14.1 | 11-25-350-14.2 | 11-25-350-14.3 |
| 17,0 cm, 6¾" | 11-25-350-17.1 | 11-25-350-17.2 | 11-25-350-17.3 |
| 20,0 cm, 8" | 11-25-350-20.1 | 11-25-350-20.2 | 11-25-350-20.3 |
| 24,0 cm, 9½" | 11-25-350-24.1 | 11-25-350-24.2 | 11-25-350-24.3 |



MATHIEU



14,0 cm, 5½"
11-25-356-14



17,0 cm, 6¾"
11-25-356-17



20,0 cm, 8"
11-25-356-20



LICHTENBERG



| | |
|--------------|--------------|
| 14,0 cm, 5½" | 11-25-366-14 |
| 17,0 cm, 6¾" | 11-25-366-17 |
| 20,0 cm, 8" | 11-25-366-20 |



MATHIEU



Fig. 1

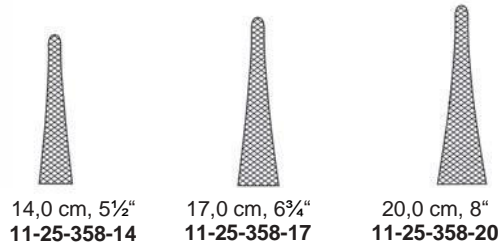

Fig. 2



Fig. 3

| | | | |
|--------------|----------------|----------------|----------------|
| 14,0 cm, 5½" | 11-25-354-14.1 | 11-25-354-14.2 | 11-25-354-14.3 |
| 17,0 cm, 6¾" | 11-25-354-17.1 | 11-25-354-17.2 | 11-25-354-17.3 |
| 20,0 cm, 8" | 11-25-354-20.1 | 11-25-354-20.2 | 11-25-354-20.3 |



14,0 cm, 5½"
11-25-358-14

17,0 cm, 6¾"
11-25-358-17

20,0 cm, 8"
11-25-358-20



11-25-550-10

11-25-551-10

ohne Sperre
without ratchet
sans serrure
sin cremallera
без кремальеры



MATHIEU-KOCHER

BARRAQUER-TROUTMAN
10,0 cm, 4"



11-25-553-11

11-25-553-13

ohne Sperre
without ratchet
sans serrure
sin cremallera
без кремальеры



mit Sperre with
ratchet avec
serrure con
cremallera
с кремальерой



ohne Sperre
without ratchet
sans serrure
sin cremallera
без кремальеры

BARRAQUER
10,0 cm, 4"

BARRAQUER
13,5 cm, 5½"
11-25-621-13

GOMEL
14,0 cm, 5½"
11-25-601-14



18,5 cm, 7¼"

11-25-600-18

11-25-601-18

11-25-602-18

11-25-603-18

ohne Sperre
without ratchet
sans serrure
sin cremallera
без кремальеры



18,5 cm, 7¼"

11-25-630-18

11-25-631-18

11-25-632-18

11-25-633-18

mit Sperre with
ratchet avec
serrure con
cremallera
с кремальерой



CASTROVIEJO

ohne Sperre
without ratchet
sans serrure
sin cremallera,
без кремальеры



| | | |
|--------------|---------------------|---------------------|
| 9,0 cm, 3½" | 11-25-570-09 | 11-25-571-09 |
| 14,0 cm, 5½" | 11-25-570-14 | 11-25-571-14 |
| 18,0 cm, 7" | 11-25-570-18 | 11-25-571-18 |

mit Sperre, with
ratchet avec
serrure con
cremallera, с
кремальерой



| | | |
|--------------|---------------------|---------------------|
| 9,0 cm, 3½" | 11-25-576-09 | 11-25-577-09 |
| 14,0 cm, 5½" | 11-25-576-14 | 11-25-577-14 |
| 18,0 cm, 7" | 11-25-576-18 | 11-25-577-18 |

0,4 mm



gerade, ohne Sperre
 straight, without ratchet
 droit, sans serrure
 recta, sin cremallera
 прямые, без
 кремальеры

14,0 cm, 5½"
 11-25-650-14

0,4 mm



gebogen, ohne Sperre
 curved, without ratchet
 courbe, sans serrure
 curva, sin cremallera
 изогнутые,
 без кремальеры

14,0 cm, 5½"
 11-25-651-14

0,4 mm



gebogen, mit Sperre
 curved, with ratchet
 courbe, avec serrure
 curva, con cremallera
 изогнутые,
 с кремальерой

14,0 cm, 5½"
 11-25-653-14

11

0,5 mm



gebogen, ohne Sperre
 curved, without ratchet
 courbe, sans serrure
 curva, sin cremallera
 изогнутые, без кремальеры

Ø 8 mm

14,0 cm, 5½"
 11-25-663-14

0,4 mm



gebogen, ohne Sperre
 curved, without ratchet
 courbe, sans serrure
 curva, sin cremallera
 изогнутые, без кремальеры

Ø 8 mm

13,0 cm, 5"
 11-25-673-13



11-26-428-14 11-26-429-14

11-26-430-14 11-26-431-14

KALT
 13,5 cm, 5³/₈"
 1126-428-14



DIETHRICH

| | | |
|---|--------------|--------------|
| 16,0 cm, 6 ³ / ₄ " | 11-26-250-16 | 11-26-251-16 |
| 18,0 cm, 7" | 11-26-250-18 | 11-26-251-18 |
| 20,0 cm, 8" | 11-26-250-20 | 11-26-251-20 |
| 23,0 cm, 9" | 11-26-250-23 | 11-26-251-23 |
| 26,0 cm, 10 ¹ / ₄ " | 11-26-250-26 | 11-26-251-26 |



WEBSTER
 13,0 cm, 5"
 11-26-028-13



DERF
 12,0 cm, 4³/₄"
 11-26-010-12



HEGAR-BAUMGARTNER

12,5 cm, 5"
 11-26-048-12

14,0 cm, 5¹/₂"
 11-26-048-14



WEBSTER
 13,0 cm, 5"
 11-26-029-13

Nadelhalter mit Hartmetalleinlagen
Needle Holders with tungsten carbide inserts
Porte-aiguilles avec inserts en carbure tungstène
Porta-agujas con bocas de carburo tungsteno
Иглодержатели с твердосплавной вставкой



HALSEY
13,0 cm, 5"

11-26-030-13



11-26-040-13



CRILE-WOOD

| | |
|-------------|---------------------|
| 15,0 cm, 6" | 11-26-060-15 |
| 18,0 cm, 7" | 11-26-060-18 |
| 20,0 cm, 8" | 11-26-060-20 |
| 23,0 cm, 9" | 11-26-060-23 |



11



SAROT



Fig. 1

18,0 cm, 7"
11-26-224-18



Fig. 2

20,0 cm, 8"
11-26-224-20



Fig. 3

26,0 cm, 10¼"
11-26-224-26



MAYO-HEGAR



16,0 cm, 6¼"
11-26-080-16



18,0 cm, 7"
11-26-080-18



20,0 cm, 8"
11-26-080-20



24,0 cm, 8"
11-26-080-24



26,0 cm, 10¼"
11-26-080-26



30,0 cm, 12"
11-26-080-30



MAYO-HEGAR (HEANEY)



20,0 cm, 8"
11-26-141-20



24,0 cm, 9¼"
11-26-141-24







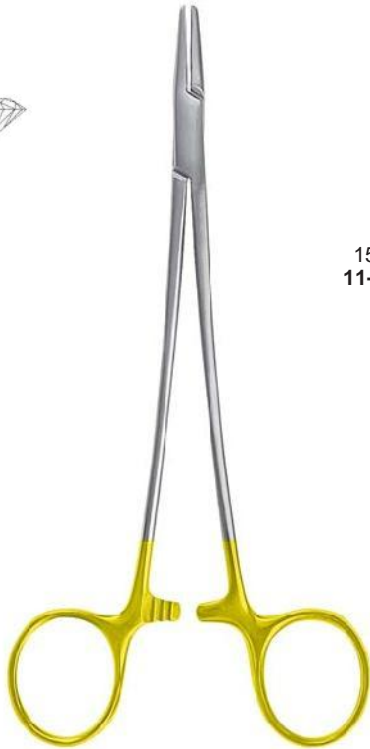

26,0 cm, 10¼"
11-26-141-26

Nadelhalter mit Hartmetalleinlagen
Needle Holders with tungsten carbide inserts
Porte-aiguilles avec inserts en carbure tungstène
Porta-agujas con bocas de carburo tungsteno
Иглодержатели с твердосплавной вставкой





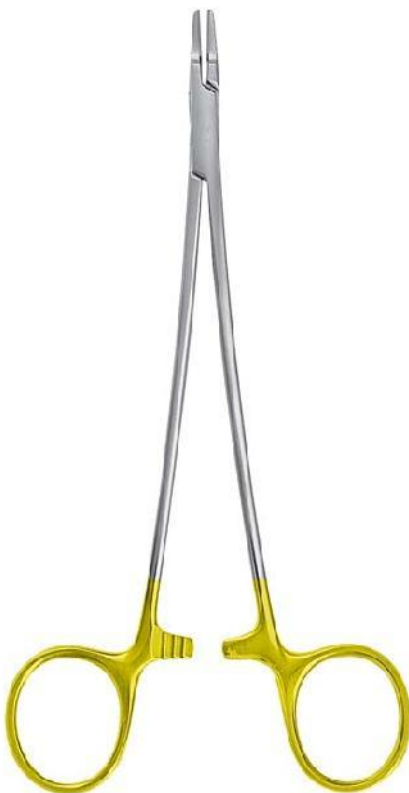

DE BAKEY

| | | | |
|---|--|---|---|
|  |  |  |  |
| 15,0 cm, 6" 11-26-114-15 | 18,0 cm, 7" 11-26-114-18 | 20,0 cm, 8" 11-26-114-20 | 23,0 cm, 9" 11-26-114-23 |
|  |  |  | |
| 26,0 cm, 10 ¹ / ₄ " 11-26-114-26 | 31,0 cm, 12 ¹ / ₄ " 11-26-114-31 | 37,0 cm, 14 ¹ / ₂ " 11-26-114-37 | |

11

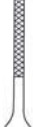

RYDER-VASCULAR

| | | |
|---|--|---|
|  |  |  |
| 13,0 cm, 5" 11-26-132-13 | 15,0 cm, 6" 11-26-132-15 | 18,0 cm, 7" 11-26-132-18 |
|  |  |  |
| 20,0 cm, 8" 11-26-132-20 | 23,0 cm, 9" 11-26-132-23 | 26,0 cm, 10 ¹ / ₄ " 11-26-132-26 |



RYDER

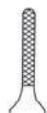

13,0 cm, 5"
11-26-134-13

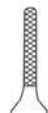

15,0 cm, 6"
11-26-134-15



18,0 cm, 7"
11-26-134-18

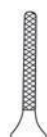

20,0 cm, 8"
11-26-134-20

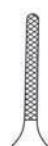

23,0 cm, 9"
11-26-134-23

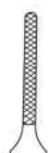

26,0 cm, 10½"
11-26-134-26



SCHWEDISCHES MODELL
 15,0 cm, 6"
 11-26-136-15

Nadelhalter mit Hartmetalleinlagen
Needle Holders with tungsten carbide inserts
Porte-aiguilles avec inserts en carbure tungstène
Porta-agujas con bocas de carburo tungsteno
Иглодержатели с твердосплавной вставкой

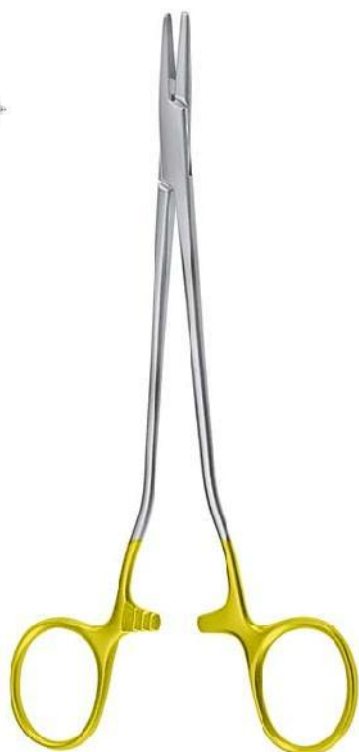

SAROT



Fig. 1

18,0 cm, 7"
 11-26-090-18



Fig. 2

20,0 cm, 8"
 11-26-090-20



Fig. 3

26,0 cm, 9"
 11-26-090-26

11



FINOCCHIETTO
 20,0 cm, 8" 11-26-211-20
 27,0 cm, 10¾" 11-26-211-27



MASSON
 27,0 cm, 10½"
 11-26-150-27



WANGENSTEEN
 27,0 cm, 10½"
 11-26-160-27

Nadelhalter mit Hartmetalleinlagen
Holders with tungsten carbide inserts
Porte-aiguilles avec inserts en carbure tungstène
Porta-agujas con bocas de carburo tungsteno
Иглодержатели с твердосплавной вставкой



BOZEMANN



20,0 cm, 8"
11-26-185-20



24,0 cm, 9⁵/₈"
11-26-185-24



26,0 cm, 10¹/₄"
11-26-185-26



HEGAR



20,0 cm, 8"
11-26-084-20



24,0 cm, 9⁵/₈"
11-26-084-24



BARRY STERNAL



15,0 cm, 6"
11-26-240-15



20,0 cm, 8"
11-26-242-20

Nadelhalter mit Hartmetalleinlagen
Needle Holders with tungsten carbide inserts
Porte-aiguilles avec inserts en carbure tungstène
Porta-agujas con bocas de carburo tungsteno
Иглодержатели с твердосплавной вставкой

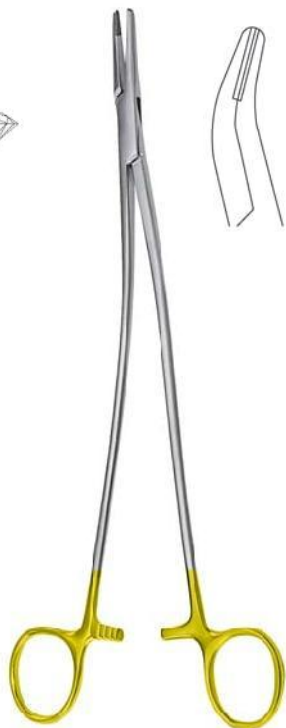

STRATTE



22,0 cm, 8 $\frac{5}{8}$ "
 11-26-230-22



23,0 cm, 9"
 11-26-230-23



GILLIES
 16,0 cm, 6 $\frac{1}{4}$ "
 11-26-330-16

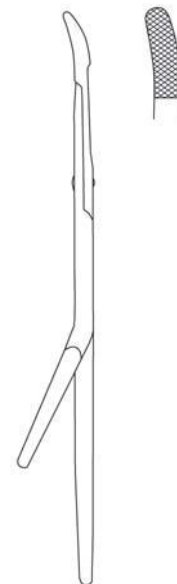

11



OLSEN-HEGAR



14,0 cm, 5 $\frac{1}{2}$ "
 11-26-310-14



17,0 cm, 6 $\frac{3}{4}$ "
 11-26-310-17



18,0 cm, 7"
 11-26-310-18



TOENNIS
 18,0 cm, 7"
 11-26-362-18



MATHIEU-KOCHER

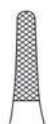

Fig. 1

14,0 cm, 5½"
11-26-358-14



Fig. 2

17,0 cm, 6¾"
11-26-358-17



Fig. 3

20,0 cm, 8"
11-26-358-20



Fig. 4

24,0 cm, 9½"
11-26-358-24



MATHIEU



Fig. 1

14,0 cm, 5½"
11-26-350-14



Fig. 2

17,0 cm, 6¾"
11-26-350-17



Fig. 3

20,0 cm, 8"
11-26-350-20



Fig. 4

24,0 cm, 9½"
11-26-350-24

Nadelhalter mit Hartmetalleinlagen
Needle Holders with tungsten carbide inserts
Porte-aiguilles avec inserts en carbure tungstène
Porta-agujas con bocas de carburo tungsteno
Иглодержатели с твердосплавной вставкой



LICHTENBERG



Fig. 1



Fig. 2



Fig. 3

| | | | |
|--------------|---------------------|---------------------|---------------------|
| 14,0 cm, 5½" | 11-26-366-14 | 11-26-367-14 | 11-26-368-14 |
| 17,0 cm, 6¾" | 11-26-366-17 | 11-26-367-17 | 11-26-368-17 |
| 20,0 cm, 8" | 11-26-366-20 | 11-26-367-20 | 11-26-368-20 |

11



MATHIEU



Fig. 1



Fig. 2



Fig. 3

| | | |
|---------------------|---------------------|---------------------|
| 17,0 cm, 6¾" | 20,0 cm, 8" | 23,0 cm, 9" |
| 11-26-356-17 | 11-26-356-20 | 11-26-356-23 |



ZWEIFEL



20,0 cm, 8"
11-26-364-20



23,0 cm, 9"
11-26-364-23



HEPP SCHEIDEL



18,0 cm, 7"
11-26-390-18



LANGENBECK



Fig. 1
18,0 cm, 7"
11-26-360-18



Fig. 2
20,0 cm, 8"
11-26-360-20



Fig. 3
23,0 cm, 9"
11-26-360-23

Nadelhalter mit Hartmetalleinlagen
Needle Holders with tungsten carbide inserts
Porte-aiguilles avec inserts en carbure tungstène
Porta-agujas con bocas de carburo tungsteno
Иглодержатели с твердосплавной вставкой



| | | |
|--------------|--------------|--------------|
| 14,0 cm, 5½" | 11-26-570-14 | 11-26-571-14 |
| 18,0 cm, 7" | 11-26-570-18 | 11-26-571-18 |
| 22,0 cm, 8¾" | 11-26-570-22 | 11-26-571-22 |

| | | |
|--------------|--------------|--------------|
| 14,0 cm, 5½" | 11-26-576-14 | 11-26-577-14 |
| 18,0 cm, 7" | 11-26-576-18 | 11-26-577-18 |
| 22,0 cm, 8¾" | 11-26-576-22 | 11-26-577-22 |

ohne Sperre
 without ratchet
 sans serrure
 sin cremallera
 без кремальеры

CASTROVIEJO



| | | |
|--------------|--------------|--------------|
| 14,0 cm, 5½" | 11-26-572-14 | 11-26-573-14 |
| 18,0 cm, 7" | 11-26-572-18 | 11-26-573-18 |
| 22,0 cm, 8¾" | 11-26-572-22 | 11-26-573-22 |

| | | |
|--------------|--------------|--------------|
| 14,0 cm, 5½" | 11-26-574-14 | 11-26-575-14 |
| 18,0 cm, 7" | 11-26-574-18 | 11-26-575-18 |
| 22,0 cm, 8¾" | 11-26-574-22 | 11-26-575-22 |

mit Sperre with
 ratchet avec
 serrure con
 cremallera
 с кремальерой

CASTROVIEJO



| | | |
|--------------|--------------|--------------|
| 14,0 cm, 5½" | 11-26-560-14 | 11-26-561-14 |
| 18,0 cm, 7" | 11-26-560-18 | 11-26-561-18 |
| 21,0 cm, 8¼" | 11-26-560-21 | 11-26-561-21 |

| | | |
|--------------|--------------|--------------|
| 14,0 cm, 5½" | 11-26-562-14 | 11-26-563-14 |
| 18,0 cm, 7" | 11-26-562-18 | 11-26-563-18 |
| 21,0 cm, 8¼" | 11-26-562-21 | 11-26-563-21 |

mit Sperre with
 ratchet avec
 serrure con
 cremallera
 с кремальерой

BARRAQUER



| | | |
|--------------|--------------|--------------|
| 14,0 cm, 5½" | 11-26-578-14 | 11-26-579-14 |
| 18,0 cm, 7" | 11-26-578-18 | 11-26-579-18 |

| | | |
|--------------|--------------|--------------|
| 14,0 cm, 5¼" | 11-26-581-14 | 11-26-582-14 |
| 18,0 cm, 7" | 11-26-581-18 | 11-26-582-18 |

ohne Sperre
 without ratchet
 sans serrure
 sin cremallera
 без кремальеры

BARRAQUER



REVERDIN

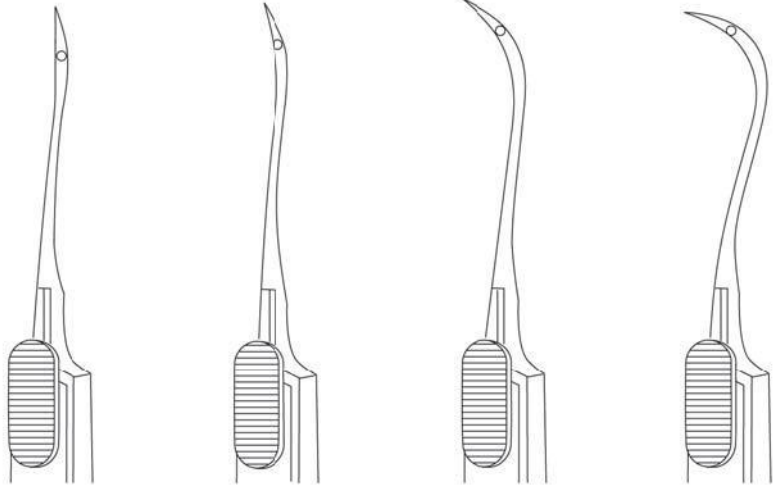

| | | | | |
|--------------|---------------------|---------------------|---------------------|---------------------|
| 15,0 cm, 6" | 11-27-215-01 | 11-27-215-02 | 11-27-215-03 | 11-27-215-04 |
| 19,0 cm, 7½" | 11-27-219-01 | 11-27-219-02 | 11-27-219-03 | 11-27-219-04 |



REVERDIN

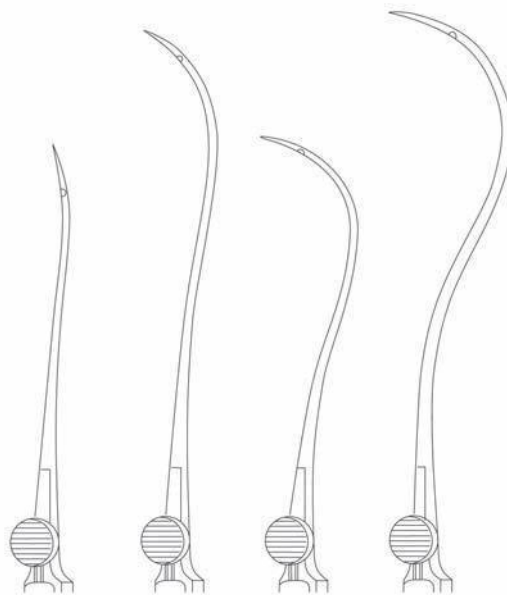

| | | | | |
|--------------|---------------------|---------------------|---------------------|---------------------|
| 21,0 cm, 8¼" | 11-27-221-01 | 11-27-221-02 | 11-27-221-03 | 11-27-221-04 |
| 23,0 cm, 9" | 11-27-223-01 | 11-27-223-02 | 11-27-223-03 | 11-27-223-04 |



scharf
 sharp
 pointu
 aguda
 острые

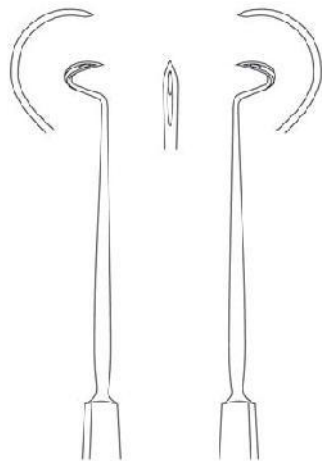

11-27-320-20

11-27-321-20

DESCHAMPS
 20,0 cm, 8"



scharf
 sharp
 pointu
 aguda
 острые

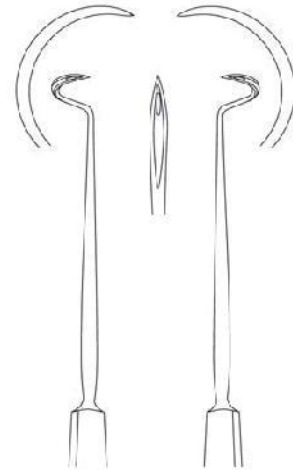

11-27-322-20

11-27-323-20

DESCHAMPS
 20,0 cm, 8"

11



stumpf
 blunt
 mousse
 tupo
 тупые

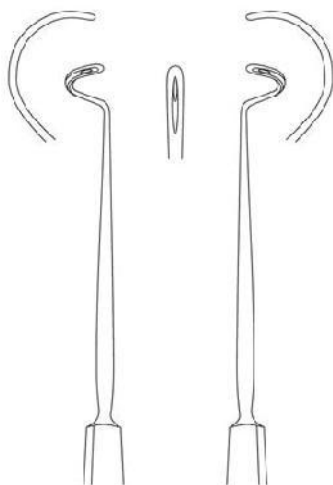

20,0 cm, 8 $\frac{3}{4}$ " 11-27-328-20 11-27-329-20
 22,5 cm, 8 $\frac{3}{4}$ " 11-27-328-22 11-27-329-22

DESCHAMPS



stumpf
 blunt
 mousse
 tupo
 тупые

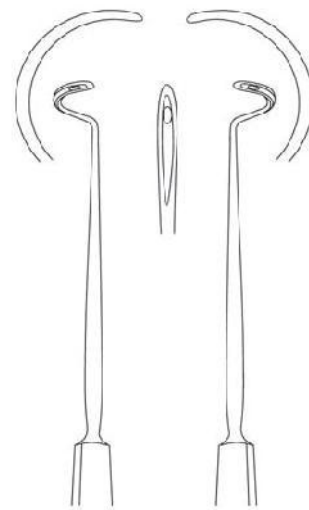

20,0 cm, 8 $\frac{3}{4}$ " 11-27-330-20 11-27-331-20
 22,5 cm, 8 $\frac{3}{4}$ " 11-27-330-22 11-27-331-22

DESCHAMPS



scharf
 sharp
 pointu
 aguda
 острые

21,0 cm, 8¼" 11-27-324-21 11-27-325-21
 27,0 cm, 10⅝" 11-27-324-27 11-27-325-27

DESCHAMPS



stumpf
 blunt
 mousse
 roma
 тупые

21,0 cm, 8¼" 11-27-332-21 11-27-333-21
 22,5 cm, 8¾" 11-27-332-22 11-27-333-22
 24,0 cm, 9½" 11-27-332-24 11-27-333-24
 27,0 cm, 10⅝" 11-27-332-27 11-27-333-27
 28,0 cm, 11" 11-27-332-28 11-27-333-28

DESCHAMPS



1/1

1/1

biegsam
 malleable
 malléable
 maleable
 гнущиеся

23,0 cm, 9"
 11-27-450-23



COOPER
 19,0 cm, 7½"
 11-27-451-19



COOPER
 20,0 cm, 8"
 11-27-451-20



SYME
 15,0 cm, 6"
 11-27-453-15



KOCHER
19,0 cm, 7½"



Fig. 1

11-27-452-01



Fig. 2

11-27-452-02



Fig. 3

11-27-452-03



BRUNNER
25,0 cm, 9¾"

11



BRUNNER
30,0 cm, 11¾"

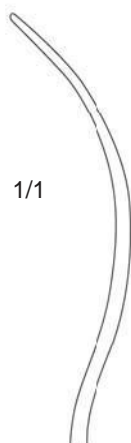

1/1

11-27-454-01



1/1

11-27-454-02



SCHMIEDEN
21,0 cm, 8¾"



YOUNG-HRYNTSCHAK
 24,0 cm, 9½"
 11-27-460-24



Fig. 1

11-27-460-01



Fig. 2

11-27-460-02

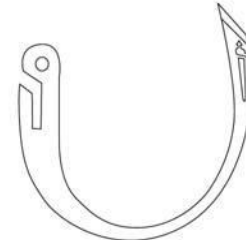

Fig. 3

11-27-460-03



DE LA ROZA
 12,0 cm, 4¾"
 11-27-467-01



DE LA ROZA
 12,0 cm, 4¾"
 11-27-467-02



JAKOBI
 14,0 cm, 5½"
 11-27-469-14



HESSEBERG
 15,0 cm, 6"
 11-27-468-15



KRONECKER
 13,0 cm, 5"
 11-27-470-01



KRONECKER
 13,0 cm, 5"
 11-27-470-02

Unterbindungsnadeln
 Ligature Needles
 Aiguilles a ligature
 Agujas para ligaduras
 Иглы лигатурные



TRELAT
 23,0 cm, 9"
 11-27-472-23



CLAUS
 23,0 cm, 9"
 11-27-473-23



HURD
 21,0 cm, 8¼"
 11-27-474-01



HURD
 21,0 cm, 8¼"
 11-27-474-02

11



NAGER
 24,0 cm, 9½"
 11-27-477-24



CLAUS-EICKEN
 23,0 cm, 9"
 11-27-481-23



FALK
 24,0 cm, 9½"
 11-27-480-01



FALK
 24,0 cm, 9½"
 11-27-480-02



BRUNNER
30,0 cm, 11¾"

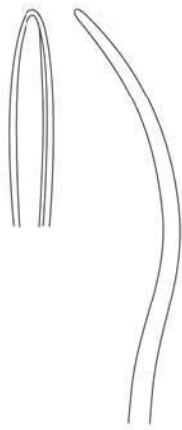

Fig. 1

11-27-500-01

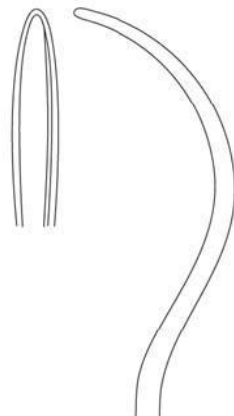

Fig. 2

11-27-500-02

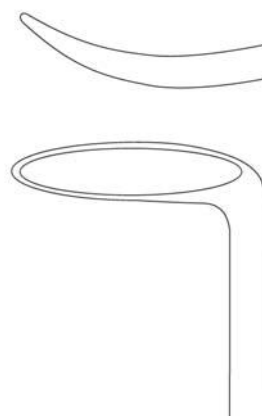

Fig. 3

11-27-500-03

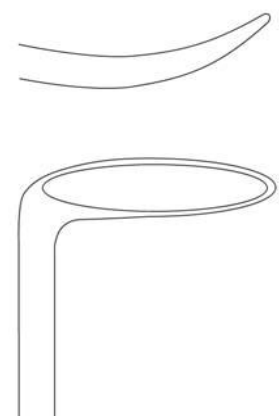

Fig. 4

11-27-500-04



PAYR
 22,0 cm, 8⁵/₁₆"
 11-27-502-22



PAYR
 22,0 cm, 8⁵/₁₆"
 11-27-503-22



mit Loch
 with hole
 avec perforateur
 con foro
 с отверстием

SCHMIEDEN-PAYR
 19,0 cm, 7¹/₂"
 11-27-506-19



ohne Loch
 without hole
 sans perforateur
 sin foro
 без отверстия

SCHMIEDEN
 19,0 cm, 7¹/₂"
 11-27-507-19

11



KÖNIG
 19,5 cm, 7³/₄"
 11-27-508-03



KÖNIG
 19,5 cm, 7³/₄"
 11-27-508-05



KÖNIG
 19,5 cm, 7³/₄"
 11-27-508-07



KIRSCHNER



25,5 cm, 10"
11-27-510-25



28,0 cm, 11"
11-27-510-28



BRUNNER-FERROZELL
 18,0 cm, 7" 11-27-521-18
 27,0 cm, 10⁵/₈" 11-27-521-27



KOCHER

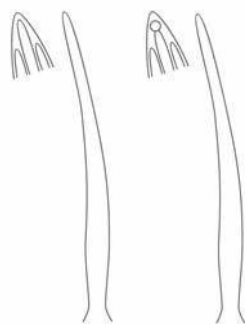

15,0 cm, 6" 11-27-513-15 11-27-514-15
 16,0 cm, 6¹/₄" 11-27-513-16 11-27-514-16



18,0 cm, 7" 11-27-515-18 11-27-516-18
 18,0 cm, 7"



MOD. WIEN
 23,5 cm, 9¼"
 11-27-532-23



BOZEMANN
 21,0 cm, 8¼"
 11-27-531-21



23,0 cm, 9"
 11-27-530-23



MICHEL
 12,0 cm, 4¾"
 11-27-550-12



COLLIN
 13,0 cm, 5"
 11-27-552-13



RICHTER-HEATH
 14,0 cm, 5½"
 11-27-553-14



WACHENFELDT
 12,5 cm, 5"
 11-27-555-01



HEGENBARTH
 12,5 cm, 5"
 11-27-556-12



MICHEL
 12,0 cm, 4¾"
 11-27-558-12



LANGE
 10,0 cm, 4"
 11-27-559-10



CHILDE
 18,0 cm, 7"
 11-27-560-01



CHILDE
 18,0 cm, 7"
 11-27-560-02

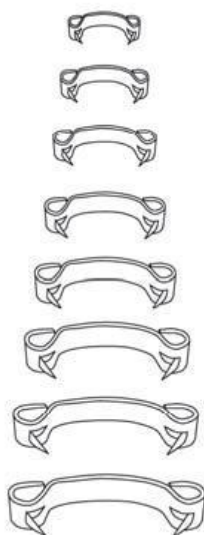

- 11-27-570-08 7,5 x 1,75 mm
- 11-27-570-11 11,0 x 2,0 mm
- 11-27-570-12 12,0 x 3,0 mm
- 11-27-570-14 14,0 x 3,0 mm
- 11-27-570-16 16,0 x 3,0 mm
- 11-27-570-18 18,0 x 3,0 mm
- 11-27-570-20 20,0 x 3,0 mm
- 11-27-570-22 22,0 x 3,0 mm



CLIP-SET
 11-27-558-00

bestehend aus, consisting of, consisten en,
 compuesto de, состоит из:

- 1 x **11-27-558-12**
- 1 x **11-27-550-12**
- 50 x **11-27-570-14**
- 1 x **11-27-590-01** (Etui)

**Wundhaken
Retractors
Ecarteurs
Separadores
Ранорасширители**





Fig. 1
 13-28-050-01



Fig. 2
 13-28-050-02

GILLIES
 18,0 cm, 7"



KILNER
 15,0 cm, 6"
 13-28-054-15



13,0 cm, 5" **13-28-060-13**
 18,0 cm, 7" **13-28-060-18**



13,0 cm, 5" **13-28-061-13**
 18,0 cm, 7" **13-28-061-18**

FRAZIER

scharf
 sharp
 pointu
 agudos
 острые

stumpf
 blunt
 mousse
 roma
 тупые



O'CONNOR
 16,0 cm, 6¼"
 13-28-074-16



Fig. 1
 13-28-058-01



Fig. 2
 13-28-058-02



Fig. 3
 13-28-058-03

KLEINERT-KUTZ
 16,0 cm, 6¼"



JOSEPH
 16,0 cm, 6¼"
 13-28-280-16

Schleimhauthäkchen
 Mucosa Hooklet
 Crochet pour la
 muqueuse
 Ganchito para mucosa
 Крючок для слизистой



Fig. 1
 13-28-078-01



Fig. 2
 13-28-078-02

GRAEFE
 16,0 cm, 6¼"



scharf
 sharp
 pointu
 agudos
 острые



Fig. 1
 13,0 cm, 5"
13-28-070-01



Fig. 2
 18,0 cm, 7"
13-28-070-02

stumpf
 blunt
 mousse
 тупо
 тупые



Fig. 3
 13,0 cm, 5"
13-28-070-03



Fig. 4
 18,0 cm, 7"
13-28-070-04



Fig. 1
13-28-080-01



Fig. 2
13-28-080-02

GUTHRIE
 16,0 cm, 6¼"



Fig. 1
13-28-086-02



Fig. 2
13-28-086-05



Fig. 3
13-28-086-07



Fig. 4
13-28-086-10

Schleimhauthäkchen
Mucosa Hooklet
Crochet pour la
muqueuse
Ganchito para mucosa
Крючок для слизистой

JOSEPH
 16,0 cm, 6¼"



KNAPP
13,0 cm, 5"

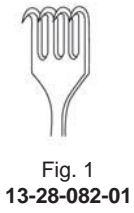

scharf
sharp
pointu
agudos
острые



stumpf
blunt
mousse
romo
тупые



16,0 cm, 6¼"



13-28-088-02



13-28-088-03



13-28-088-04



13-28-089-02



13-28-089-03

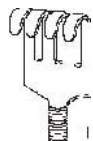

13-28-089-04

flexibel · flexible · malléable · flexibles · гибкие



16,0 cm, 6¼"



13-28-101-01



13-28-101-02



13-28-101-03



13-28-101-04

scharf
sharp
pointu
agudos
острые

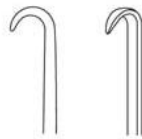

13-28-103-01



13-28-103-02



13-28-103-03



13-28-103-04

halbscharf
half-sharp
semi-pointu
semi-agudos
полуострые



13-28-102-01

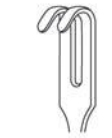

13-28-102-02



13-28-102-03



13-28-102-04

stumpf
blunt
mousse
romo
тупые



16,0 cm, 6¼"

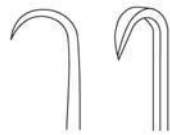

13-28-111-01



13-28-111-02



13-28-111-03

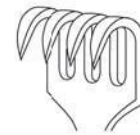

13-28-111-04

scharf
 sharp
 pointu
 agudos
 острые

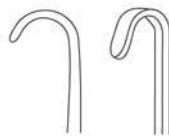

13-28-112-01



13-28-112-02



13-28-112-03

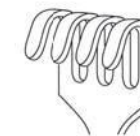

13-28-112-04

stumpf
 blunt
 mousse
 romo
 тупые



CUSHING
 19,0 cm, 7½"



Fig. 1
 13-28-140-01



Fig. 2
 13-28-140-02



LANGENBECK-GREEN
 16,0 cm, 6¼"



16 x 6 mm
 13-28-162-01



24 x 6 mm
 13-28-162-02



MEYERDING
 18,0 cm, 7"



18 x 7 mm
 13-28-150-01



16 x 5 mm
 13-28-150-02



7 x 4 mm
 13-28-150-03



10 x 3 mm
 13-28-150-04



7 x 4 mm
 13-28-150-05



4 x 10 mm
 13-28-150-06



16,0 cm, 6 1/4"



14 x 8 mm
 13-28-166-16



SENN-GREEN
 15,0 cm, 6"



10 x 6 mm
 13-28-160-10



20 x 6 mm
 13-28-160-20



MINI-LANGENBECK
 16,0 cm, 6 1/4"



10 x 6 mm
 13-28-164-01

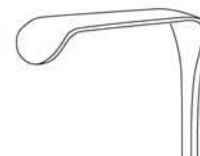

17 x 5 mm
 13-28-164-02

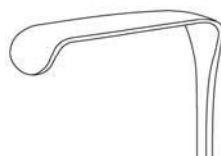

20 x 6 mm
 13-28-164-03

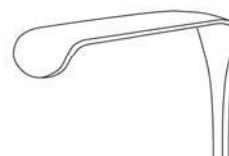

22 x 8 mm
 13-28-164-04

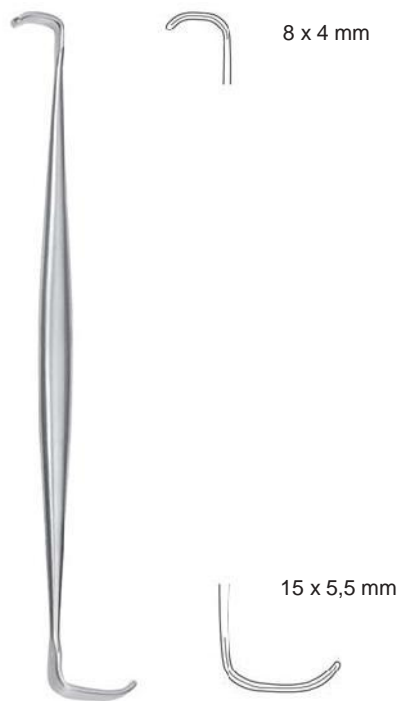

RAGNELL-DAVIS
 14,0 cm, 5½"
 13-28-170-14



RAGNELL
 15,0 cm, 6"
 13-28-174-15

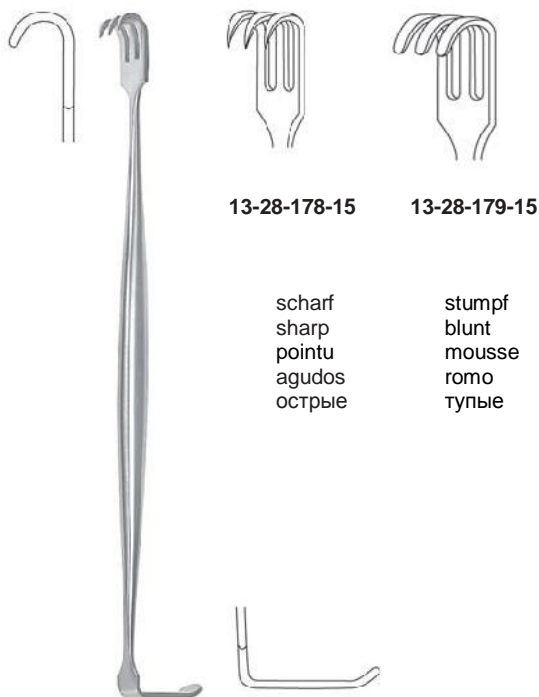

BABY SENN-MILLER
 15,0 cm, 6"

13-28-178-15

13-28-179-15

scharf
 sharp
 pointu
 agudos
 острые

stumpf
 blunt
 mousse
 romo
 тупые

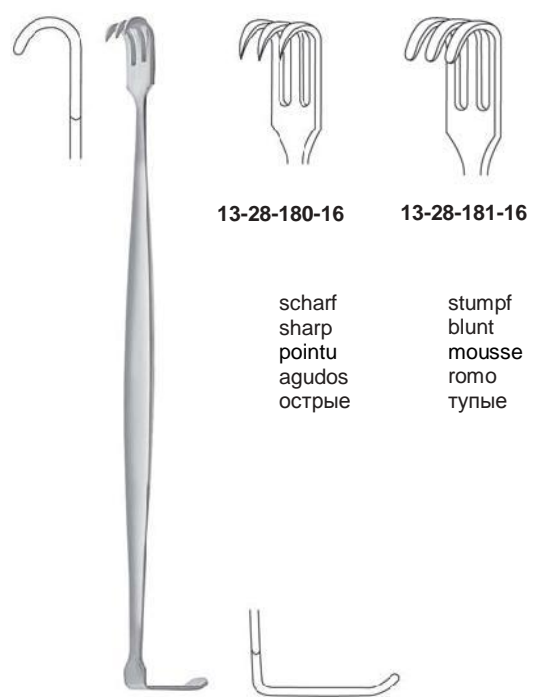

SENN-MILLER
 16,0 cm, 6¼"

13-28-180-16

13-28-181-16

scharf
 sharp
 pointu
 agudos
 острые

stumpf
 blunt
 mousse
 romo
 тупые

Sattelhäkchen, Wundhäkchen
 Saddle Hooks, Hooklets
 Ecarteurs sous forme de selle, Crochets
 Ganchos en forma de selle, Ganchitos
 Крючки для век, ранорасширители-крючочки

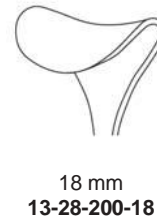
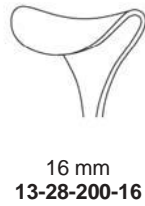
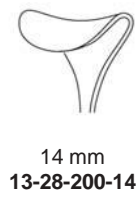

DESMARRES
13,0 cm, 5

13

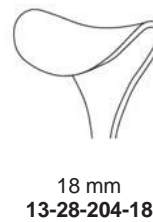
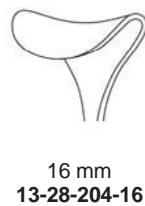
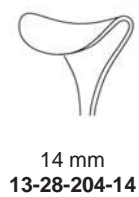

DESMARRES
16,0 cm, 6¼"



CUSHING
20,0 cm, 8"



8 mm
13-28-210-08



10 mm
13-28-210-10



12 mm
13-28-210-12



14 mm
13-28-210-14

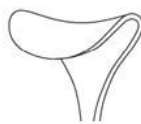

16 mm
13-28-210-16

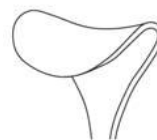

18 mm
13-28-210-18



CUSHING
24,0 cm, 9½"



8 mm
13-28-212-08



10 mm
13-28-212-10



12 mm
13-28-212-12



14 mm
13-28-212-14

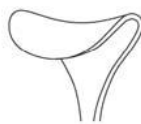

16 mm
13-28-212-16



18 mm
13-28-212-18

Sattelhäkchen
 Saddle Hooks
 Ecarteurs sous forme de selle
 Ganchos en forma de selle
 Крючки для век



GIL-VERNET
 24,0 cm, 9½"



8 mm
 13-28-220-08



11 mm
 13-28-220-11



13 mm
 13-28-220-13



15 mm
 13-28-220-15



17 mm
 13-28-220-17



20 mm
 13-28-220-20



23 mm
 13-28-220-23



GIL-VERNET
 24,0 cm, 9½"



8 mm
 13-28-230-08



11 mm
 13-28-230-11



13 mm
 13-28-230-13



15 mm
 13-28-230-15



17 mm
 13-28-230-17



20 mm
 13-28-230-20



23 mm
 13-28-230-23



ROUX

Fig. 1 24 x 20 mm
 Fig. 2 29 x 26 mm
 Fig. 3 33 x 29 mm
 Fig. 4 29 x 24 mm

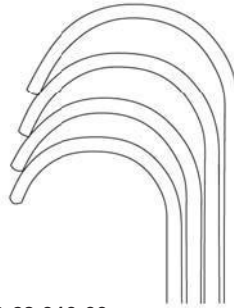

13-28-310-00
 Satz, Fig. 1-3
 Set, fig. 1-3
 Set, figure 1-3
 Juego, fig. 1-3
 Набор фиг. 1-3

Fig. 1 30 x 28 mm
 Fig. 2 36 x 36 mm
 Fig. 3 38 x 43 mm
 Fig. 4 45 x 28 mm

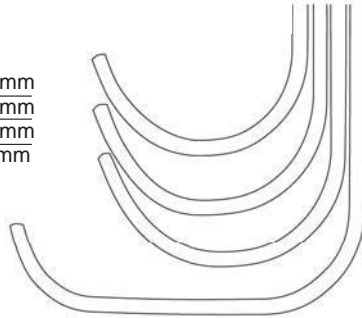
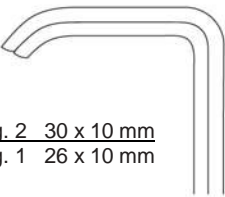

Fig. 1-3 17,0 cm, 6³/₄" **13-28-310-00**
 Fig. 1 14,0 cm, 5¹/₂" **13-28-310-01**
 Fig. 2 15,0 cm, 6" **13-28-310-02**
 Fig. 3 17,0 cm, 6³/₄" **13-28-310-03**
 Fig. 4 18,0 cm, 7" **13-28-310-04**



FARABEUFF
 12,0 cm, 4³/₄"

Fig. 2 30 x 10 mm
 Fig. 1 26 x 10 mm



13-28-300-12
 Satz, Fig.1-2
 Set, fig.1-2
 Set, figure 1-2
 Juego, fig.1-2
 Набор фиг.1-2

Fig. 1 30 x 13 mm
 Fig. 2 34 x 13 mm

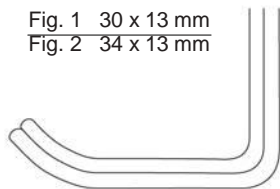

FARABEUFF
 15,0 cm, 5³/₄"

Fig. 2 23 x 16 mm
 Fig. 1 27 x 16 mm

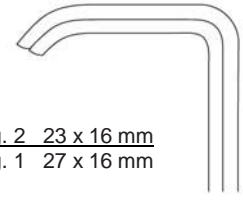

13-28-302-15
 Satz, Fig.1-2
 Set, fig.1-2
 Set, figure 1-2
 Juego, fig.1-2
 Набор фиг.1-2

Fig. 1 26 x 16 mm
 Fig. 2 30 x 16 mm

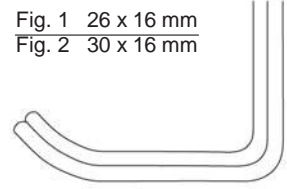



MINI-ROUX
15,0 cm, 6"
13-28-340-15

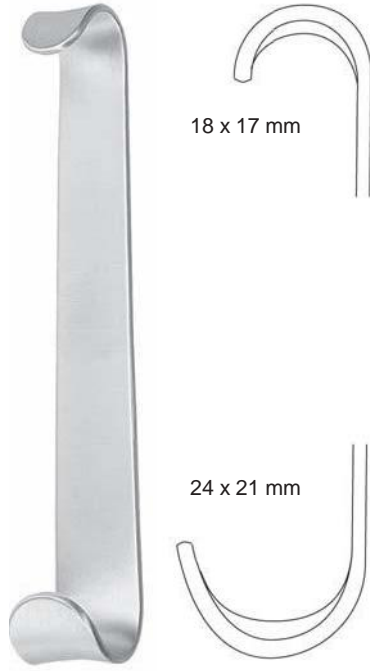

BABY-ROUX
13,0 cm, 5"
13-28-342-13

18 x 17 mm

24 x 21 mm



PARKER
13,5 cm, 5 3/8"

Fig. 2 22 x 15 mm
Fig. 1 19 x 15 mm

13-28-350-13
Satz, Fig. 1-2
Set, fig. 1-2
Set, figure 1-2
Juego, fig. 1-2
Набор фиг. 1-2

Fig. 1 19 x 15 mm
Fig. 2 22 x 15 mm



PARKER
18,0 cm, 7"

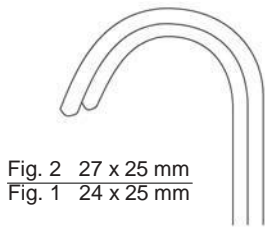
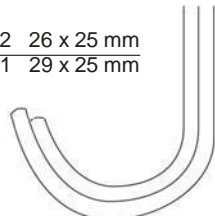

Fig. 2 27 x 25 mm
Fig. 1 24 x 25 mm

13-28-350-18
Satz, Fig. 1-2
Set, fig. 1-2
Set, figure 1-2
Juego, fig. 1-2
Набор фиг. 1-2

Fig. 2 26 x 25 mm
Fig. 1 29 x 25 mm



MATHIEU
20,0 cm, 8"

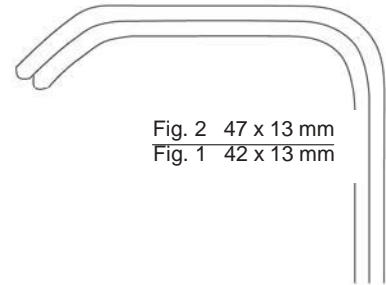
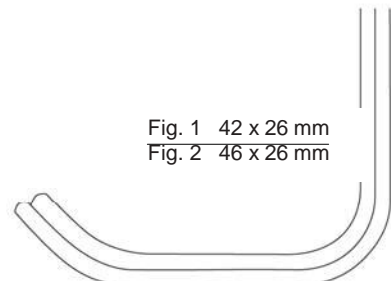

Fig. 2 47 x 13 mm
Fig. 1 42 x 13 mm

13-28-380-00
Satz, Fig. 1-2
Set, fig. 1-2
Set, figure 1-2
Juego, fig. 1-2
Набор фиг. 1-2

Fig. 1 42 x 26 mm
Fig. 2 46 x 26 mm





GOELET
 19,0 cm, 7½"
13-28-396-19

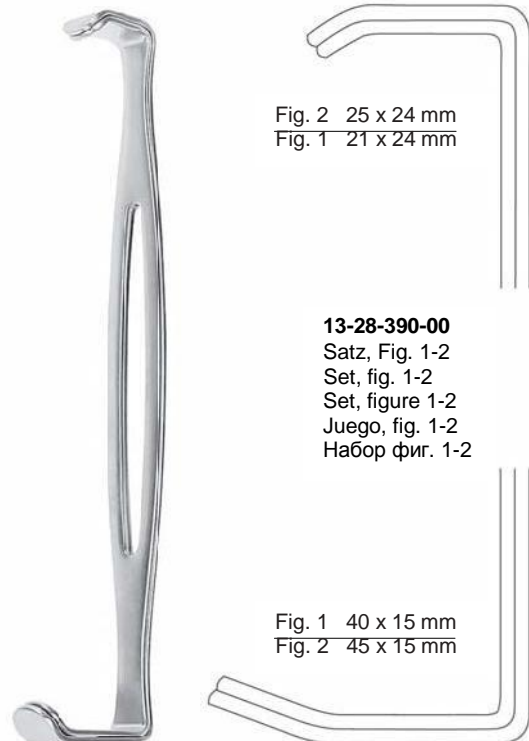

PARKER-LANGENBECK
 21,0 cm, 8¼"

Fig. 2 25 x 24 mm
 Fig. 1 21 x 24 mm

13-28-390-00
 Satz, Fig. 1-2
 Set, fig. 1-2
 Set, figure 1-2
 Juego, fig. 1-2
 Набор фиг. 1-2

Fig. 1 40 x 15 mm
 Fig. 2 45 x 15 mm

Fig. 1 **13-28-390-01**
 Fig. 2 **13-28-390-02**



CANNY RYAL

| | | |
|-------|--------------|---------------------|
| 16 mm | 19,0 cm, 7½" | 13-28-370-16 |
| 20 mm | 19,0 cm, 7½" | 13-28-370-20 |
| 25 mm | 20,0 cm, 8" | 13-28-370-25 |

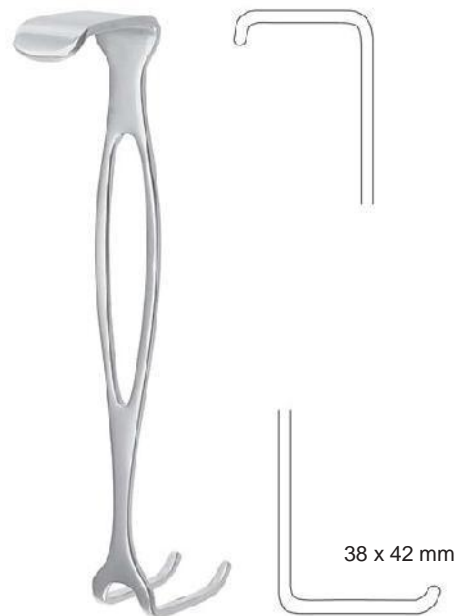

CZERNY
 17,5 cm, 7"
13-28-360-00

Wundhaken
Retractors
Ecarteurs
Separadores
Ранорасширители-крючки

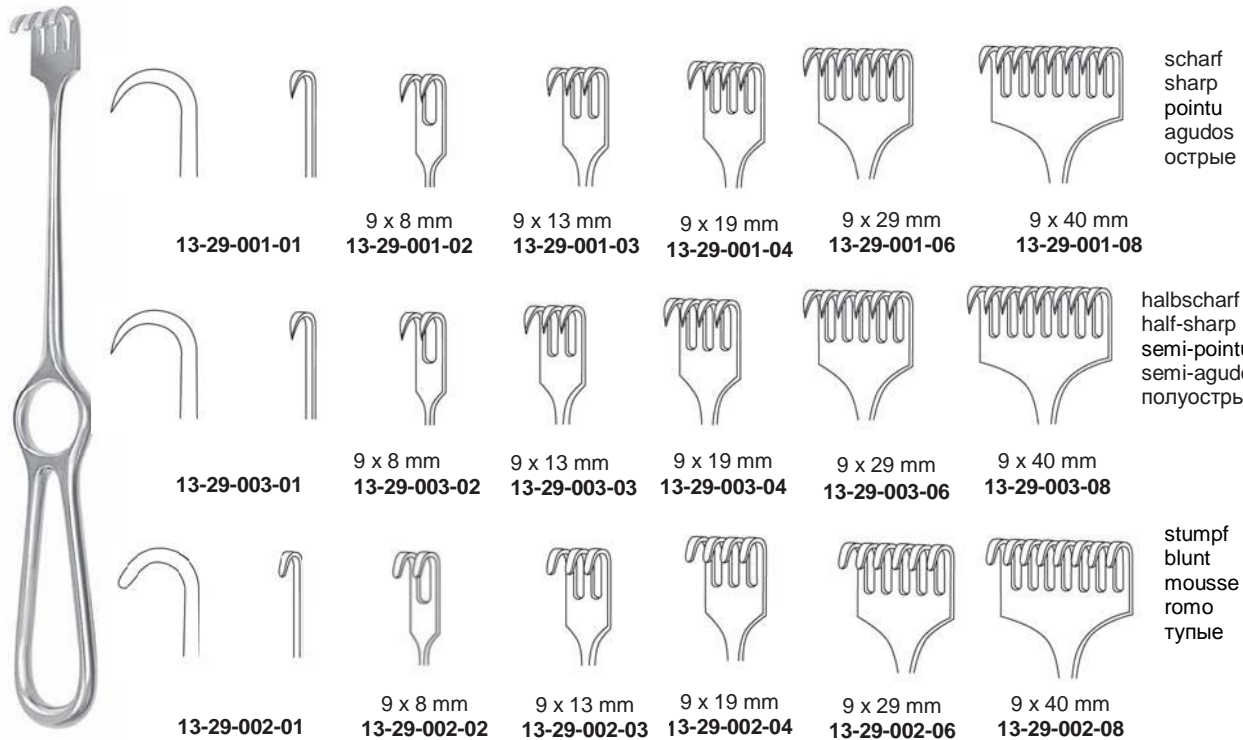

VOLKMANN
21,5 cm, 8½"

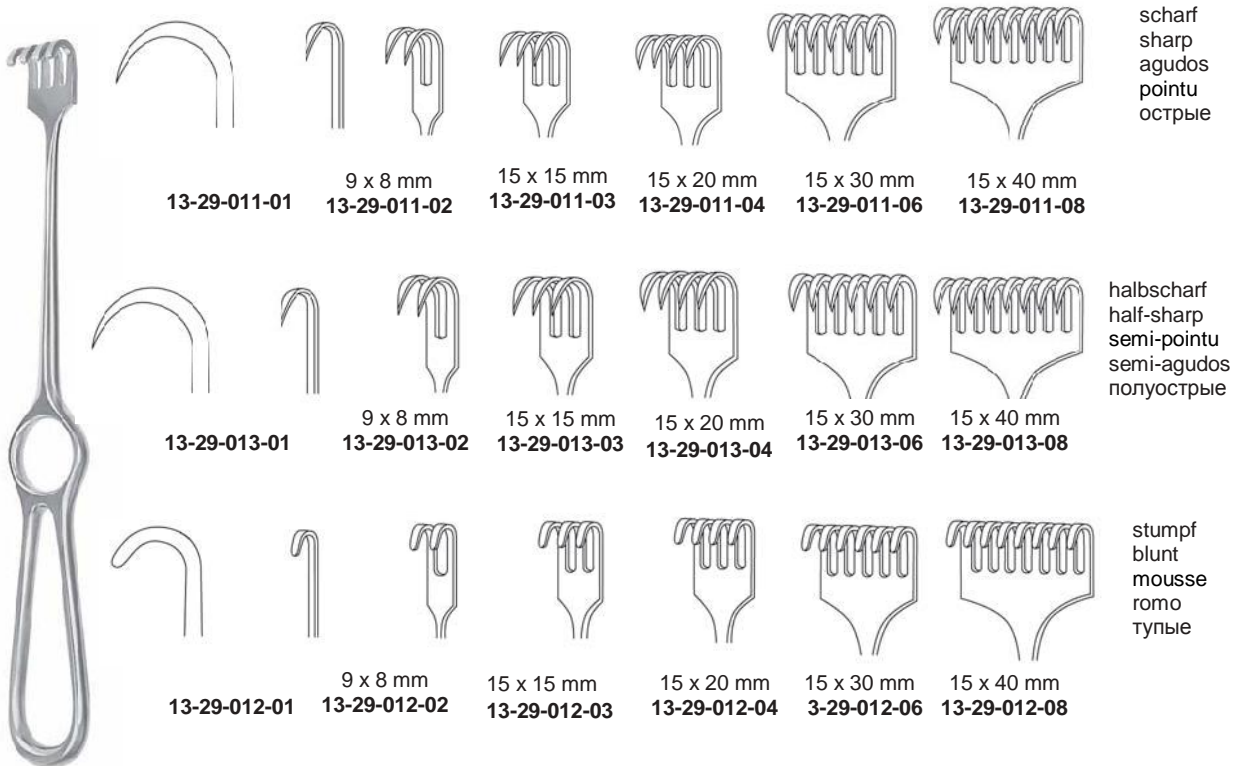

KOCHER
22,0 cm, 8⅝"



KOERTE
 24,0 cm, 9½"



26 x 40 mm
13-29-021-24

stumpf
 blunt
 mousse
 romo
 тупые



26 x 40 mm
13-29-022-24

scharf
 sharp
 pointu
 agudos
 острые



LANGENBECK
 21,0 cm, 8¼"

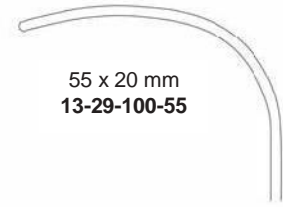

55 x 20 mm
13-29-100-55

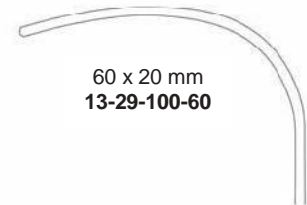

60 x 20 mm
13-29-100-60



63 x 20 mm
13-29-100-63



KOCHER
 22,0 cm, 8⅝"

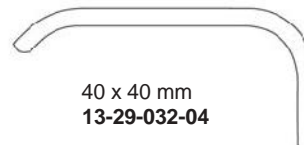

40 x 40 mm
13-29-032-04

4 Zähne
 4 teeth
 4 griffes
 4 dientes
 4 зубца

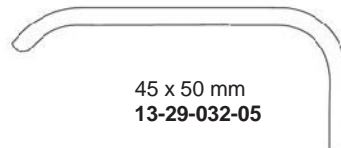

45 x 50 mm
13-29-032-05

5 Zähne
 5 teeth
 5 griffes
 5 dientes
 5 зубцов

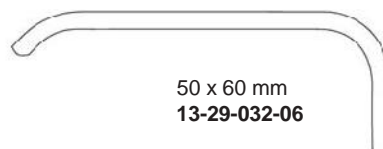

50 x 60 mm
13-29-032-06

6 Zähne
 6 teeth
 6 griffes
 6 dientes
 6 зубцов

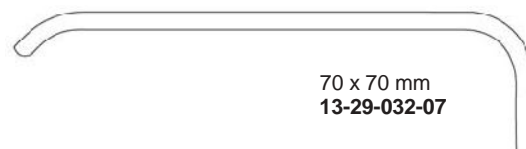

70 x 70 mm
13-29-032-07

6 Zähne
 6 teeth
 6 griffes
 6 dientes
 6 зубцов



30 x 11 mm
13-29-110-30



30 x 14 mm
13-29-110-31



30 x 16 mm
13-29-110-32



33 x 14 mm
13-29-110-33



40 x 11 mm
13-29-110-40

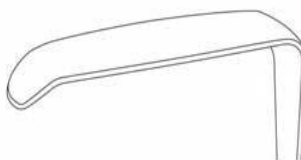

42 x 13 mm
13-29-110-42

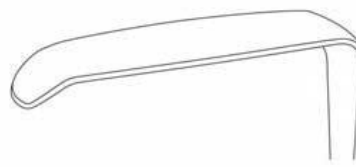

50 x 11 mm
13-29-110-50

LANGENBECK
22,0 cm, 8⁵/₈"



30 x 11 mm
13-29-120-30



30 x 14 mm
13-29-120-31



30 x 16 mm
13-29-120-32



33 x 14 mm
13-29-120-33



40 x 11 mm
13-29-120-40

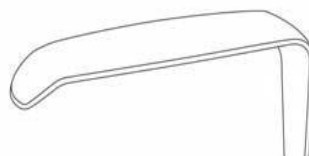

42 x 13 mm
13-29-120-42

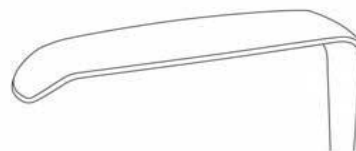











50 x 11 mm
13-29-120-50

LANGENBECK
22,0 cm, 8⁵/₈"



KOCHER-LANGENBECK
 21,5 cm, 8½"

| | |
|--|-----------------------------------|
|  | 25 x 6 mm 13-29-130-25 |
|  | 25 x 8 mm 13-29-130-26 |
|  | 35 x 8 mm 13-29-130-35 |
|  | 35 x 11 mm 13-29-130-36 |
|  | 35 x 15 mm 13-29-130-37 |
|  | 40 x 11 mm 13-29-130-40 |
|  | 55 x 11 mm 13-29-130-55 |
|  | 70 x 14 mm 13-29-130-70 |
|  | 80 x 12 mm 13-29-130-80 |
|  | 80 x 16 mm 13-29-130-85 |

Wundhaken
Retractors
Ecarteurs
Separadores
Ретракторы



KOCHER
23,0 cm, 9"

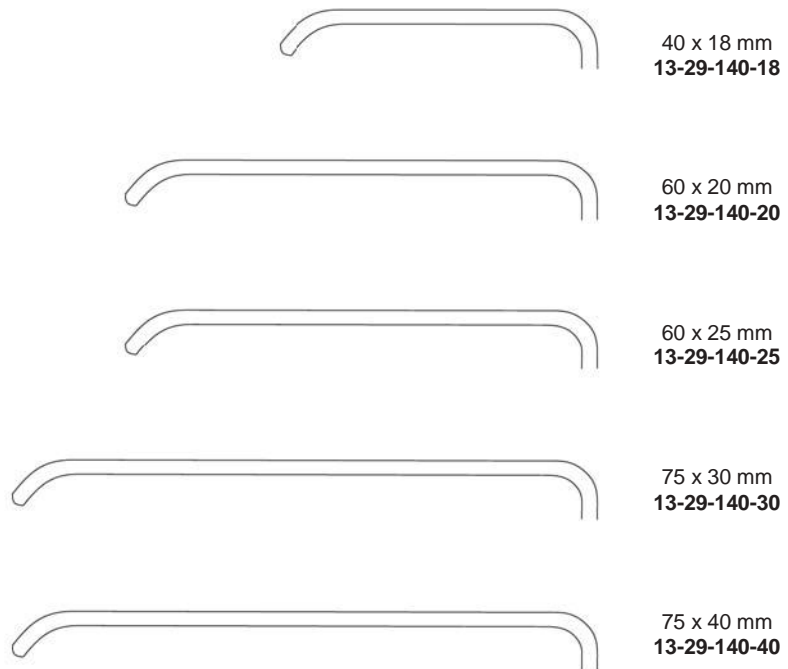

SAUERBRUCH
22,5 cm, 8¾"

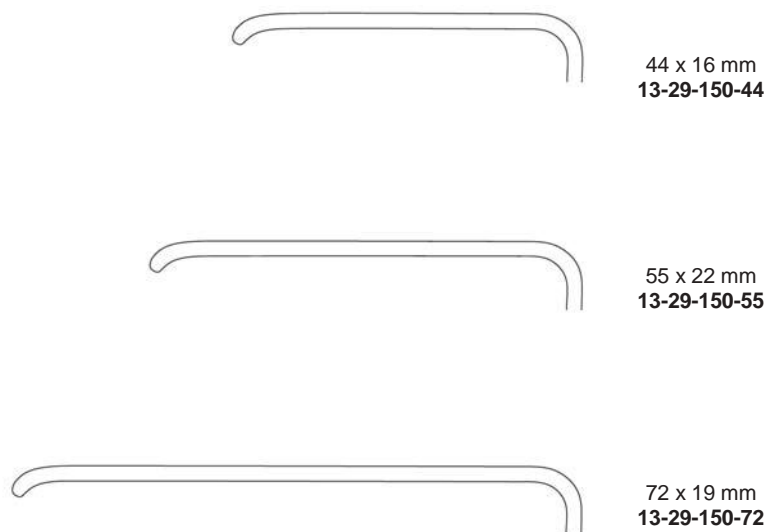



MIDDELDORPF



21,5 cm, 8½" 14 x 17 mm
13-29-180-01



22,0 cm, 8¾" 20 x 22 mm
13-29-180-02



23,5 cm, 9¼" 26 x 30 mm
13-29-180-03



MIDDELDORPF



21,5 cm, 8½" 14 x 17 mm
13-29-182-01



22,0 cm, 8¾" 20 x 22 mm
13-29-182-02



23,5 cm, 9¼" 26 x 30 mm
13-29-182-03



RICHARDSON (KELLY)
Loop Handle



28 x 20 mm
24,0 cm, 9½"
13-29-210-01

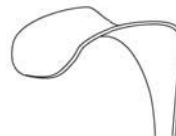

30 x 28 mm
24,0 cm, 9½"
13-29-210-02



38 x 37 mm
24,0 cm, 9½"
13-29-212-03

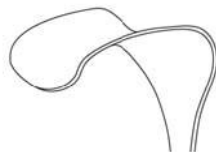

52 x 22 mm
24,0 cm, 9½"
13-29-210-04

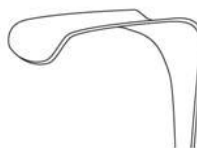

50 x 40 mm
26,0 cm, 10¼"
13-29-210-05

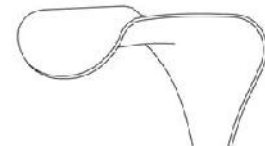

65 x 50 mm
26,0 cm 10¼"
13-29-210-06



65 x 75 mm
26,0 cm 10¼"
13-29-210-07

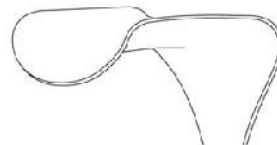

70 x 65 mm
26,0 cm 10¼"
13-29-210-08



90 x 76 mm
26,0 cm 10¼"
13-29-210-09

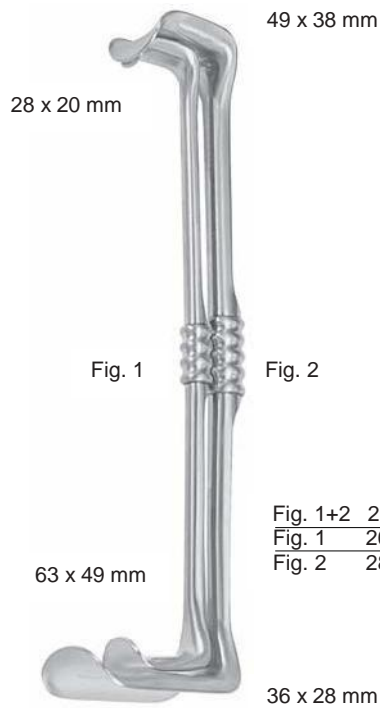

| | | |
|----------|-----------------------------|---------------------|
| Fig. 1+2 | 28,0 cm, 11" | 13-28-200-00 |
| Fig. 1 | 26,0 cm, 10 $\frac{1}{4}$ " | 13-28-200-01 |
| Fig. 2 | 28,0 cm, 11" | 13-28-200-02 |

RICHARDSON-EASTMAN

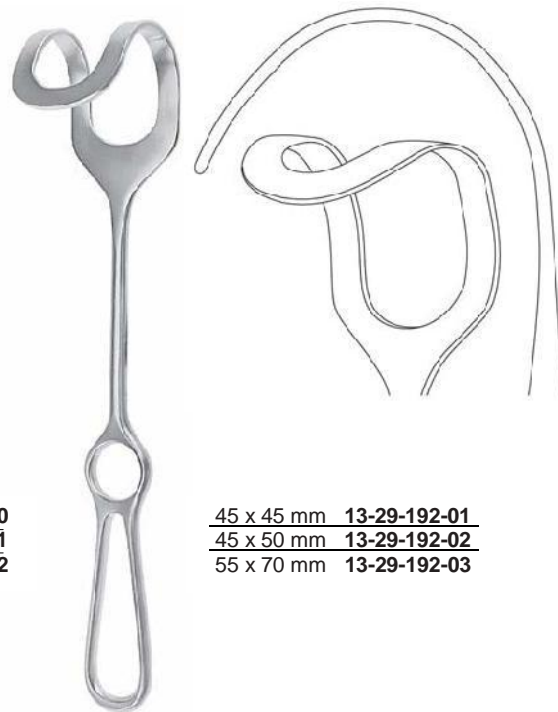

| | |
|------------|---------------------|
| 45 x 45 mm | 13-29-192-01 |
| 45 x 50 mm | 13-29-192-02 |
| 55 x 70 mm | 13-29-192-03 |

MIDDELDORPF
25,5 cm, 10"



| | |
|------------|---------------------|
| 45 x 40 mm | 13-29-240-40 |
| 45 x 50 mm | 13-29-240-50 |
| 45 x 60 mm | 13-29-240-60 |
| 55 x 75 mm | 13-29-240-75 |
| 65 x 85 mm | 13-29-240-85 |

FRITSCH
24,0 cm, 9 $\frac{1}{2}$ "



| | | |
|-----------------------------|------------|---------------------|
| 25,0 cm, 10" | 50 x 85 mm | 13-29-230-50 |
| 26,0 cm, 10 $\frac{1}{4}$ " | 78 x 82 mm | 13-29-230-51 |

DOYEN



DOYEN-STILLE
 22,0 cm, 8 $\frac{5}{8}$ "

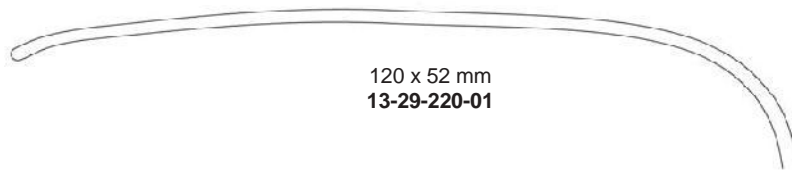

120 x 52 mm
13-29-220-01

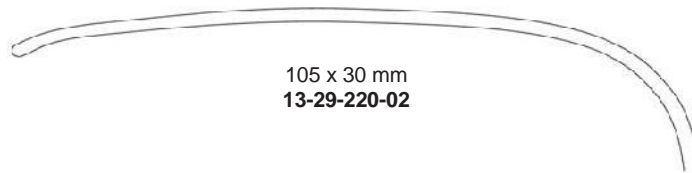

105 x 30 mm
13-29-220-02

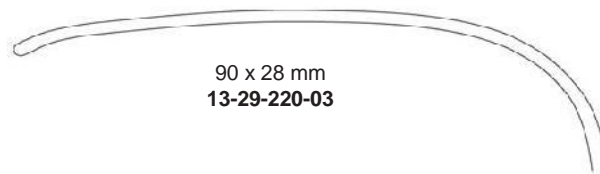

90 x 28 mm
13-29-220-03

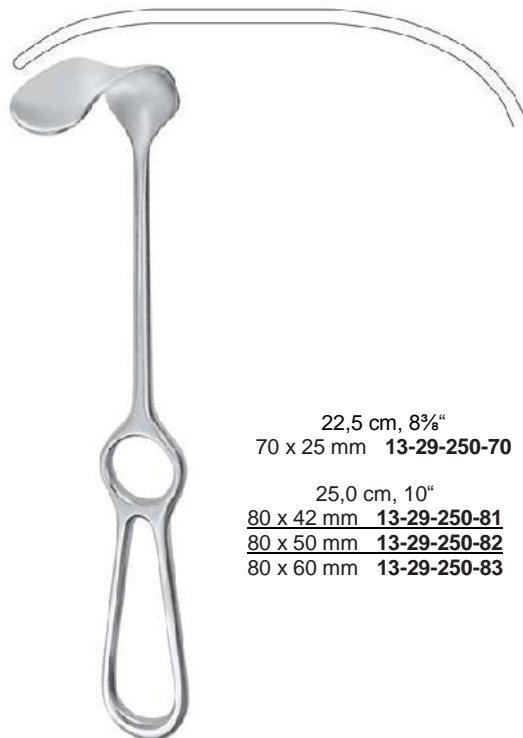

KOCHER

22,5 cm, 8 $\frac{3}{8}$ "
 70 x 25 mm **13-29-250-70**

25,0 cm, 10"
 80 x 42 mm **13-29-250-81**
 80 x 50 mm **13-29-250-82**
 80 x 60 mm **13-29-250-83**



LAHEY
 19,0 cm, 7 $\frac{1}{2}$ "
13-61-160-19

28 x 6 mm



12 x 14 mm

LITTLE
20,0 cm, 8"
1329-164-20



115 x 22 mm **13-29-260-01**
115 x 27 mm **13-29-260-02**

SIMON
28,0 cm, 11"



160 x 38 mm **13-29-280-61**
160 x 57 mm **13-29-280-62**
190 x 38 mm **13-29-280-91**
190 x 57 mm **13-29-280-92**

KELLY
27,0 cm, 10½"



185 x 35 mm **13-29-274-01**
 120 x 50 mm **13-29-274-02**
 155 x 50 mm **13-29-274-03**

MIKULICZ
 26,0 cm, 10¼"

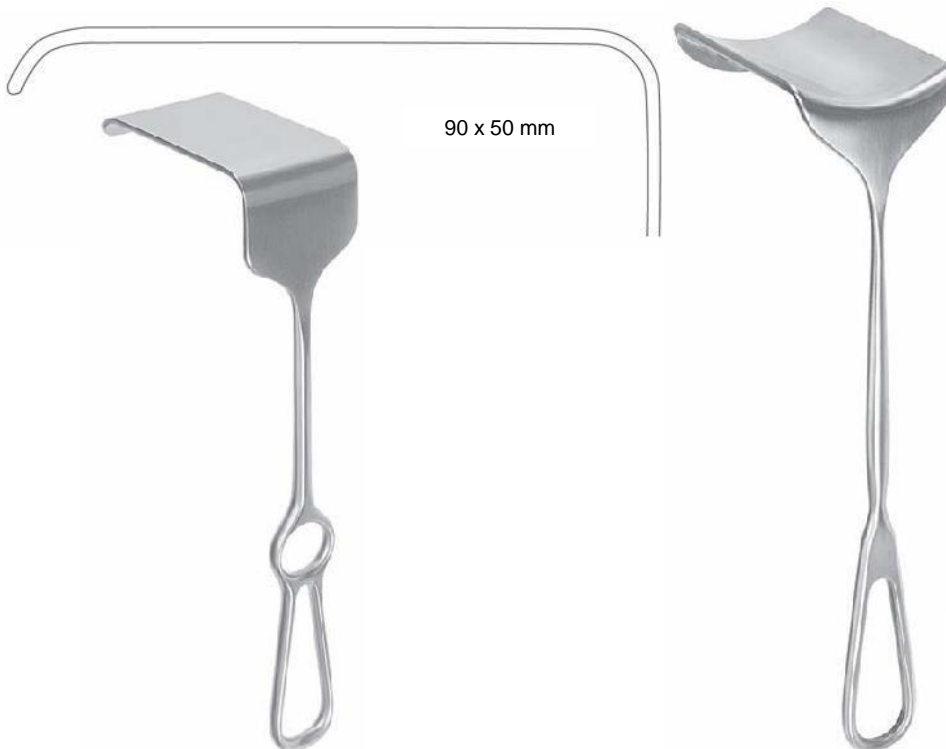

90 x 50 mm

MIKULICZ
 26,0 cm, 10¼"
13-29-272-90

70 x 38 mm **13-29-290-38**
 70 x 50 mm **13-29-290-50**
 70 x 65 mm **13-29-290-65**

MORRIS
 24,5 cm, 9¾"

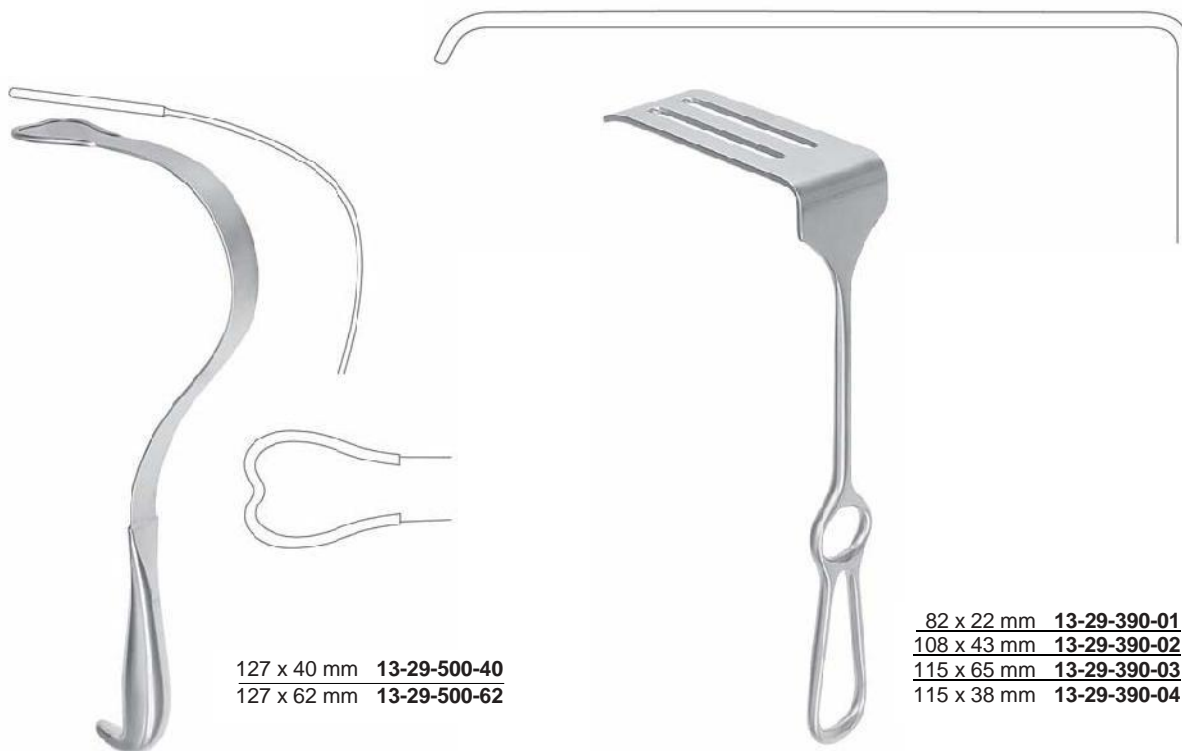

127 x 40 mm **13-29-500-40**
 127 x 62 mm **13-29-500-62**

82 x 22 mm **13-29-390-01**
108 x 43 mm **13-29-390-02**
115 x 65 mm **13-29-390-03**
 115 x 38 mm **13-29-390-04**

HARRINGTON
 32,0 cm, 12½"

CORYKKOS
 24,0 cm, 9½"

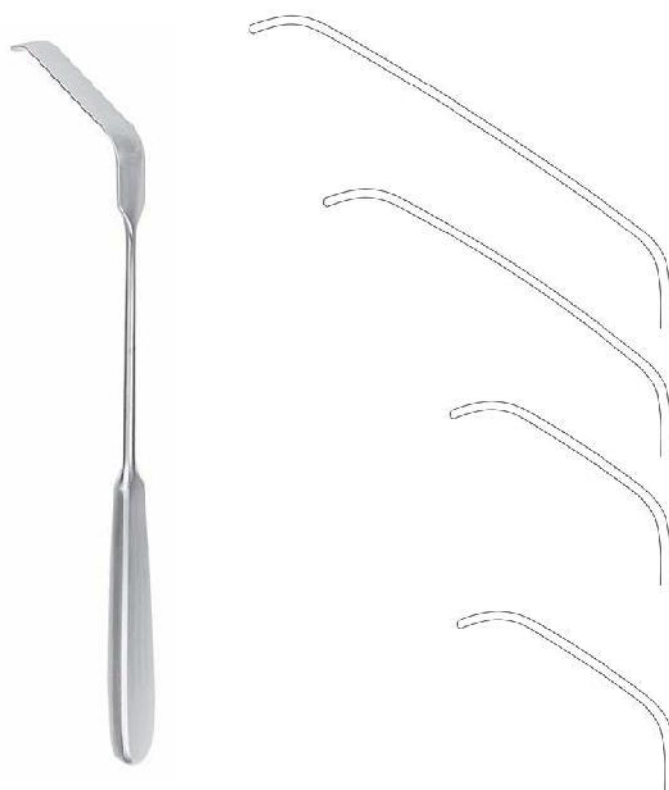

29,0 cm, 11¼", 120 x 12 mm
13-29-320-28

25,0 cm, 9¾", 75 x 12 mm
13-29-320-25

26,0 cm, 10¼", 60 x 12 mm
13-29-320-26

27,5 cm, 10¾", 35 x 8 mm
13-29-320-27

ZENKER



MEYERDING
22,5 cm, 8¾"

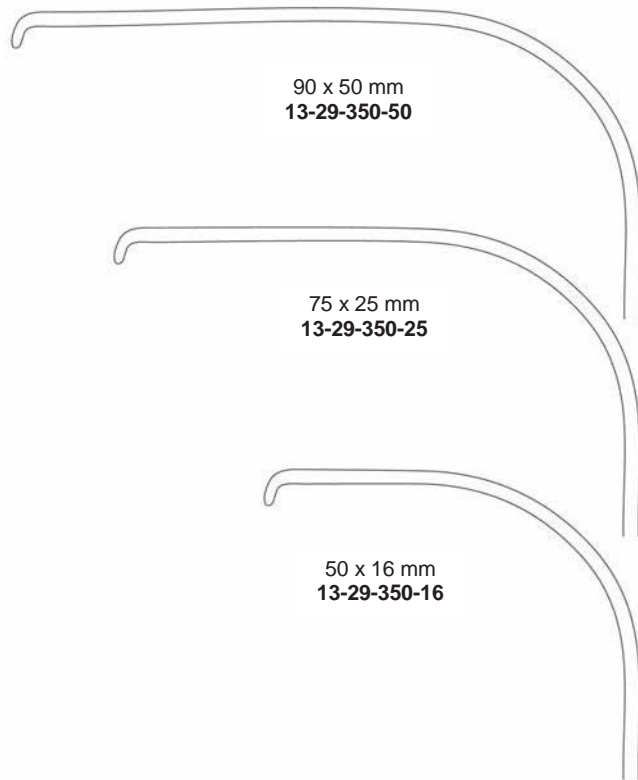

90 x 50 mm
13-29-350-50

75 x 25 mm
13-29-350-25

50 x 16 mm
13-29-350-16



BRUNNER
25,0 cm, 10"

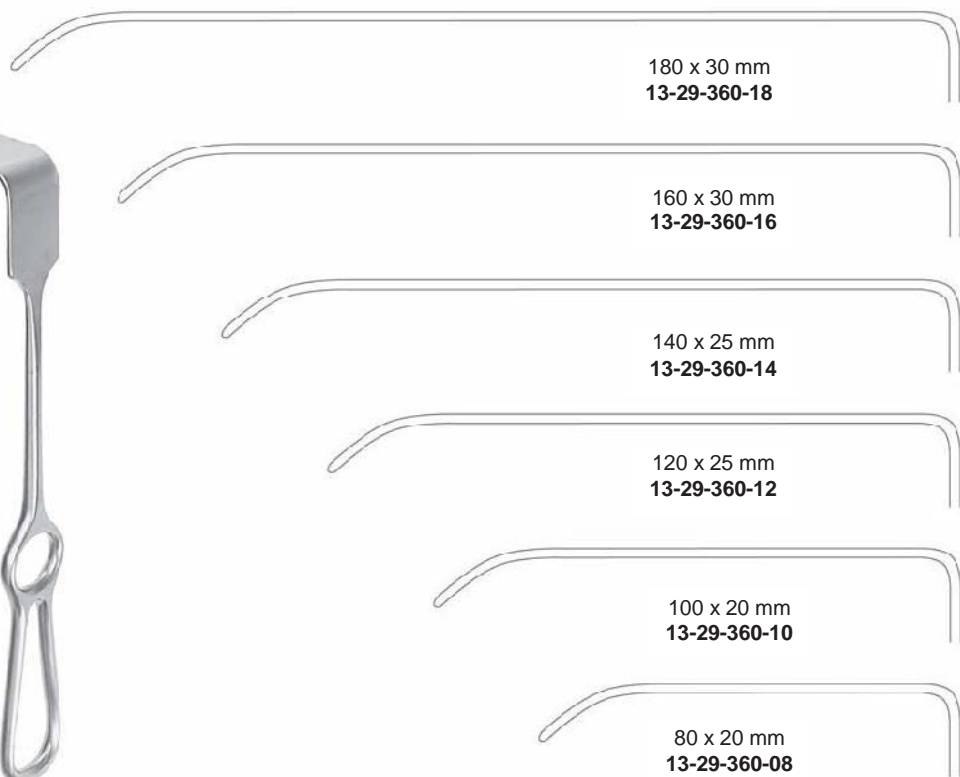

180 x 30 mm
13-29-360-18

160 x 30 mm
13-29-360-16

140 x 25 mm
13-29-360-14

120 x 25 mm
13-29-360-12

100 x 20 mm
13-29-360-10

80 x 20 mm
13-29-360-08



DEAVER
18,0 cm, 7"
13-29-602-19



DEAVER
21,5 cm, 8½"
13-29-602-22



DEAVER
23,0 cm, 9"
13-29-602-25



25 mm

DEAVER
30,0 cm, 11 $\frac{3}{4}$ "
13-29-604-30



25 mm

DEAVER
33,0 cm, 13"
13-29-604-33



25 mm

DEAVER
36,0 cm, 14 $\frac{1}{8}$ "
13-29-604-36



38 mm

DEAVER
30,0 cm, 11 $\frac{3}{4}$ "
13-29-610-38



50 mm

DEAVER
30,0 cm, 11 $\frac{3}{4}$ "
13-29-610-50



75 mm

DEAVER
30,0 cm, 11 $\frac{3}{4}$ "
13-29-610-75



| | |
|--------|--------------|
| 25 mm | 13-29-600-25 |
| 38 mm | 13-29-600-38 |
| 50 mm | 13-29-600-50 |
| 75 mm | 13-29-600-75 |
| 100 mm | 13-29-600-76 |

DEAVER GRIP
30,0 cm, 11¾"



ALLISON

| | | |
|-------|---------------|--------------|
| 40 mm | 30,0 cm, 11¾" | 13-29-700-30 |
| 54 mm | 32,0 cm, 12½" | 13-29-700-32 |



DAVIDSON

| | | |
|------------|--------------|--------------|
| 75 x 50 mm | 16,0 cm, 6¼" | 13-29-710-50 |
| 75 x 90 mm | 16,0 cm, 6¼" | 13-29-710-90 |



ST. MARKS

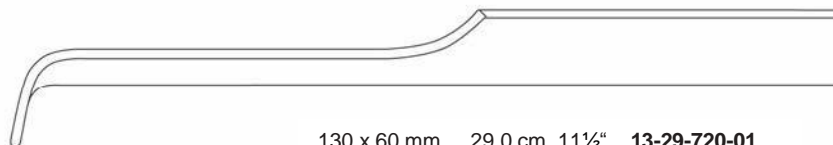

| | | |
|-------------|---------------|--------------|
| 130 x 60 mm | 29,0 cm, 11½" | 13-29-720-01 |
| 180 x 60 mm | 33,0 cm, 13" | 13-29-720-02 |







33,0 cm, 13" 180 x 60 mm 13-29-721-02

Wundspreizer
Self-Retaining Retractors
Ecarteurs autostatiques
Separadores con retenida automática
Самоудерживающиеся ранорасширители

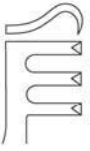
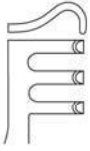
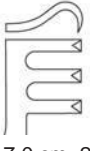
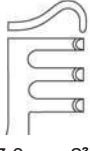

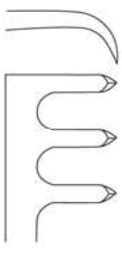
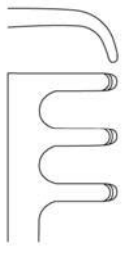
Wundspreizer
 Self-Retaining Retractors
 Ecarteurs autostatiques
 Separadores con retenida automática
 Самоудерживающиеся ранорасширители

| | | | | | |
|--|---|---|--|---|---|
| |  |  | | | |
| | 5,0 cm, 2" 15-30-610-05 | 5,0 cm, 2" 15-30-611-05 | | | |
| |  |  | | | |
| | 7,0 cm, 2¾" 15-30-610-07 | 7,0 cm, 2¾" 15-30-611-07 | | | |
|  | scharf sharp pointu agudos острые | stumpf blunt mousse romo тупые | |  | |
| FINSEN | | | | JANSEN 10,0 cm, 4" | |
| | | | |  |  |
| | | | | 15-30-630-10 | 15-30-631-10 |
| | | | | scharf sharp pointu agudos острые | stumpf blunt mousse romo тупые |

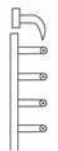
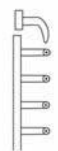
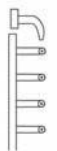
| | | | | | |
|---|----------------------------|---|---|---|--|
| | | scharf sharp pointu agudos острые | halbscharf semi-sharp semi-pointu semi-agudos полуострые | stumpf blunt mousse romo тупые | |
|  | |  |  |  | |
| | 7,0 cm, 2¾" 10,0 cm, 4" | 15-30-620-07 | 15-30-622-07 | 15-30-621-07 | |
| | | 15-30-620-10 | 15-30-622-10 | 15-30-621-10 | |

ALM



ALLPORT
 9,5 cm, 3¾"
 15-30-626-09



scharf
 sharp
 pointu
 agudos
 острые

15-30-660-14

stumpf
 blunt
 mousse
 romo
 тупые

15-30-661-14

SALP-CONTOUR
 14,0 cm, 5½"



scharf
 sharp
 pointu
 agudos
 острые

13,0 cm, 5" **15-30-684-13**
 16,0 cm, 6¼" **15-30-684-16**

stumpf
 blunt
 mousse
 romo
 тупые

13,0 cm, 5" **15-30-685-13**
 16,0 cm, 6¼" **15-30-685-16**

ADSON-BABY

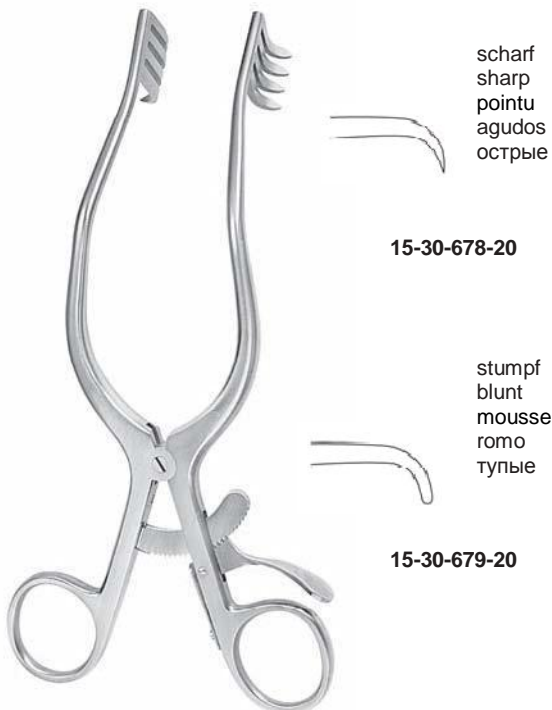

scharf
 sharp
 pointu
 agudos
 острые

15-30-678-20

stumpf
 blunt
 mousse
 romo
 тупые

15-30-679-20

ANDERSON-ADSON
 20,0 cm, 8"

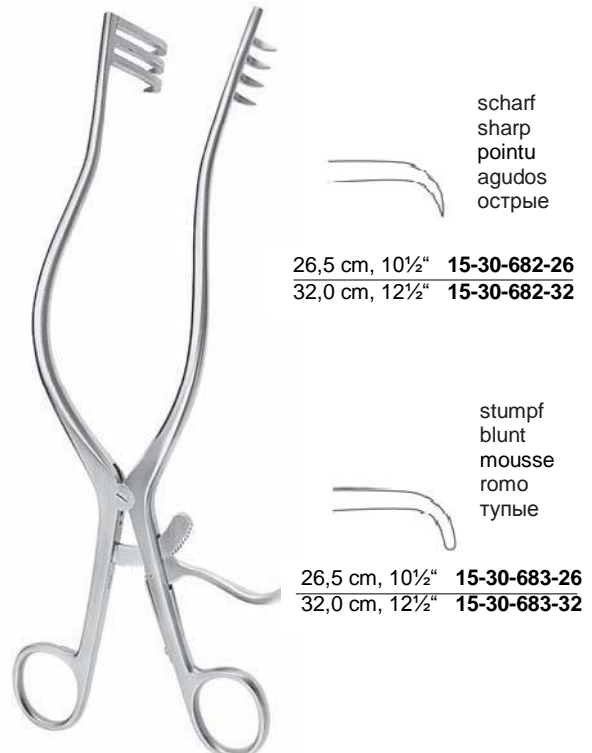

scharf
 sharp
 pointu
 agudos
 острые

26,5 cm, 10½" **15-30-682-26**
 32,0 cm, 12½" **15-30-682-32**

stumpf
 blunt
 mousse
 romo
 тупые

26,5 cm, 10½" **15-30-683-26**
 32,0 cm, 12½" **15-30-683-32**

ADSON

Wundspreizer
Self-Retaining Retractors
Ecarteurs autostatiques
Separadores con retenida automática
Самоудерживающиеся ранорасширители



MOLLISON
15,5 cm, 6"

scharf
sharp
pointu
agudos
острые

15-30-674-15



stumpf
blunt
mousse
romo
тупые

15-30-675-15



SCHUHKNECHT
12,5 cm, 5"

scharf
sharp
pointu
agudos
острые

15-30-800-12



stumpf
blunt
mousse
romo
тупые

15-30-800-14



3 x 3



WULLSTEIN



scharf
sharp
pointu
agudos
острые



stumpf
blunt
mousse
romo
тупые

| | | |
|----------------------------|--------------|--------------|
| 10,0 cm, 4" | 15-30-810-10 | 15-30-811-10 |
| 13,0 cm, 5" | 15-30-810-13 | 15-30-811-13 |
| 16,0 cm, 6 $\frac{3}{4}$ " | 15-30-810-15 | 15-30-811-16 |
| 18,0 cm, 7" | 15-30-810-18 | 15-30-811-18 |

3 x 4



WULLSTEIN



scharf
sharp
pointu
agudos
острые



stumpf
blunt
mousse
romo
тупые

| | | |
|----------------------------|--------------|--------------|
| 18,0 cm, 7" | 15-30-812-18 | 15-30-813-18 |
| 21,0 cm, 8 $\frac{1}{4}$ " | 15-30-812-21 | 15-30-813-21 |



MAYO-ADAMS
16,5 cm, 6½"
15-30-822-17



mit Mittelblatt
with central blade
avec valve centrale
con valve central
с центральной лопаткой

MAYO-ADAMS
17,0 cm, 6¾"
15-30-320-17

Wundspreizer
 Self-Retaining Retractors
 Ecarteurs autostatiques
 Separadores con retenida automática
 Самоудерживающиеся ранорасширители



WEITLANER-LOKTITE
 10,5 cm, 4 1/8"



15-30-650-10

scharf
 sharp
 pointu
 agudos
 острые



15-30-651-10

stumpf
 blunt
 mousse
 romo
 тупые



WEITLANER



10,5 cm, 4 1/8" **15-30-670-10**
 13,0 cm, 5" **15-30-670-13**

scharf
 sharp
 pointu
 agudos
 острые



10,5 cm, 4 1/8" **1530-671-10**
 13,0 cm, 5" **1530-671-13**

stumpf
 blunt
 mousse
 romo
 тупые



WEITLANER
 16,5 cm, 6 1/2"



15-30-670-16

scharf
 sharp
 pointu
 agudos
 острые



15-30-671-16

stumpf
 blunt
 mousse
 romo
 тупые



WEITLANER
 20,0 cm, 8"



15-30-670-20

scharf
 sharp
 pointu
 agudos
 острые



15-30-671-20

stumpf
 blunt
 mousse
 romo
 тупые



WEITLANER
26,0 cm, 10 1/4"

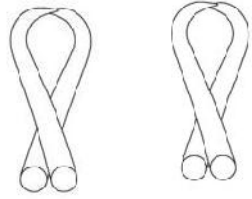

scharf
sharp
pointu
agudos
острые

stumpf
blunt
mousse
romo
тупые

3 x 4
15-30-670-34 15-30-671-34

5 x 6
15-30-670-56 15-30-671-56



PLESTER



scharf
sharp
pointu
agudos
острые

10,0 cm, 4" 15-30-830-10
13,0 cm, 5" 15-30-830-13



stumpf
blunt
mousse
romo
тупые

10,0 cm, 4" 15-30-831-10
13,0 cm, 5" 15-30-831-13



MILLIGAN
13,0 cm, 5"

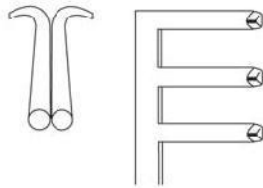

15-30-840-13 15-30-841-13

stumpf
blunt
mousse
romo
тупые

scharf
sharp
pointu
agudos
острые



PLESTER
11,0 cm, 4 3/4"
15-30-672-11

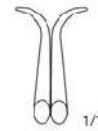

PLESTER
11,0 cm, 4 3/4"
15-30-673-11

Wundspreizer
 Self-Retaining Retractors
 Ecarteurs autostatiques
 Separadores con retenida automática
 Самоудерживающиеся ранорасширители



WEITLANER-BABY
 13,0 cm, 5"
 15-30-850-13



**ADSON
 (CONE)**

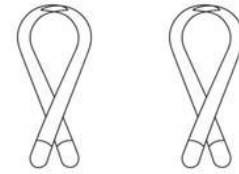

| | | |
|---|--------------|--------------|
| 13,0 cm, 5" | 15-30-860-13 | 15-30-861-13 |
| 16,0 cm, 6 ³ / ₄ " | 15-30-860-16 | 15-30-861-16 |
| 20,0 cm, 8" | 15-30-860-20 | 15-30-861-20 |
| 26,0 cm, 10 ¹ / ₄ " | 15-30-860-26 | 15-30-861-26 |

| | |
|--------|--------|
| scharf | stumpf |
| sharp | blunt |
| pointu | mousse |
| agudos | romo |
| острые | тупые |

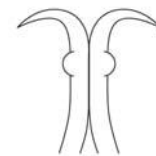

GELPI
 9,0 cm, 3¹/₂" 15-30-202-09
 11,0 cm, 4³/₄" 15-30-202-11
 13,0 cm, 5" 15-30-202-13
 19,0 cm, 7¹/₂" 15-30-202-19



GELPI

stumpf
 blunt
 mousse
 romo
 тупые

15,0 cm, 6" 15-30-205-15

scharf
 sharp
 pointu
 agudos
 острые

15,0 cm, 6" 15-30-204-15
 17,0 cm, 6³/₄" 15-30-204-17



GELPI-LOKITE
 18,0 cm, 7"
 15-30-250-19

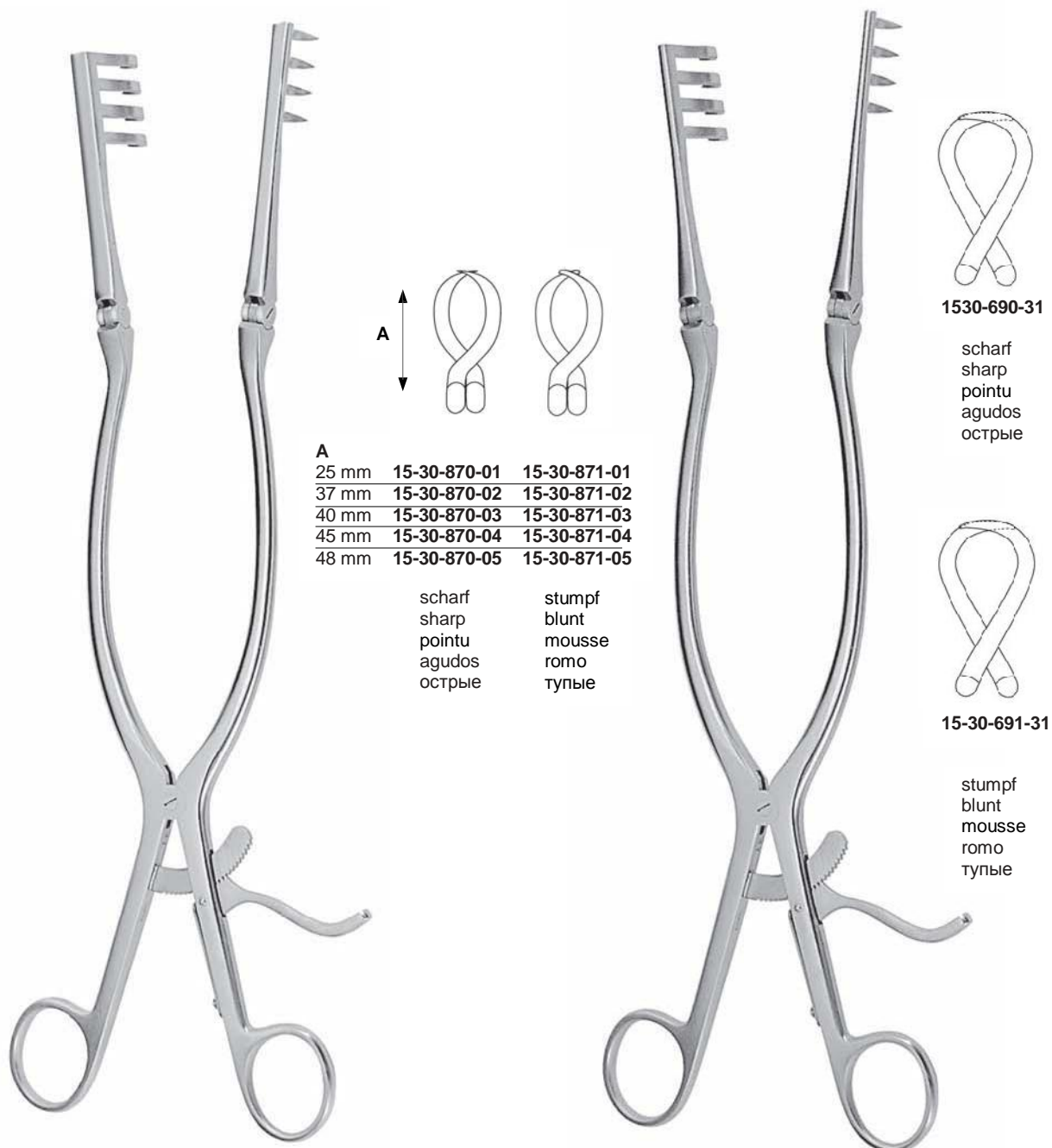

| A | 15-30-870-01 | 15-30-871-01 |
|-------|--------------|--------------|
| 25 mm | 15-30-870-01 | 15-30-871-01 |
| 37 mm | 15-30-870-02 | 15-30-871-02 |
| 40 mm | 15-30-870-03 | 15-30-871-03 |
| 45 mm | 15-30-870-04 | 15-30-871-04 |
| 48 mm | 15-30-870-05 | 15-30-871-05 |

| | |
|--------|--------|
| scharf | stumpf |
| sharp | blunt |
| pointu | mousse |
| agudos | romo |
| острые | тупые |

1530-690-31

scharf
 sharp
 pointu
 agudos
 острые

15-30-691-31

stumpf
 blunt
 mousse
 romo
 тупые

BECKMANN-ADSON
 31,0 cm, 12¼"

BECKMANN
 31,0 cm, 12¼"

Wundspreizer
 Self-Retaining Retractors
 Ecarteurs autostatiques
 Separadores con retenida automática
 Самоудерживающиеся ранорасширители



BECKMANN
 33,0 cm, 12½"



15-30-691-32

stumpf
 blunt
 mousse
 romo
 тупые



15-30-690-32

scharf
 sharp
 pointu
 agudos
 острые



DE BAKEY

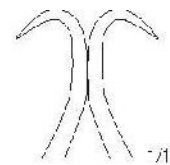

10,0 cm, 4" **15-30-240-10**
 14,0 cm, 5½" **15-30-240-14**

Wundspreizer
Self-Retaining Retractors
Ecarteurs autostatiques
Separadores con retenida automática
Самоудерживающиеся ранорасширители



stumpf
 blunt
 mousse
 тупые

NORFOLK AND NORWICH
 22,0 cm, 8 $\frac{3}{4}$ "
 15-30-401-22



stumpf
 blunt
 mousse
 тупые

JACKSON BURROWS
 17,5 cm, 7"
 15-30-411-17



RICHTER
 17,0 cm, 6 $\frac{3}{4}$ "
 15-30-420-17



JOLL (FRIEDMAN)
 15,5 cm, 6"
 15-30-430-15

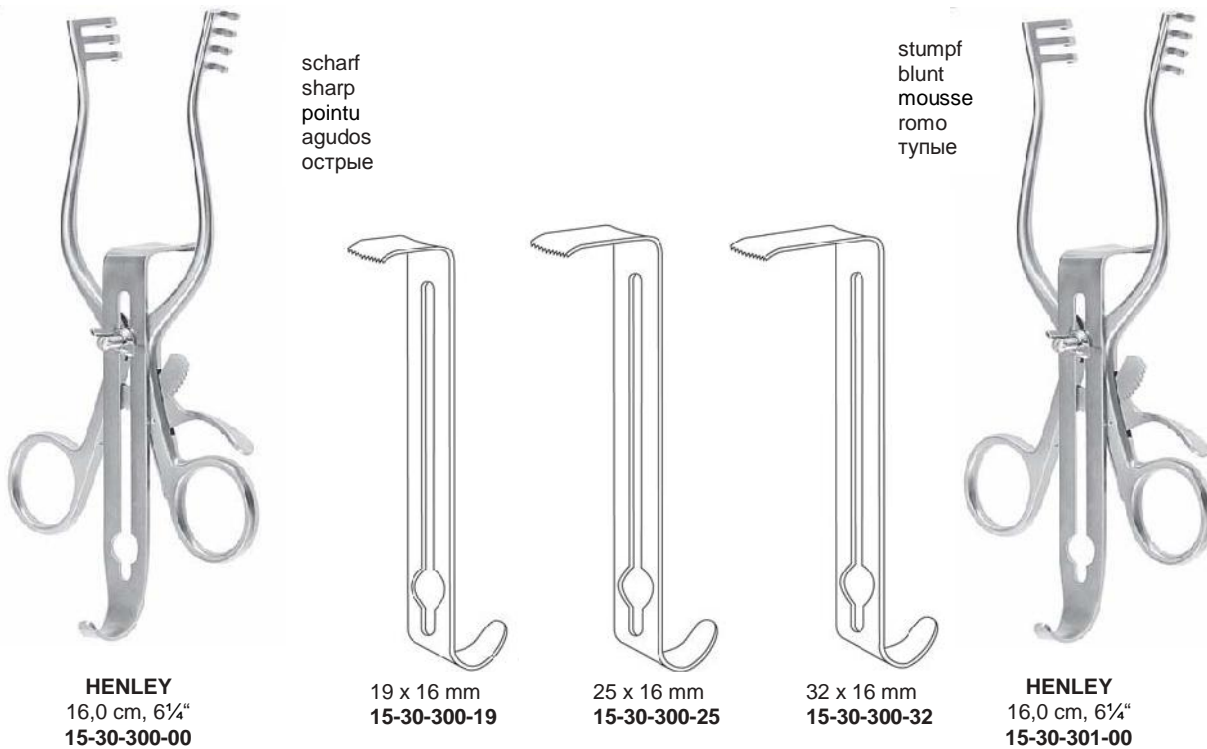

komplett, bestehend aus:

- 1 Sperrer mit Seitenvalven, scharf (1530-300-18)
- 1 Mittelvalve 19 x 16 mm (1530-300-19)
- 1 Mittelvalve 25 x 16 mm (1530-300-25)
- 1 Mittelvalve 32 x 16 mm (1530-300-32)

complete, consisting of:

- 1 Spreader with lateral valves, sharp (1530-0300-18)
- 1 Central valve 19 x 16 mm (1530-300-19)
- 1 Central valve 25 x 16 mm (1530-300-25)
- 1 Central valve 32 x 16 mm (1530-300-32)

complet consistant de:

- 1 écarteur avec valves latérales, pointu (1530-300-18)
- 1 valve central 19 x 16 mm (1530-300-19)
- 1 valve central 25 x 16 mm (1530-300-25)
- 1 valva central 32 x 16 mm (1530-300-32)

completo, compuesto of:

- 1 Separadorcon valvas laterales, agudas (1530-300-18)
- 1 Valva central 19 x 16 mm (1530-300-19)
- 1 Valva central 25 x 16 mm (1530-300-25)
- 1 Valva central 32 x 16 mm (1530-300-32)

КОМПЛЕКТ СОСТОИТ ИЗ:

- 1 расширитель с боковыми шпателями, острые (1530-300-18)
- 1 центральный шпатель 19 x 16 мм (1530-300-19)
- 1 центральный шпатель 25 x 16 мм (1530-300-25)
- 1 центральный шпатель 32 x 16 мм (1530-300-32)

komplett, bestehend aus:

- 1 Sperrer mit Seitenvalven, stumpf (1530-301-18)
- 1 Mittelvalve 19 x 16 mm (1530-300-19)
- 1 Mittelvalve 25 x 16 mm (1530-300-25)
- 1 Mittelvalve 32 x 16 mm (1530-300-32)

complete, consisting of:

- 1 Spreader with lateral valves, blunt (1530-301-18)
- 1 Central valve 19 x 16 mm (1530-300-19)
- 1 Central valve 25 x 16 mm (1530-300-25)
- 1 Central valve 32 x 16 mm (1530-300-32)

complet consistant de:

- 1 écarteur avec valves latérales, mousse (1530-301-18)
- 1 valva central 19 x 16 mm (1530-300-19)
- 1 valve central 25 x 16 mm (1530-300-25)
- 1 valva central 32 x 16 mm (1530-300-32)

completo, compuesto of:

- 1 Separadorcon valvas laterales, romas (30-301-18)
- 1 Valva central 19 x 16 mm (1530-300-19)
- 1 Valva central 25 x 16 mm (1530-300-25)
- 1 Valva central 32 x 16 mm (1530-300-32)

КОМПЛЕКТ СОСТОИТ ИЗ:

- 1 расширитель с боковыми шпателями, тупые (1530-301-18)
- 1 центральный шпатель 19 x 16 мм (1530-300-19)
- 1 центральный шпатель 25 x 16 мм (1530-300-25)
- 1 центральный шпатель 32 x 16 мм (1530-300-32)

- 15-30-300-18** Sperrer mit Seitenvalven 18 mm, scharf / Spreader with lateral valves 18 mm, sharp / Separadorcon valvas laterales 18 mm, agudas / écarteur avec valves latérales 18 mm, pointu / расширитель с боковыми шпателями 18 mm, острые
- 15-30-300-27** Sperrer mit Seitenvalven 27 mm, scharf / Spreader with lateral valves 27 mm, sharp / Separadorcon valvas laterales 27 mm, agudas / écarteur avec valves latérales 27 mm, pointu / расширитель с боковыми шпателями 27 mm, острые
- 15-30-300-58** Sperrer mit Seitenvalven 58 mm, scharf / Spreader with lateral valves 58 mm, sharp / Separadorcon valvas laterales 58 mm, agudas / écarteur avec valves latérales 58 mm, pointu / расширитель с боковыми шпателями 58 mm, острые
- 15-30-301-18** Sperrer mit Seitenvalven 18 mm, stumpf / Spreader with lateral valves 18 mm, blunt / Separadorcon valvas laterales 18 mm, romas / écarteur avec valves latérales 18 mm, mousse / расширитель с боковыми шпателями 18 mm, тупые
- 15-30-301-27** Sperrer mit Seitenvalven 27 mm, stumpf / Spreader with lateral valves 27 mm, blunt / Separadorcon valvas laterales 27 mm, romas / écarteur avec valves latérales 27 mm, mousse / расширитель с боковыми шпателями 27 mm, тупые
- 15-30-301-58** Sperrer mit Seitenvalven 58 mm, stumpf / Spreader with lateral valves 58 mm, blunt / Separadorcon valvas laterales 58 mm, romas / écarteur avec valves latérales 58 mm, mousse / расширитель с боковыми шпателями 58 mm, тупые

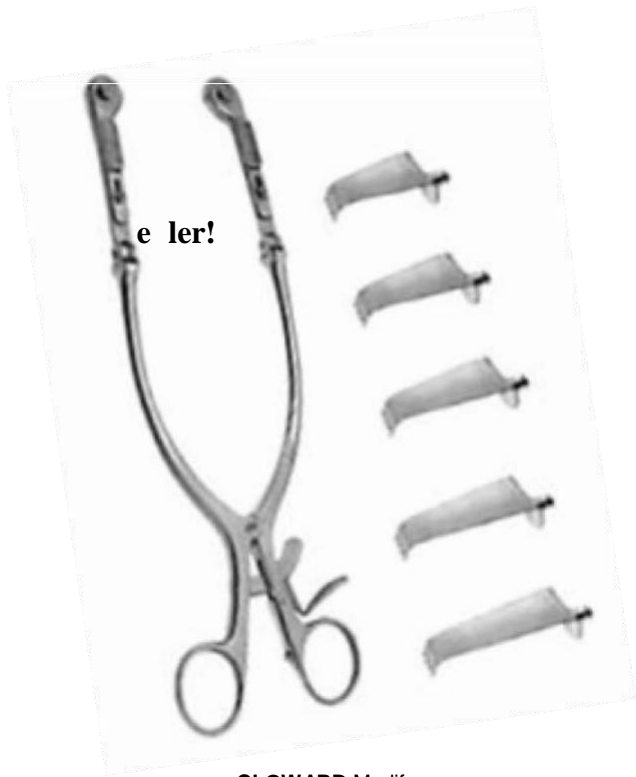

CLOWARD Modif.
 25,0 cm, 10"
15-72-460-00



15-72-461-25



15-72-461-25Z

15-72-460-00 Cloward Spreizer Set komplett mit 14 Valven, 25 cm
RetractorSet complete with 14 blades, 25 cm
Ecarteurs autostatiques complet avec 14 valves, 25 cm **Separadores con**
retenida automatic completo 14 valvas, 25 cm **Самоудерживающийся**
ранорасширитель в комплекте с 14 лопатками, 25 см

15-72-460-01 Sperrer allein / Spreader only / écarteur seul / Ecarteur suelto / только рамка

15-72-461-25 Valven 25 mm, stumpf / blades 25 mm, blunt / valves 25 mm, mousse / Valvas 25 mm / сменные лопатки 25 mm, тупые

15-72-461-25Z Valven 25 mm, scharf / blades 25 mm, sharp / valves 25 mm, pointu / Valvas 25 mm / сменные лопатки 25 mm, острые

15-72-461-30 Valven 30 mm, stumpf / blades 30 mm, blunt / valves 30 mm, mousse / Valvas 30 mm / сменные лопатки 30 mm, тупые

15-72-461-30Z Valven 30 mm, scharf / blades 30 mm, sharp / valves 30 mm, pointu / Valvas 30 mm / сменные лопатки 30 mm, острые

15-72-461-35 Valven 35 mm, stumpf / blades 35 mm, blunt / valves 35 mm, mousse / Valvas 35 mm / сменные лопатки 35 mm, тупые

15-72-461-35Z Valven 35 mm, scharf / blades 35 mm, sharp / valves 35 mm, pointu / Valvas 35 mm / сменные лопатки 35 mm, острые

15-72-461-40 Valven 40 mm, stumpf / blades 40 mm, blunt / valves 40 mm, mousse / Valvas 40 mm / сменные лопатки 40 mm, тупые

15-72-461-40Z Valven 40 mm, scharf / blades 40 mm, sharp / valves 40 mm, pointu / Valvas 40 mm / сменные лопатки 40 mm, острые

15-72-461-45 Valven 45 mm, stumpf / blades 45 mm, blunt / valves 45 mm, mousse / Valvas 45 mm / сменные лопатки 45 mm, тупые

15-72-461-45Z Valven 45 mm, scharf / blades 45 mm, sharp / valves 45 mm, pointu / Valvas 45 mm / сменные лопатки 45 mm, острые

15-72-461-50 Valven 50 mm, stumpf / blades 50 mm, blunt / valves 50 mm, mousse / Valvas 50 mm / сменные лопатки 50 mm, тупые

15-72-461-50Z Valven 50 mm, scharf / blades 50 mm, sharp / valves 50 mm, pointu / Valvas 50 mm / сменные лопатки 50 mm, острые

15-72-461-55 Valven 55 mm, stumpf / blades 55 mm, blunt / valves 55 mm, mousse / Valvas 55 mm / сменные лопатки 55 mm, тупые

15-72-461-55Z Valven 55 mm, scharf / blades 55 mm, sharp / valves 55 mm, pointu / Valvas 55 mm / сменные лопатки 55 mm, острые

Wundspreizer
 Self-Retaining Retractors
 Ecarteurs autostatiques
 Separadores con retenida automática
 Самоудерживающиеся ранорасширители

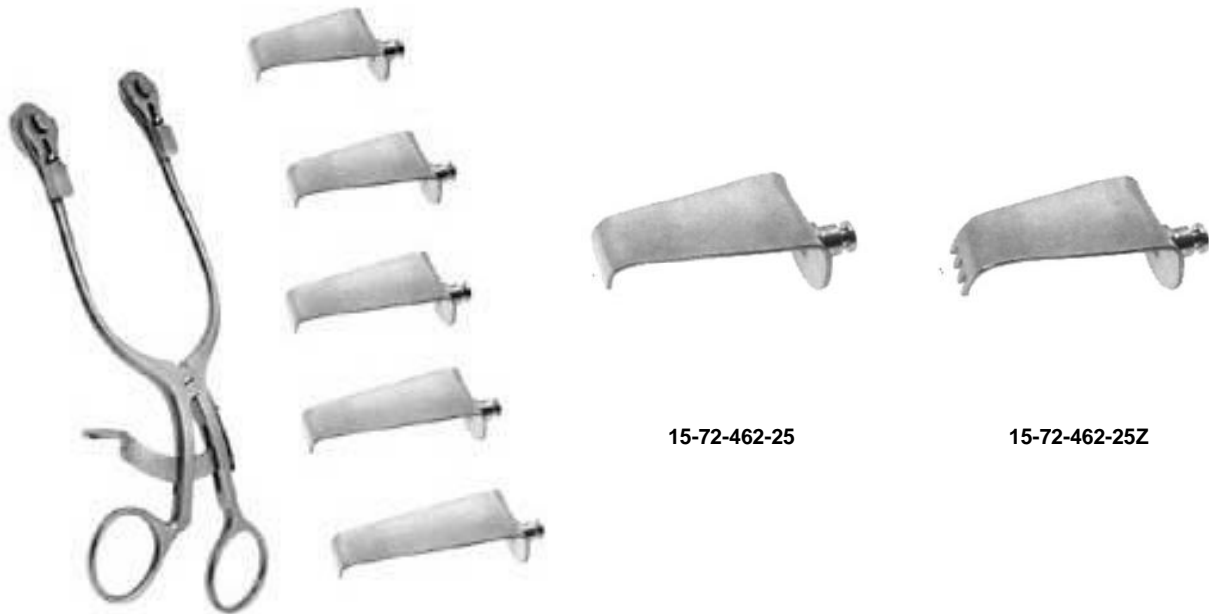

CLOWARD Modif
 16,5 cm, 6 1/2"
 15-72-465-00

15-72-465-00 Cloward Spreizer Set komplett mit 14 Valven, 16,5 cm
Retractor Set complete with 14 blades, 16,5 cm
Ecarteurs autostatiques complet avec 14 valves 16,5 cm Separadores con retenida
automatic completo 14 valvas, 16,5 cm Самоудерживающийся
ранорасширитель в комплекте с 14 лопатками, 16,5 см

15-72-465-01 Sperrer allein / Spreader only / écarteur seul / Ecarteur suelto / только рамка

15-72-462-25 Valven 25 mm, stumpf / blades 25 mm, blunt / valves 25 mm, mousse / Valvas 25 mm / сменные лопатки 25 mm, тупые

1572-462-25Z Valven 25 mm, scharf / blades 25 mm, sharp / valves 25 mm, pointu / Valvas 25 mm / сменные лопатки 25 mm, острые

15-72-462-30 Valven 30 mm, stumpf / blades 30 mm, blunt / valves 30 mm, mousse / Valvas 30 mm / сменные лопатки 30 mm, тупые

15-72-462-30Z Valven 30 mm, scharf / blades 30 mm, sharp / valves 30 mm, pointu / Valvas 30 mm / сменные лопатки 30 mm, острые

15-72-462-35 Valven 35 mm, stumpf / blades 35 mm, blunt / valves 35 mm, mousse / Valvas 35 mm / сменные лопатки 35 mm, тупые

15-72-462-35Z Valven 35 mm, scharf / blades 35 mm, sharp / valves 35 mm, pointu / Valvas 35 mm / сменные лопатки 35 mm, острые

15-72-462-40 Valven 40 mm, stumpf / blades 40 mm, blunt / valves 40 mm, mousse / Valvas 40 mm / сменные лопатки 40 mm, тупые

15-72-462-40Z Valven 40 mm, scharf / blades 40 mm sharp / valves 40 mm, pointu / Valvas 40 mm / сменные лопатки 40 mm, острые

15-72-462-45 Valven 45 mm, stumpf / blades 45 mm, blunt / valves 45 mm, mousse / Valvas 45 mm / сменные лопатки 45 mm, тупые

15-72-462-45Z Valven 45 mm, scharf / blades 45 mm, sharp / valves 45 mm, pointu / Valvas 45 mm / сменные лопатки 45 mm, острые

15-72-462-50 Valven 50 mm, stumpf / blades 50 mm, blunt / valves 50 mm, mousse / Valvas 50 mm / сменные лопатки 50 mm, тупые

15-72-462-50Z Valven 50 mm, scharf / blades 50 mm, sharp / valves 50 mm, pointu / Valvas 50 mm / сменные лопатки 50 mm, острые

15-72-462-55 Valven 55 mm, stumpf / blades 55 mm, blunt / valves 55 mm, mousse / Valvas 55 mm / сменные лопатки 55 mm, тупые

15-72-462-55Z Valven 55 mm, scharf / blades 55 mm, sharp / valves 55 mm, pointu / Valvas 55 mm / сменные лопатки 55 mm, острые



COLLIN-BABY
 18,0 cm, 7"
15-30-330-18



18 x 42 mm **15-30-330-23**
 28 x 42 mm **15-30-330-30**

Wechselvalven
 Exchangeable blades
 Valves latéral
 Valvas intergambiables
 Сменные лопатки

60 x 80 mm **15-31-399-23**
 72 x 85 mm **15-31-399-14**



55 x 70 mm **15-31-310-02**
 80 x 90 mm **15-31-310-03**

28,0 cm, 11" **15-31-310-10**
 30,0 cm, 12" **15-31-312-10**

Sperrer allein
 Spreader only
 Ecarteur
 Separator profundos
 Только рамка

RICHARD

280 mm **15-31-310-28 (15-31-310-10 / 15-31-310-02 / 15-31-399-23)**
 300 mm **15-31-312-30 (15-31-312-10 / 15-31-310-03 / 15-31-399-14)**

besteht aus: Sperrer, 1 Paar Valven, 1 Mittelvalve
 consisting of: Spreader, 1 Paar of Blades, 1 central Blade
 consistant de: Ecarteur, 1 paire de valves, 1 valve centrale
 compuesto de: Separator, 1 pareja de valvas, 1 valva centrale
 состоит из: рамки, 1 пары сменных лопаток, 1 центрального шпателя

Bauchdeckenhalter
Abdominal Retractors
Ecarteurs abdominaux
Separadores abdominales
Расширители для брюшины



COLLIN

| Central | COLLIN | Lateral |
|------------|---------------------|------------|
| 38 x 55 mm | 15-31-330-24 | 60 x 38 mm |
| 50 x 75 mm | 15-31-332-24 | 80 x 38 mm |

besteht aus: Sperrer, 1 Paar Valven, 1 Mittelvalve consisting of: Spreader, 1 Paar of Blades, 1 central Blade consistant de: Ecarteur, 1 paire de valves. 1 valve centrale compuesto de: Separator, 1 pareja de valvas, 1 valva centrale состоит из: рамки, 1 пары сменных лопаток, 1 центрального шпателя

38 x 62 mm
15-31-399-01



ROBIN-MASSE
15-31-360-27

15-31-360-27 (15-31-399-01+15-31-360-01)

besteht aus: Sperrer, 1 Paar Valven, 1 Mittelvalve consisting of: Spreader, 1 Paar of Blades, 1 central Blade consistant de: Ecarteur, 1 paire de valves. 1 valve centrale compuesto de: Separator, 1 pareja de valvas, 1 valva centrale состоит из: рамки, 1 пары сменных лопаток, 1 центрального шпателя

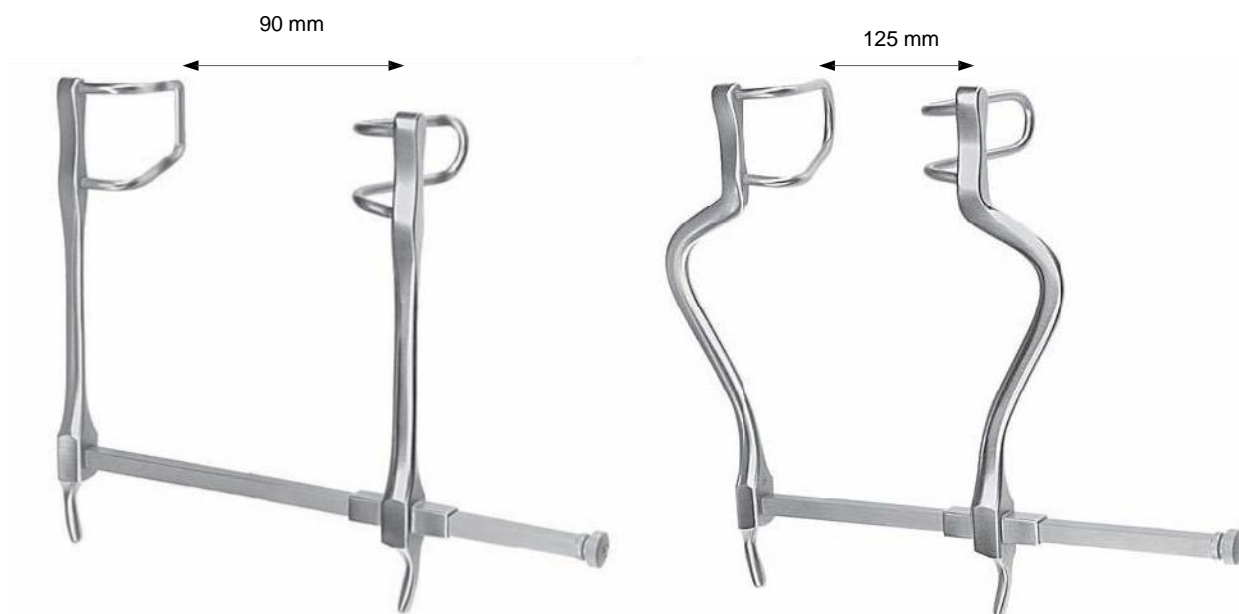

**GOSSET
15-31-400-10**

**GOSSET
15-31-412-14**



**GOSSET
15-31-414-16**

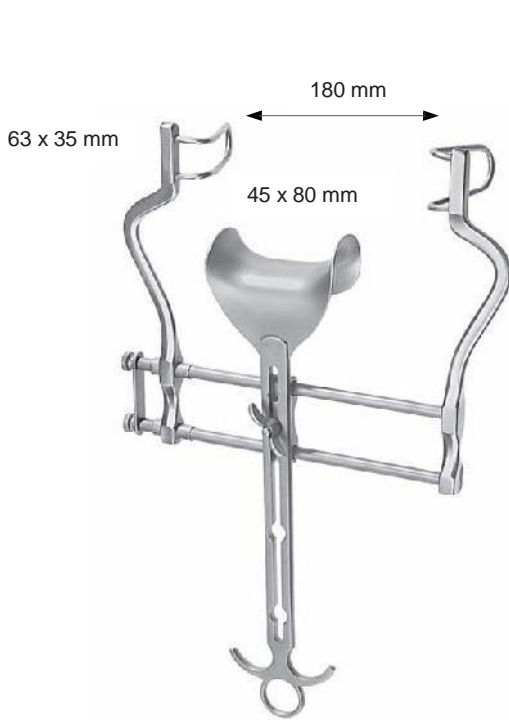

BALFOUR
 15-31-764-18

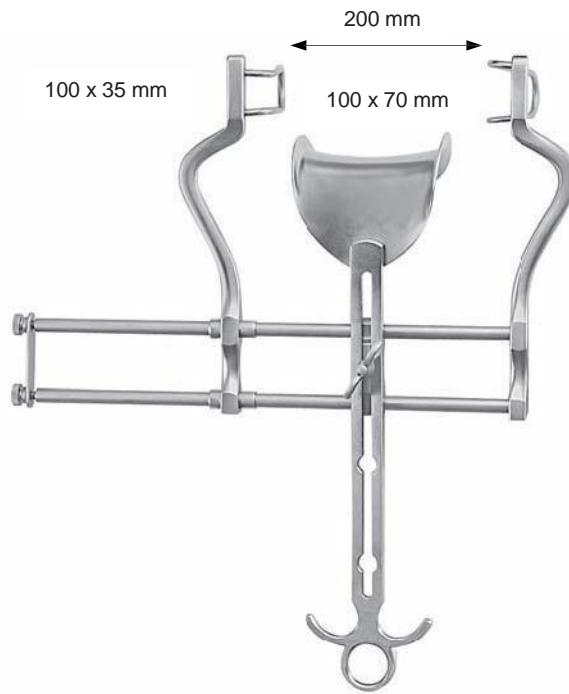

BALFOUR
 15-31-768-20



BALFOUR
 15-31-768-25

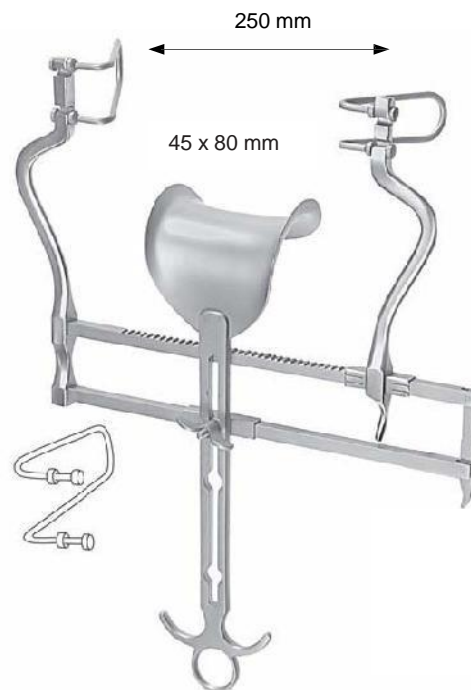

BALFOUR US-TYPE
 15-31-772-25



40 x 60 mm **15-31-798-01**
45 x 80 mm **15-31-798-02**
68 x 85 mm **15-31-798-03**
70 x 85 mm **15-31-798-04**
80 x 90 mm **15-31-798-05**
100 x 70 mm **15-31-798-06**

BALFOUR

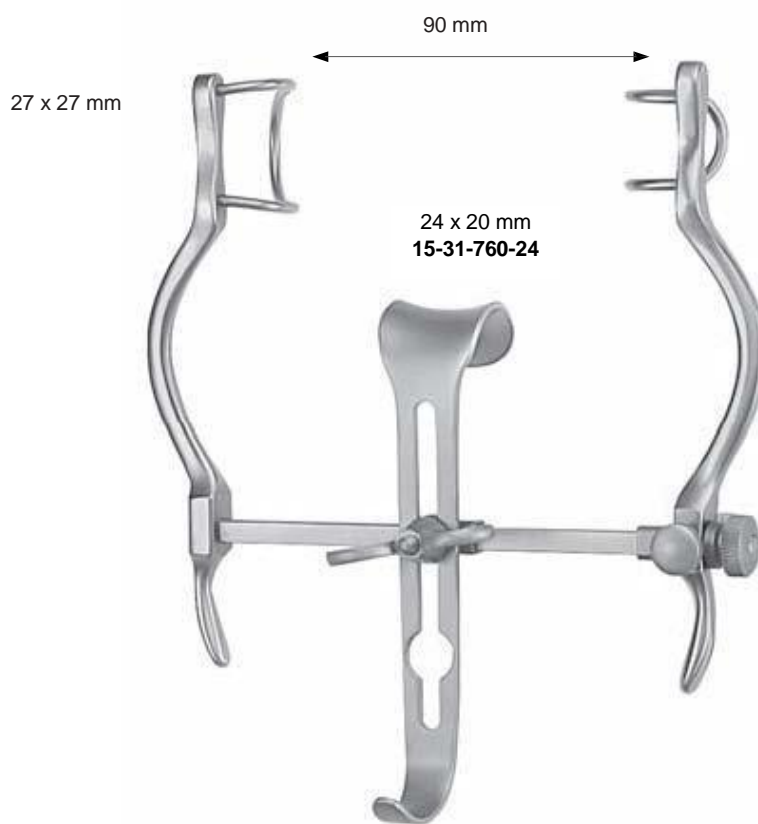

BALFOUR
15-31-760-09

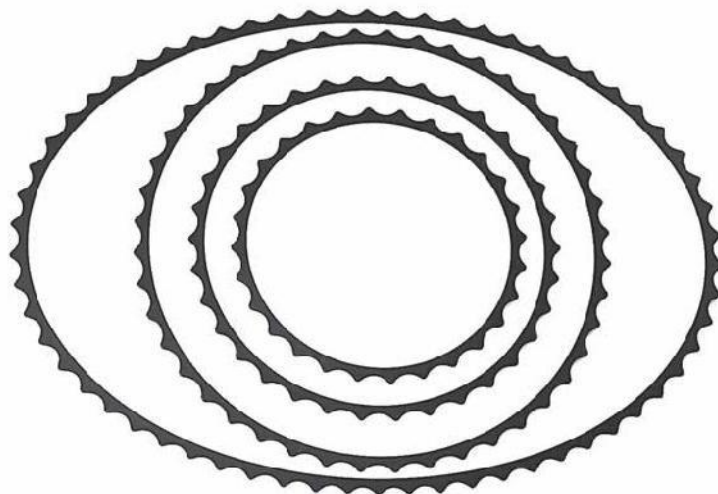

| | |
|---------------------------|--------------|
| \varnothing 180 mm, 7" | 15-31-850-18 |
| \varnothing 230 mm, 9" | 15-31-850-23 |
| \varnothing 305 mm, 12" | 15-31-850-30 |
| 455 x 330 mm | 15-31-850-45 |

geschwärzt, black finish, noircie; negra, чёрное покрытие



15-31-859-01
13 mm

15-31-859-02
51 x 38 mm

15-31-859-03
70 x 60 mm

15-31-859-04
89 x 60 mm

15-31-859-05
114 x 60 mm

15-31-860-22
 40 x 40 mm

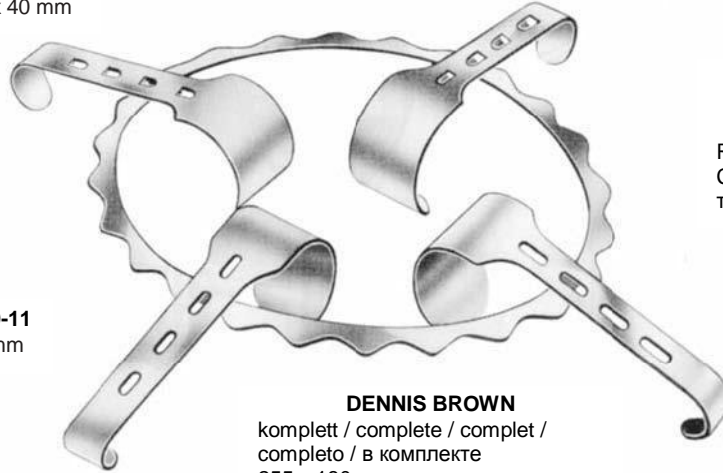

15-31-860-11
 40 x 30 mm

15-31-860-01
 255 x 180 mm

Rahmen allein / frame only /
 Cadre seul / cuadro suelto /
 только рамка

DENNIS BROWN

komplett / complete / complet /
 completo / в комплекте
 255 x 180 mm

15-31-860-00 (1x **15-31-860-01**
 2 x **15-31-860-22**
 2 x **15-31-860-11**)

15-31-870-01

Rahmen allein
 Cadre seul
 frame only
 solo telaio
 только рамка



80 x 45 mm **15-31-870-11**
 45 x 80 mm **1531-870-13**

O'SULLIVAN-O'CONNOR

15-31-870-00

komplett
 complete
 complet
 completo
 в комплекте

15-31-870-12
 110 x 70 mm

Bauchdeckenhalter
 Abdominal Retractors
 Ecarteurs abdominaux
 Separadores abdominales
 Расширители для брюшины

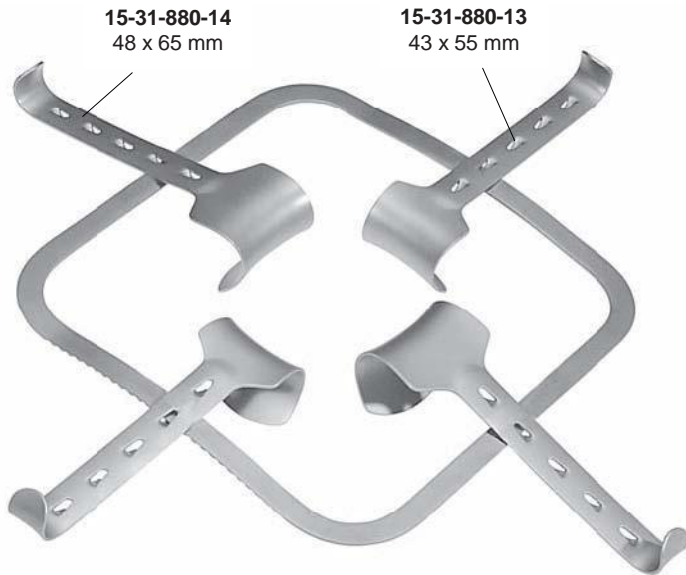

15-31-880-01
 240 x 240 mm

Rahmen allein / frame only /
 Cadre seul / cuadro suelto /
 только рамка

KIRSCHNER
15-31-880-00

komplett / complete /
 complet / completo /
 в комплекте

1 x 15-31-880-01
2 x 15-31-880-13
2 x 15-31-880-14

KIRSCHNER
15-31-880-00

15-31-882-01
 250 x 250 mm

zusammenlegbarer Rahmen, allein
 folding frame, only
 cadre pliant, seul
 cuadro piegable, suelto
 только складная рамка

KIRSCHNER
15-31-882-00

komplett / complete /
 complet / completo /
 в комплекте

1 x 15-31-882-01
2 x 15-31-880-13
2 x 15-31-880-14



43 x 55 mm **15-31-880-13**
 48 x 65 mm **15-31-880-14**
 80 x 90 mm **15-31-880-15**

KIRSCHNER



KIRSCHNER

98 x 51 mm 15-31-880-20
105 x 38 mm 15-31-880-21

15-31-880-14
48 x 65 mm

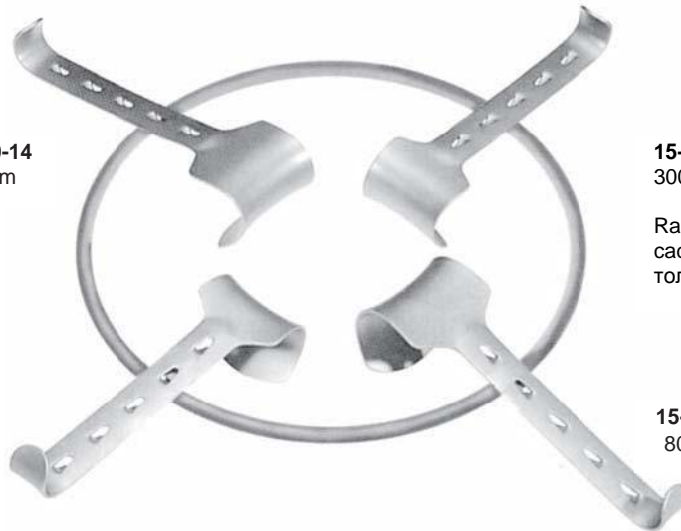

15-31-884-01
300 x 240 mm

Rahmen allein / frame only
cadre seul / cuadro suelto /
только рамка

15-31-880-15
80 x 90 mm

KIRSCHNER, oval
1531-884-00

komplett, complete,
complet, completo,
в комплекте

1 x 15-31-884-01
3 x 15-31-880-14
1 x 15-31-880-15
1 x 15-31-880-20
1 x 15-31-880-21

Bauchdeckenhalter
Abdominal Retractors
Ecarteurs abdominaux
Separadores abdominales
Расширители для брюшины

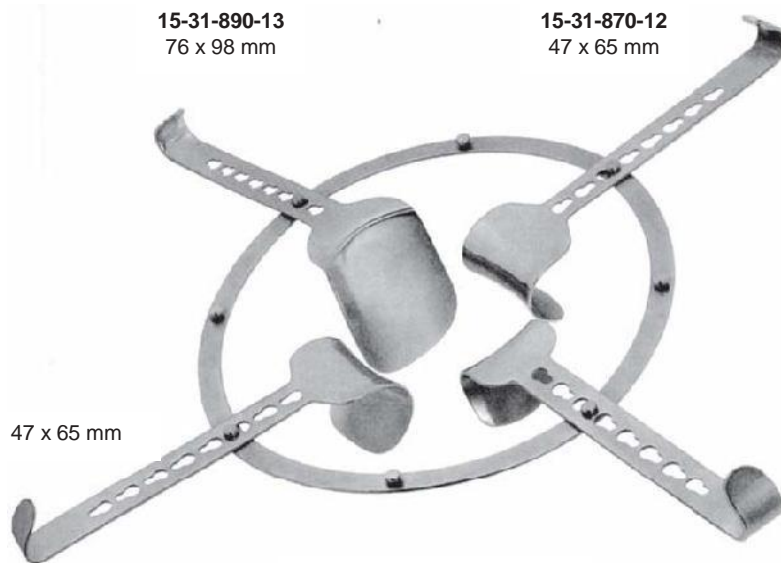

15-31-890-13
76 x 98 mm

15-31-870-12
47 x 65 mm

47 x 65 mm

15-31-890-01
275 x 250 mm

Rahmen allein / frame only /
cadre seul / cuadro suelto /
только рамка

15-31-890-15
50 x 54 mm



15-31-890-11
98 x 52 mm

15-31-890-12
105 x 35 mm

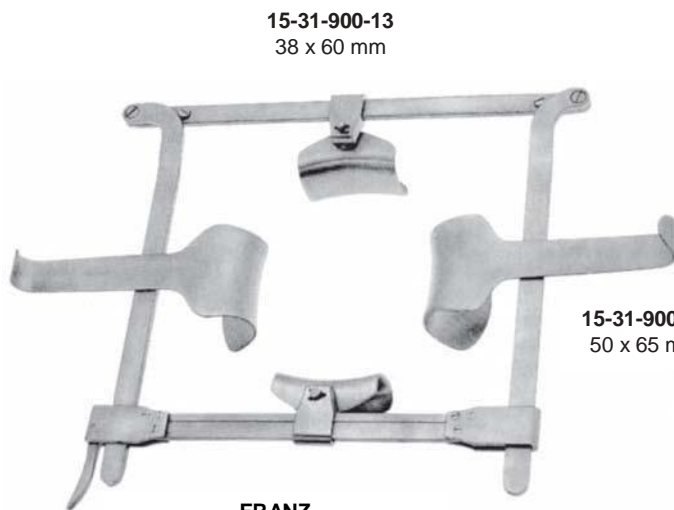

15-31-900-13
38 x 60 mm

15-31-900-11
50 x 65 mm

FRANZ
15-31-900-00

komplett / complete / complet /
completo / в комплекте

1 x 15-31-900-01
2 x 15-31-900-11
2 x 15-31-900-13



15-31-900-01
300 x 300 mm

zusammenlegbarer Rahmen, allein
folding frame, only
cadre pliant seul
cuadro plegable, suelto
только складная рамка



38 x 60 mm **15-31-900-13**
45 x 80 mm **15-31-900-14**



50 x 65 mm **15-31-900-11**
60 x 85 mm **15-31-900-12**

Bauchdeckenhalter
Abdominal Retractors
Ecarteurs abdominaux
Separadores abdominales
Расширители для брюшины

Befestigungsgestell
 Mounting frame
 Fixation châssis
 Bastidor para la fijación
 Рамка манипуляционная



ROCHARD
15-31-920-01



ROCHARD
15-31-920-02

Kette mit Gewicht
 Chain with weight
 Cadena con pesa
 Chaîne avec poids
 Цепочка с гирей



15-31-915-30
78,5 cm, 31"



DOYEN
28,0 cm, 11"

95 x 60 mm **15-31-910-11**
 105 x 65 mm **15-31-910-12**
 115 x 65 mm **15-31-910-13**
 125 x 65 mm **15-31-910-14**



ROCHARD
28,0 cm, 11"
15-31-920-20

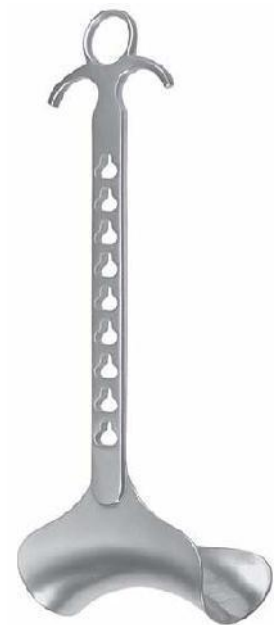

ROCHARD
28,0 cm, 11"

95 x 48 mm **15-31-920-10**
 105 x 48 mm **15-31-920-11**
 115 x 48 mm **15-31-920-12**
 125 x 48 mm **15-31-920-13**
 155 x 48 mm **15-31-920-16**



biegsam
malleable
malléable
maleable
изгибаемые

200 x 6 mm **15-32-210-06**
200 x 12 mm **15-32-210-12**
200 x 17 mm **15-32-210-17**
200 x 20 mm **15-32-210-20**
200 x 25 mm **15-32-210-25**

RIBBON



biegsam
malleable
malléable
maleable
изгибаемые

330 x 13 mm **15-32-170-13**
330 x 19 mm **15-32-170-19**
330 x 25 mm **15-32-170-25**
330 x 30 mm **15-32-170-30**
330 x 32 mm **15-32-170-32**
330 x 40 mm **15-32-170-40**
330 x 50 mm **15-32-170-50**
330 x 75 mm **15-32-170-75**

RIBBON



biegsam
malleable
malléable
maleable
изгибаемые

280 x 25/30 mm **15-32-200-01**
300 x 37/45 mm **15-32-200-02**
300 x 40/50 mm **15-32-200-03**

HABERER



biegsam
malleable
malléable
maleable
изгибаемые

TUFFIER
200 x 25/17 mm
15-32-220-20



REVERDIN
280 x 45/60 mm
15-32-230-28



rostfrei
stainless steel
inoxidable
inox
нержавеющая сталь

| | |
|----------|---|
| a | Tiefe / Depth / Profondeur / Profondite / глубина |
| b | Breite / Width / Ancho / Largeur / ширина |
| c | Spreizung / Spread / Abertura / Ecartement / расширение |

| a | b | c | |
|-------|-------|-------|--------------|
| 18 mm | 20 mm | 75 mm | 15-47-100-01 |
| 12 mm | 15 mm | 70 mm | 15-47-100-06 |

FINOCCHIETTO-BABY/INFANT

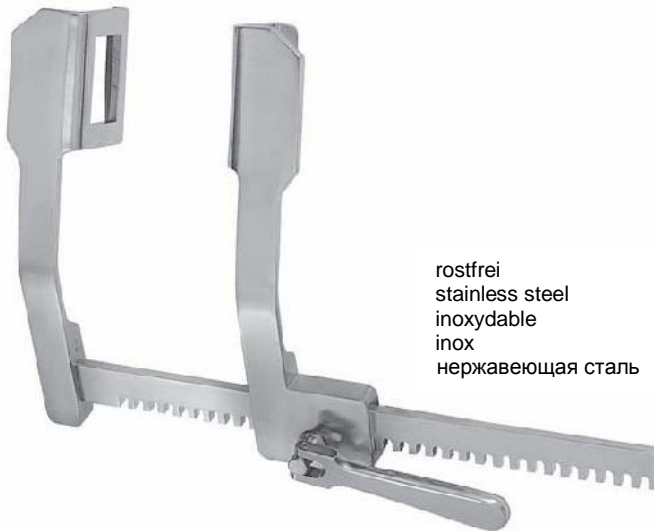

rostfrei
stainless steel
inoxidable
inox
нержавеющая сталь

| a | b | c | |
|-------|-------|--------|--------------|
| 40 mm | 40 mm | 165 mm | 15-47-100-02 |
| 45 mm | 65 mm | 200 mm | 15-47-100-03 |
| 70 mm | 65 mm | 250 mm | 15-47-100-04 |
| 70 mm | 65 mm | 300 mm | 15-47-100-05 |

FINOCCHIETTO



rostfrei
stainless steel
inoxidable
inox
нержавеющая сталь

| a | b | c | |
|-------|-------|--------|--------------|
| 50 mm | 45 mm | 165 mm | 15-47-150-01 |

TUFFIER

Rippensperrer Rib
 Spreaders Ecarteurs
 des cotes
 Separadores costales
 Рёберный расширитель

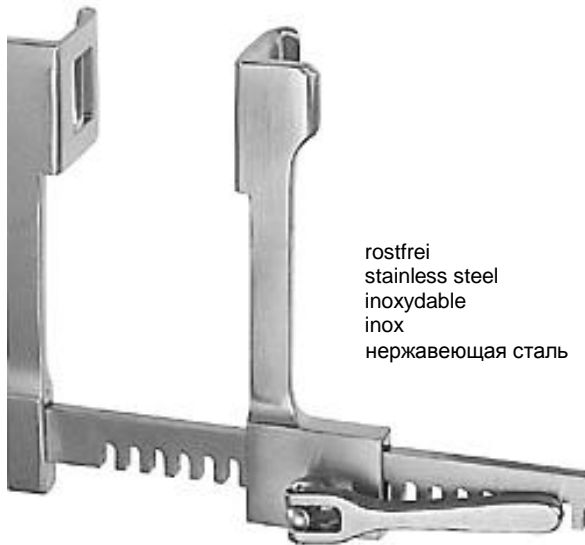

rostfrei
 stainless steel
 inoxydable
 inox
 нержавеющей сталь

a Tiefe / Depth / Profondeur / Profondite / глубина
b Breite / Width / Ancho / Largeur / ширина
c Spreizung / Spread / Aberture / Ecartement / расширение

a **b** **c**
 30 mm 30 mm 90 mm 15-47-110-00

HAIGGH



rostfrei
 stainless steel
 inoxydable
 inox
 нержавеющей сталь

a **b** **c**
 51 mm 44 mm 162 mm 15-72-450-00

BADGLEY

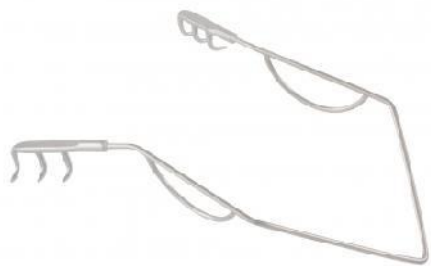

A Tiefe / Depth / Profondeur / Profondite / глубина
B Spreizung / Spread / Aberture / Ecartement / расширение

| A | B | |
|----------|----------|---------------------|
| 50 mm | 32 mm | 15-315-50-11 |
| 38 mm | 24 mm | 15-315-38-07 |
| 32 mm | 19 mm | 15-315-32-06 |
| 25 mm | 15 mm | 15-315-25-06 |



ПТП МЕДТЕХНИКА

**Sonden, Trokare, Hähne, Verbindungsstücke
Probes, Trocars, Stopcocks, Connecting Pieces
Sondes, Trocarts, Robinets, Raccords,
Sondas, Trócares, Llaves, Piezas de conexión
Зонды, троакары, запорные краны,
соединительные детали**



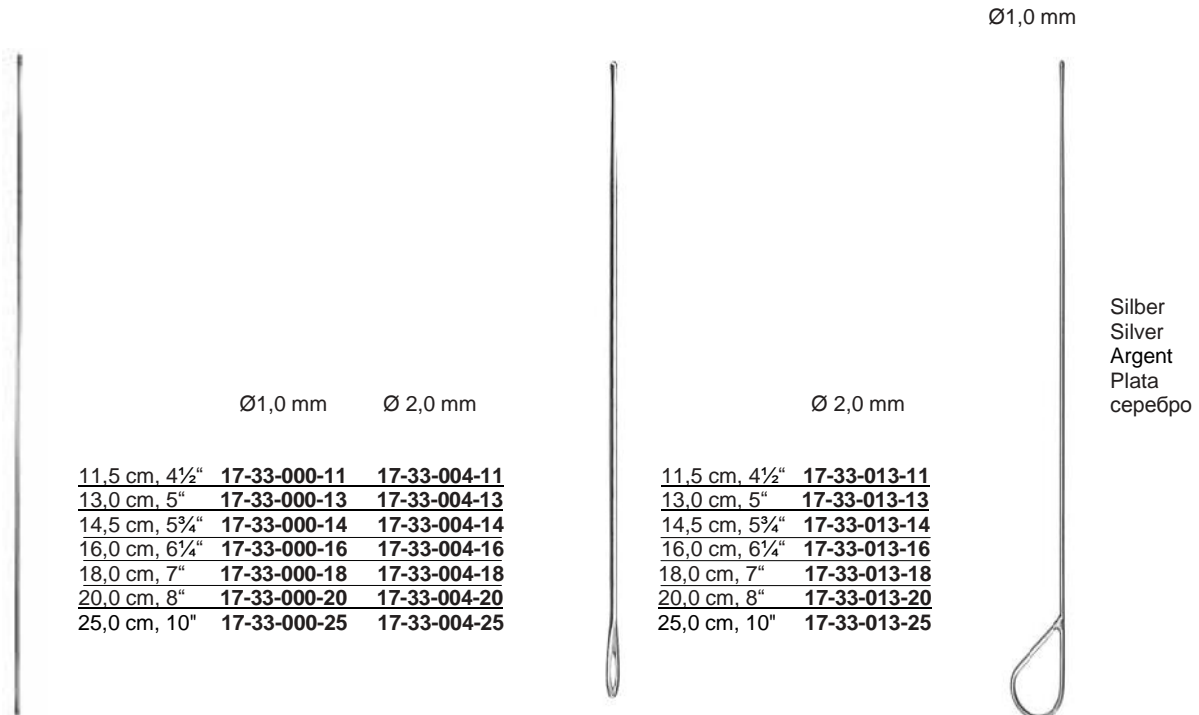

Ø1,0 mm Ø 2,0 mm Ø 2,0 mm

| | | | | |
|--------------|--------------|--------------|--------------|--------------|
| 11,5 cm, 4½" | 17-33-000-11 | 17-33-004-11 | 11,5 cm, 4½" | 17-33-013-11 |
| 13,0 cm, 5" | 17-33-000-13 | 17-33-004-13 | 13,0 cm, 5" | 17-33-013-13 |
| 14,5 cm, 5¾" | 17-33-000-14 | 17-33-004-14 | 14,5 cm, 5¾" | 17-33-013-14 |
| 16,0 cm, 6¼" | 17-33-000-16 | 17-33-004-16 | 16,0 cm, 6¼" | 17-33-013-16 |
| 18,0 cm, 7" | 17-33-000-18 | 17-33-004-18 | 18,0 cm, 7" | 17-33-013-18 |
| 20,0 cm, 8" | 17-33-000-20 | 17-33-004-20 | 20,0 cm, 8" | 17-33-013-20 |
| 25,0 cm, 10" | 17-33-000-25 | 17-33-004-25 | 25,0 cm, 10" | 17-33-013-25 |

Silber
Silver
Argent
Plata
серебро

STACKE
10,5 cm, 4⅙"
17-33-033-10



Myrtenblattsonden
Myrtle leaf probes
Sonde feuille de myrte
Sondas para mirto
Зонд - лист мирта

| | |
|--------------|--------------|
| 10,5 cm, 4⅙" | 17-33-027-11 |
| 13,0 cm, 5" | 17-33-027-13 |
| 14,5 cm, 5¾" | 17-33-027-14 |
| 16,0 cm, 6¼" | 17-33-027-16 |
| 20,0 cm, 8" | 17-33-027-20 |

NÈLATON
16,0 cm, 6¼"
17-33-120-16

DOYEN
14,0 cm, 5¾"
17-33-117-14

BRODIE
20,0 cm, 8"
17-33-126-20

Ø 3,5 mm

Ø 3,3 mm



| | |
|--------------|---------------------|
| 11,5 cm, 4½" | 17-33-110-11 |
| 13,0 cm, 5" | 17-33-110-13 |
| 14,5 cm, 5¾" | 17-33-110-14 |
| 16,0 cm, 6¾" | 17-33-110-16 |
| 18,0 cm, 7" | 17-33-110-18 |
| 20,0 cm, 8" | 17-33-110-20 |

| | |
|--------------|---------------------|
| 13,0 cm, 5" | 17-33-122-13 |
| 14,5 cm, 5¾" | 17-33-122-14 |
| 16,0 cm, 6¾" | 17-33-122-16 |
| 18,0 cm, 7" | 17-33-122-18 |

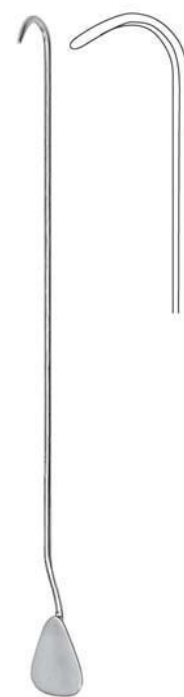
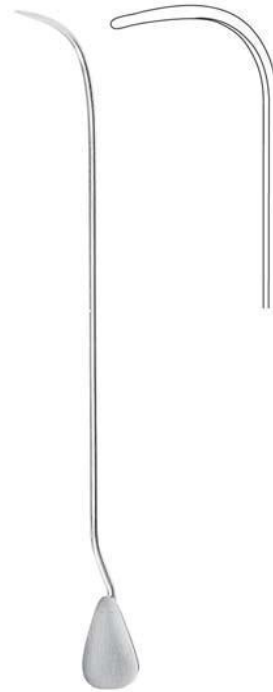
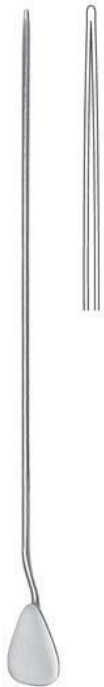

LOCKHART-MUMMERY
 16,5 cm, 6½"
17-33-130-01

LOCKHART-MUMMERY
 16,5 cm, 6½"
17-33-130-02

LOCKHART-MUMMERY
 16,5 cm, 6½"
17-33-130-03

LOCKHART-MUMMERY
 16,5 cm, 6½"
17-33-130-04

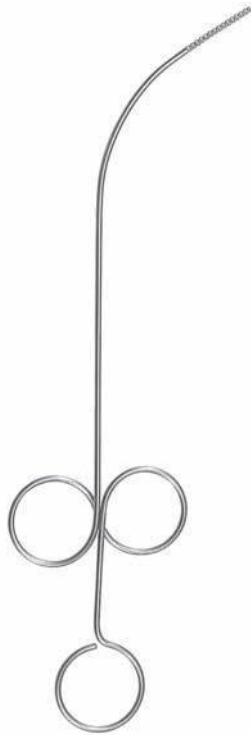

FEIN
 28,0 cm, 11"
 17-33-264-28



UKERMANN
 15,0 cm, 6"
 17-33-260-15



JOBSON-HORNE
 12,0 cm, 4 3/4" 17-33-262-12
 18,0 cm, 7" 17-33-262-18



12,0 cm, 4 3/4" 17-33-271-12 Ø 0,9 mm
 14,0 cm, 5 3/4" 17-33-271-14 Ø 0,9 mm
 16,5 cm, 6 1/4" 17-33-271-16 Ø 1,1 mm
 18,0 cm, 7" 17-33-271-18 Ø 1,2 mm

**FARRELL
 (LATHBURY)**



12,0 cm, 4 3/4" 17-33-270-12 Ø 0,9 mm
 14,0 cm, 5 3/4" 17-33-270-14 Ø 0,9 mm
 16,5 cm, 6 1/4" 17-33-270-16 Ø 1,1 mm
 18,0 cm, 7" 17-33-270-18 Ø 1,2 mm
 23,0 cm, 9" 17-33-270-23 Ø 1,2 mm

FARRELL



17-33-150-01
 135 x 100 x 25 mm

Metalletui
 Metal case
 Boite en Métal
 Estuche de metal
 Коробка металлическая

NABATOFF
17-33-150-00

komplett / complete /
 complet / completo /
 комплект



17-33-150-21

Zugseil
 Cable
 Câble tracteur
 Cable
 Кабель

17-33-150-22

Kunststoff-Sondenspitze
 Plastic probe tip
 Pointe en Plastique
 Extremidad de sonda de plástico
 Пластмассовый наконечник зонда



Ø 3,0 mm
17-33-150-03



Ø 6,0 mm
17-33-150-06



Ø 9,0 mm
17-33-150-09



Ø 12,0 mm
17-33-150-12

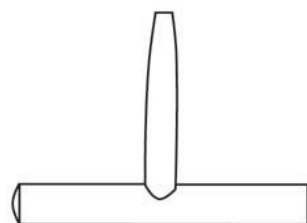

17-33-150-20

Handgriff
 Handle
 Manche Tracteur
 Mango
 Ручка



Ø 3,0 mm 17-34-110-30
 Ø 3,5 mm 17-34-110-35
 Ø 4,0 mm 17-34-110-40
 Ø 4,5 mm 17-34-110-45
 Ø 5,0 mm 17-34-110-50
 Ø 5,5 mm 17-34-110-55
 Ø 6,0 mm 17-34-110-60

STANDARD
11,0 cm, 4 3/4"



Ø 3,0 mm 17-34-112-30
 Ø 3,5 mm 17-34-112-35
 Ø 4,0 mm 17-34-112-40
 Ø 4,5 mm 17-34-112-45
 Ø 5,0 mm 17-34-112-50
 Ø 5,5 mm 17-34-112-55
 Ø 6,0 mm 17-34-112-60

STANDARD
12,0 cm, 4 3/4"



Ø 3,0 mm 17-34-114-30
 Ø 3,5 mm 17-34-114-35
 Ø 4,0 mm 17-34-114-40
 Ø 4,5 mm 17-34-114-45
 Ø 5,0 mm 17-34-114-50
 Ø 5,5 mm 17-34-114-55
 Ø 6,0 mm 17-34-114-60

STANDARD
12,0 cm, 4 3/4"



Ø 7,3 mm 17-34-118-07
 Ø 8,7 mm 17-34-118-09
 Ø 12,0 mm 17-34-118-12

HURWITZ



Ø 4,5 mm
 Ø 3,0 mm
 Ø 1,75 mm

UNIVERSAL
17-34-100-03



Ø 6,0 mm
 Ø 4,5 mm

Ø 3,0 mm
 Ø 1,75 mm

UNIVERSAL
17-34-100-04

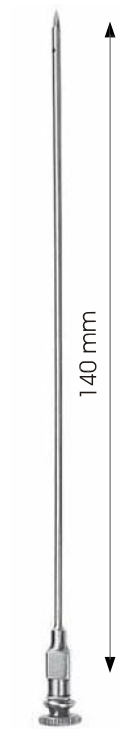

LANDAU
Ø 2,0 mm
17-33-160-16



LANDAU
Ø 2,0 mm
17-33-161-16



DAVIDSON
Ø 6,0 mm
17-33-164-18



BUELAU
Ø 6,0 mm 17-33-124-23
Ø 8,0 mm 17-33-124-24
Ø 10,0 mm 17-33-124-25



LERMOYEZ

Ø 2,0 mm 17-34-130-20
Ø 2,5 mm 17-34-130-25
Ø 3,0 mm 17-34-130-30



CAMPBELL
16,0 cm, 6¼"

Ø 6,0 mm 17-34-128-06
Ø 8,0 mm 17-34-128-08



NELSON
21,0 cm, 8½"

Ø 7,5 mm 17-34-120-01
Ø 9,0 mm 17-34-120-02
Ø 11,0 mm 17-34-120-03
Ø 12,5 mm 17-34-120-04

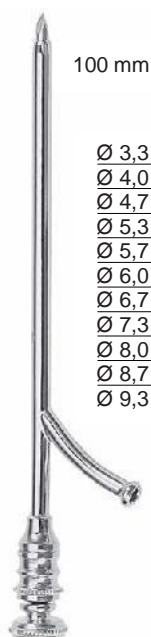

100 mm

Ø 3,3 mm 17-34-140-01
Ø 4,0 mm 17-34-140-02
Ø 4,7 mm 17-34-140-03
Ø 5,3 mm 17-34-140-04
Ø 5,7 mm 17-34-140-05
Ø 6,0 mm 17-34-140-06
Ø 6,7 mm 17-34-140-07
Ø 7,3 mm 17-34-140-08
Ø 8,0 mm 17-34-140-09
Ø 8,7 mm 17-34-140-10
Ø 9,3 mm 17-34-140-11

OCHSNER
14,0 cm, 5½"



PIERCE
16,0 cm, 6¼"

Ø 3,0 mm 17-34-180-30
Ø 4,0 mm 17-34-180-40
Ø 5,0 mm 17-34-180-50



Ø 2,5 mm

COAKLEY
14,0 cm, 5¼"
17-34-190-14



KRAUSE
16,0 cm, 6¼"

LICHTWITZ
Kieferhöhlentrokare
Antrum trocars
maxillaire troglodytique Trocars
Trócares para el seno maxilar
Троакар для полостей

Ø 3,0 mm 17-34-184-30
Ø 4,0 mm 17-34-184-40
Ø 5,0 mm 17-34-184-50
Ø 5,5 mm 17-34-184-55

Ø 1,8 mm



LICHTWITZ
20,0 cm, 8"
17-34-170-00

LICHTWITZ
11,0 cm 4¼"
Ø 1,6 cm 17-34-172-16
Ø 1,8 cm 17-34-172-18



DOUGLAS
Ø 3,0 mm
1734-175-00



POOLE

L 190 mm Ø 15,5 mm 17-35-020-06
L 245 mm Ø 18,0 mm 17-35-020-08
L 235 mm Ø 10,0 mm 17-35-020-10



POOLE

L 190 mm Ø 10,0 mm 17-35-020-10
L 245 mm Ø 18,0 mm 17-35-021-08
L 235 mm Ø 10,0 mm 17-35-021-10

Saugrohre Suction
 Tubes Tubes
 d'aspiration
 Tubos para aspiración
 Отсасывающие трубки

auswechselbare Spitze
 interchangeable tip
 Pointe de succion
 Punta intercambiables
 сменный наконечник



- Ø 1,5 mm 17-35-010-15
- Ø 1,9 mm 17-35-010-19
- Ø 2,3 mm 17-35-010-23
- Ø 2,8 mm 17-35-010-28

COUPLAND
 16,5cm, 6³/₄"
 17-35-010-17



YANKAUER

17-35-000-00



Olive allein
 Olive only
 Olive seul
 Oliva suelto
 только олива

- Ø 1,8 mm 17-35-000-18
- Ø 2,0 mm 17-35-000-20
- Ø 4,8 mm 17-35-000-48



DE BAKEY
 27,0 cm, 10⁵/₈"
 17-35-008-27



ANTHONY
 26,0 cm, 10¹/₄"
 17-35-007-26



ANDREWS-PYNCHON
 24,0 cm, 9¹/₂"

- Ø 2,3 mm
- Ø 3,0 mm 17-35-006-30
 - Ø 4,0 mm 17-35-006-40
 - Ø 6,0 mm 17-35-006-60



COGSWELL
 23,0 cm, 9"
 17-35-014-23



ADSON
 21,0 cm, 8¹/₄"

- Charr. 10 17-35-050-10
- Charr. 11 17-35-050-11
- Charr. 12 17-35-050-12
- Charr. 14 17-35-050-14
- Charr. 15 17-35-050-15



COOLEY
 33,0 cm, 13", Ø 8,0 mm
 17-35-024-01



COOLEY
 35,0 cm, 13¾", Ø 8,0 mm
 17-35-024-02



COOLEY
 30,0 cm, 11¾", Ø 7,0 mm
 17-35-024-03



COOLEY
 31,0 cm, 12¾", Ø 10,0 mm
 17-35-024-04



Ø 1,5 mm 17-35-012-15
 Ø 2,5 mm 17-35-012-25
 Ø 3,5 mm 17-35-012-35

BYRD
 15,0 cm, 8"



HEPP/SCHIEDEL
 22,5 cm, 8¾"
 17-35-016-22



Ø 1,0 mm 17-35-060-01
 Ø 2,0 mm 17-35-060-02
 Ø 3,0 mm 17-35-060-03
 Ø 3,5 mm 17-35-060-35
 Ø 4,0 mm 17-35-060-04

MAGILL
 17,5 cm, 6⅝"
 17-35-060-05



45°

L=100 mm

| | |
|-----------|---------------------|
| Charr. 3 | <u>17-35-030-03</u> |
| Charr. 4 | <u>17-35-030-04</u> |
| Charr. 5 | <u>17-35-030-05</u> |
| Charr. 6 | <u>17-35-030-06</u> |
| Charr. 7 | <u>17-35-030-07</u> |
| Charr. 8 | <u>17-35-030-08</u> |
| Charr. 9 | <u>17-35-030-09</u> |
| Charr. 10 | <u>17-35-030-10</u> |
| Charr. 11 | <u>17-35-030-11</u> |
| Charr. 12 | <u>17-35-030-12</u> |
| Charr. 14 | <u>17-35-030-14</u> |
| Charr. 15 | <u>17-35-030-15</u> |

L=130 mm

| | |
|-----------|---------------------|
| Charr. 3 | <u>17-35-031-03</u> |
| Charr. 4 | <u>17-35-031-04</u> |
| Charr. 5 | <u>17-35-031-05</u> |
| Charr. 6 | <u>17-35-031-06</u> |
| Charr. 7 | <u>17-35-031-07</u> |
| Charr. 8 | <u>17-35-031-08</u> |
| Charr. 9 | <u>17-35-031-09</u> |
| Charr. 10 | <u>17-35-031-10</u> |
| Charr. 11 | <u>17-35-031-11</u> |
| Charr. 12 | <u>17-35-031-12</u> |
| Charr. 14 | <u>17-35-031-14</u> |
| Charr. 15 | <u>17-35-031-15</u> |

L=180 mm

| | |
|-----------|---------------------|
| Charr. 3 | <u>17-35-032-03</u> |
| Charr. 4 | <u>17-35-032-04</u> |
| Charr. 5 | <u>17-35-032-05</u> |
| Charr. 6 | <u>17-35-032-06</u> |
| Charr. 7 | <u>17-35-032-07</u> |
| Charr. 8 | <u>17-35-032-08</u> |
| Charr. 9 | <u>17-35-032-09</u> |
| Charr. 10 | <u>17-35-032-10</u> |
| Charr. 11 | <u>17-35-032-11</u> |
| Charr. 12 | <u>17-35-032-12</u> |
| Charr. 14 | <u>17-35-032-14</u> |
| Charr. 15 | <u>17-35-032-15</u> |

FRAZIER
 19,0 cm, 7½"



60°

| | |
|-----------|---------------------|
| Charr. 3 | <u>17-35-033-03</u> |
| Charr. 4 | <u>17-35-033-04</u> |
| Charr. 5 | <u>17-35-033-05</u> |
| Charr. 6 | <u>17-35-033-06</u> |
| Charr. 7 | <u>17-35-033-07</u> |
| Charr. 8 | <u>17-35-033-08</u> |
| Charr. 9 | <u>17-35-033-09</u> |
| Charr. 10 | <u>17-35-033-10</u> |
| Charr. 11 | <u>17-35-033-11</u> |
| Charr. 12 | <u>17-35-033-12</u> |
| Charr. 14 | <u>17-35-033-14</u> |
| Charr. 15 | <u>17-35-033-15</u> |

FERGUSSON
 11,0 cm, 7"



75°

| | |
|-----------|---------------------|
| Charr. 3 | <u>17-35-034-03</u> |
| Charr. 4 | <u>17-35-034-04</u> |
| Charr. 5 | <u>17-35-034-05</u> |
| Charr. 6 | <u>17-35-034-06</u> |
| Charr. 7 | <u>17-35-034-07</u> |
| Charr. 8 | <u>17-35-034-08</u> |
| Charr. 9 | <u>17-35-034-09</u> |
| Charr. 10 | <u>17-35-034-10</u> |
| Charr. 11 | <u>17-35-034-11</u> |
| Charr. 12 | <u>17-35-034-12</u> |
| Charr. 14 | <u>17-35-034-14</u> |
| Charr. 15 | <u>17-35-034-15</u> |

POPPE
 11,0 cm, 5"



Packung zu 12 Stück
 Package of 12 pcs.
 Raccord unité a 12 pièces
 Cajecita de 12 pzs.
 упаковка из 12 шт.

- Ø 0,90 x 38 mm 17-36-000-01
- Ø 0,80 x 32 mm 17-36-000-02
- Ø 0,70 x 32 mm 17-36-000-03
- Ø 0,65 x 28 mm 17-36-000-04
- Ø 0,60 x 25 mm 17-36-000-05
- Ø 0,50 x 23 mm 17-36-000-06
- Ø 0,45 x 20 mm 17-36-000-07

LUER-LOCK



17-36-150-01

Nadel
 Needle
 Canule
 Aguja
 Игла

IOWA
 14,0 cm, 5 1/4"
 17-36-150-14

MOCK
 6,0 cm, 3/4"
 17-36-200-06



Kanülen zur Sternalpunktion
 Sternum puncture needles
 Aiguille pour ponction sternal
 Agujas para la punción del esternón
 Иглы для грудной пункции

| Ø mm | L | | | Ø | L | | | |
|------|----|----|----|------|----|--------|--------|--------------|
| 1,80 | 25 | 35 | 50 | 15 G | 1" | 1 1/2" | 2" | 17-36-060-16 |
| 2,00 | 25 | 35 | 70 | 14 G | 1" | 1 1/2" | 2 3/4" | 17-36-060-18 |
| 2,50 | 25 | 35 | 70 | 13 G | 1" | 1 1/2" | 2 3/4" | 17-36-060-20 |
| 2,80 | 25 | 35 | 80 | 12 G | 1" | 1 1/2" | 3 1/4" | 17-36-060-22 |
| 3,00 | 25 | 35 | | 11 G | 1" | 1 1/2" | | 17-36-060-24 |

KLIMA-ROSSEGGGER - MARK Luer Lock



Ø 1,20 x 80 mm 17-36-210-12
 Ø 1,50 x 80 mm 17-36-210-15



Ø 2,1 x 80 mm 17-36-180-08
 Ø 2,1 x 100 mm 17-36-180-10
 Ø 2,1 x 120 mm 17-36-180-12
 Ø 2,1 x 150 mm 17-36-180-15
 Ø 2,1 x 170 mm 17-36-180-17
 Ø 2,1 x 200 mm 17-36-180-20

VERESS



RÖNGEN / RADIOGRAPHIE / RÖNGENOGRAPHY /
 Röntgen / ренген Arteriographie und perkutane
 Gefäßkaterisierung
 Arteriography and percutaneousvascular catheterisation

SELDINGER-STILLE Luer Lock (A+B)

P 1

| Ø mm | L mm | Ø mm | L | |
|------|------|------|---------------------------------|--------------|
| 1,40 | 70 | 18 G | 2 ³ / ₄ " | 17-36-650-14 |
| 1,40 | 100 | 18 G | 4" | 17-36-051-14 |

SELDINGER Double Luer Lock(A+B+C)

P 2

| Ø mm | L mm | Ø mm | L | |
|------|------|------|---------------------------------|--------------|
| 1,40 | 70 | 18 G | 2 ³ / ₄ " | 17-36-652-14 |
| 1,40 | 100 | 18 G | 4" | 17-36-053-14 |

SELDINGER- Luer Lock (A+B)

P 3

| Ø mm | L mm | Ø mm | L | |
|------|------|------|---------------------------------|--------------|
| 2,00 | 70 | 14 G | 2 ³ / ₄ " | 17-36-650-20 |
| 2,00 | 100 | 14 G | 4" | 17-36-051-20 |

SELDINGER Double Luer Lock(A+B+C)

P 4

| Ø mm | L mm | Ø mm | L | |
|------|------|------|---------------------------------|--------------|
| 2,00 | 70 | 14 G | 2 ³ / ₄ " | 17-36-652-20 |
| 2,00 | 100 | 14 G | 4" | 17-36-053-20 |

ARTERIOGRAPHY LUER LOCK(A+B+C+D)

| Ø mm | L mm | Ø mm | L | |
|------|------|------|---------------------------------|--|
| 1,10 | 70 | 19 G | 2 ³ / ₄ " | 17-36-654-11 |
| 1,10 | 100 | 19 G | 4" | 17-36-055-11 |
| 1,40 | 70 | P 1 | 18 G | 2 ³ / ₄ " 17-36-650-14 |
| 1,40 | 100 | P 1 | 18 G | 4" 17-36-051-14 |
| 1,65 | 70 | 16 G | 2 ³ / ₄ " | 17-36-654-16 |
| 1,65 | 100 | 16 G | 4" | 17-36-055-16 |
| 2,00 | 70 | P 4 | 14 G | 2 ³ / ₄ " 17-36-652-20 |
| 2,00 | 100 | P 4 | 14 G | 4" 17-36-053-20 |

P1; P3

P2; P4

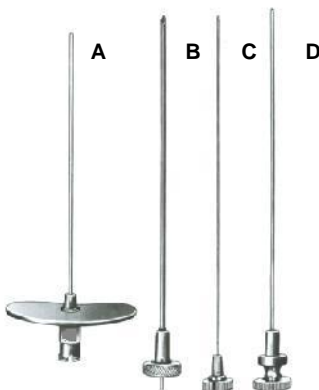

SELDINGER



Kanülen zur Lumbalpunktion
 Lumbar puncture needles
 Aiguille pour ponction lombare
 Aguja para punción lumbar
 Иглы для поясничной пункции

| Ø mm | L mm | | | | | Ø mm | L | | | | | |
|------|------|----|----|-----|-----|------|-----|-----|-----|----|-----|--------------|
| 0,80 | 70 | 80 | 90 | 100 | 120 | 21 G | 2¾" | 3¼" | 3½" | 4" | 4¾" | 17-36-130-01 |
| 1,00 | 70 | 80 | 90 | 100 | 120 | 19 G | 2¾" | 3¼" | 3½" | 4" | 4¾" | 17-36-130-02 |
| 1,20 | 70 | 80 | 90 | 100 | 120 | 18 G | 2¾" | 3¼" | 3½" | 4" | 4¾" | 17-36-130-03 |
| 1,40 | 70 | 80 | 90 | 100 | 120 | 17 G | 2¾" | 3¼" | 3½" | 4" | 4¾" | 17-36-130-04 |
| 1,60 | 70 | 80 | 90 | 100 | 120 | 16 G | 2¾" | 3¼" | 3½" | 4" | 4¾" | 17-36-130-05 |
| 1,80 | 70 | 80 | 90 | 100 | 120 | 15 G | 2¾" | 3¼" | 3½" | 4" | 4¾" | 17-36-130-06 |
| 2,00 | 70 | 80 | 90 | 100 | 120 | 14 G | 2¾" | 3¼" | 3½" | 4" | 4¾" | 17-36-130-07 |

BARKER BIER LUER LOCK

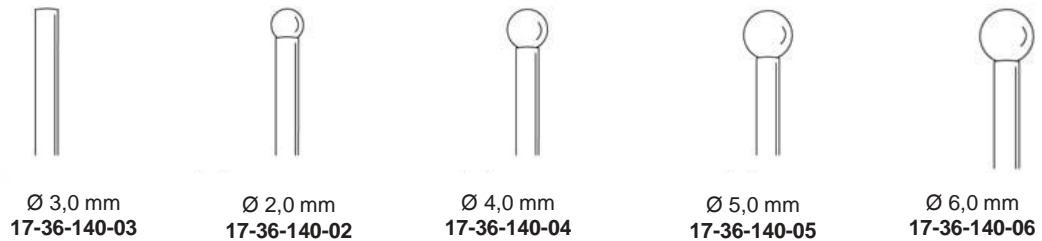

Gefäßspülkanülen, biegsam
 Vascular irrigation cannulae, malleable
 Malléable raccord Luer-Lock argent, malléable
 Cánulas vasculares para irrigación, maleables
 Сосудистая ирригационная канюля, изгибаемая

SCHMID
 15,0 cm, 6"

Kanülen zur Lumbalpunktion
 Lumbar puncture needles
 Aiguille pour ponction lombare
 Agujas para punción lumbar
 Иглы для поясничной пункции



Ø 1,20 x 76 mm 17-36-120-01
Ø 1,20 x 89 mm 17-36-120-02
Ø 1,00 x 76 mm 17-36-120-03
Ø 1,00 x 89 mm 17-36-120-04
Ø 0,70 x 76 mm 17-36-120-05
Ø 0,70 x 50 mm 17-36-120-06
Ø 0,70 x 89 mm 17-36-120-07

QUINKE

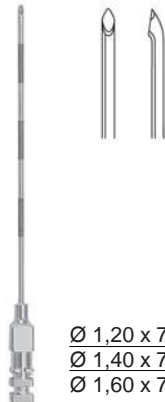

Ø 1,20 x 76 mm 17-36-090-12
Ø 1,40 x 76 mm 17-36-090-14
Ø 1,60 x 76 mm 17-36-090-16

TUOHY

Kanülen zur Leberblindpunktion
 Liver blind puncture needles
 Aiguille pour ponction aveugle du foie
 Agujas para punción ciega del hígado
 Иглы для пункции печени



Ø 1,00 x 35 mm 17-36-115-01
Ø 1,00 x 70 mm 17-36-115-02
Ø 1,20 x 70 mm 17-36-115-03
Ø 1,20 x 100 mm 17-36-115-04
Ø 1,40 x 70 mm 17-36-115-05
Ø 1,40 x 100 mm 17-36-115-06
Ø 1,60 x 70 mm 17-36-115-07
Ø 1,60 x 100 mm 17-36-115-08

MENGHINI

Kanülen zur gezielten Leberpunktion
 Needles for controlled liver puncture
 Agujas para la punción del hígado bajo el
 Aiguille pour ponction contrôlée du foie
 Control laparoscópio
 Иглы для пункции печени под контролем



Ø 1,40 x 168 mm 17-36-117-14
Ø 1,80 x 168 mm 17-36-117-18

MENGHINI

Trokare für Kanülen
 Trocars for needles
 Trocarts pour aiguille
 Trocares para agujas
 Троакары для игл



Ø 1,40 x 168 mm 17-36-230-14
Ø 1,80 x 168 mm 17-36-230-18



17-37-911-00

Verbindungsstück, LUER-LOCK weiblich, LUER-LOCK männlich
Adapter female-LUER LOCK / male LUER-LOCK Raccords,
LUER LOCK femelle / Luer-Lock male Соединительная
деталь, замок Луер мама; замок Луер папа



17-37-912-00

Verbindungsstück, LUER-LOCK männlich / weiblich RECORD
Adapter male -LUER / female RECORD
Raccords, RECORD femelle/ LUER LOCK male
Соединительная деталь, замок Луер папа, замок RECORD
мама



17-37-910-00

Verbindungsstück, LUER-LOCK weiblich/RECORD männlich
Adapter female-LUER LOCK / male RECORD Raccords,
RECORD femelle / LUER LOCK male Соединительная
деталь, замок Луер мама; RECORD папа



17-37-913-00

Verbindungsstück, 2 x LUER-LOCK, weiblich
Adapter 2 x female-LUER LOCK Raccords, 2 x
LUER LOCK femelle Соединительная деталь,
2 x замок Луер мама



17-37-914-00

Verbindungsstück, 2 x LUER-LOCK weiblich, mit Gewinde
Adapter 2 x female-LUER LOCK, with thread Raccords, 2 x
LUER LOCK femelle avec filet intérieur Соединительная
деталь, 2 x замок Луер мама, с резьбой



17-37-915-00

Verbindungsstück, 2 x LUER-LOCK männlich
Adapter 2 x male -LUER LOCK Raccords 2 x
LUER LOCK male Соединительная деталь, 2
x замок Луер папа



17-37-916-00

Verbindungsstück 2x LUER männlich
Adapter 2x male LUER
Raccords 2 x LUER male
Соединительная деталь, 2 x замок Луер папа



17-37-917-00

Verbindungsstück LUER LOCK männlich / LUER LOCK weiblich
Adapter male LUER LOCK / female LUER LOCK Raccords,
LUER LOCK femelle / LUER LOCK male Соединительная
деталь, замок Луер папа, замок Луер мама



Ø 4,00 **17-37-918-04**

Ø 5,00 **17-37-918-05**

Ø 6,00 **17-37-918-06**

Ø 7,00 **17-37-918-07**

Ø 8,00 **17-37-918-08**

Ø 10,0 **17-37-918-10**

Schlauchverbinder LUER LOCK männlich
Tube connector male LUER LOCK
Raccords, LUER LOCK male
Соединительная деталь замок Луер папа



Ø 4,00 **17-37-919-04**

Ø 5,00 **17-37-919-05**

Ø 6,00 **17-37-919-06**

Ø 7,00 **17-37-919-07**

Ø 8,00 **17-37-919-08**

Ø 10,0 **17-37-919-10**

Verbindungsstück LUER LOCK weiblich
Tube connector female LUER LOCK
Raccords, LUER LOCK femelle
Соединительная деталь, замок Луер мама



17-37-920-00

Dreiwegehahn LUER LOCK weiblich / 2 x LUER LOCK männlich
Three-way stopcock female LUER LOCK / 2 x male LUER LOCK
Robinet a trois voies 1 x femelle, 2 x male / Llave de 3 vias 1 x hembra 2 x macho / Запорный кран с тремя выходами, 1 x замок Луер мама, 2 x замка папа



17-37-922-00

Dreiwegehahn 2 x LUER LOCK weiblich / LUER LOCK männlich
Three-way stopcock 2 x female LUER LOCK / male LUER LOCK
Robinet a trois voies 2 x femelle, 1 x male / Llave de 3 vias 2 x hembra 1 x macho / Запорный кран с тремя выходами, 2 x замка Луер мама, 1 x замок папа



17-37-926-00

Federschraubkappe
Spring screw cap
Ressort bouchon filete.
Пружинная закручиваемая головка



17-37-930-01

Durchflusshahn LUER LOCK männlich / LUER LOCK weiblich
One-way stopcock male LUER LOCK / female LUER LOCK
Robinet femelle / male / Llave 1 x hembra, 1 x macho /
Запорный кран, 1 x замок Луер мама / 1 x замок Луер папа



17-37-930-02

Durchflusshahn LUER männlich / LUER LOCK weiblich
One-way stopcock male LUER / female LUER LOCK
Robinet femelle / male Llave 1 x hembra, 1x macho /
Запорный кран, 1 x замок Луер папа / 1x замок Луер мама



17-37-930-03

Durchflusshahn LUER männlich / LUER LOCK weiblich, mit Gewinde
One-way stopcock male LUER LOCK / female LUER LOCK, with thread
Robinet femelle / male Llave 1 x hembra, 1 x macho /
Запорный кран, 1 x замок Луер мама с резьбой / 1 x замок Луер папа



17-37-935-00

Durchflusshahn LUER männlich / LUER LOCK weiblich
One-way stopcock male LUER / female LUER LOCK
Robinet femelle / male/ Llave 1 x hembra, 1 x macho /
Запорный кран, 1 x замок Луер папа / 1 x замок Луер мама



17-37-939-00

Durchflusshahn LUER männlich / LUER LOCK weiblich, mit Gewinde
One-way stopcock male LUER LOCK / female LUER LOCK, with thread
Robinet femelle / male / Llave hembra / macho /
Запорный кран, замок Луер мама с резьбой / замок Луер папа



17-37-940-00

Dreiwegehahn LUER LOCK 2 x weiblich / 1 x LUER LOCK männlich
Three-way stopcock 2x female LUER LOCK / 1 x male LUER LOCK
Robinat a trois voies 2 x femelle, 1 x male / Llave de 3 vias 2 x hembra 1 x macho / Запорный кран с тремя выходами, 2 x замок Луер мама, 1 x замка папа



17-37-941-00

Durchflusshahn LUER weiblich / LUER LOCK weiblich,
One-way stopcock female LUER LOCK / female LUER LOCK,
Robinet femelle / femelle / Llave hembra / hembra /
Запорный кран, замок Луер мама с резьбой / замок Луер папа



17-37-942-00

Saug- und Spülgriff, mit doppeltem Trompetenventil, Schlauchansatz Ø 7 u. 12 mm
 Suction and irrigation handle, with double trumpet valve, hose end Ø 7 a. 12 mm
 Poignée d'aspiration, laver, tubes Ø 7 u. 12 mm
 Manipolador aspirante, lavar, tubos Ø 7 u. 12 mm
 Ручка для отсасывания и промывания, с двойным трюмбетным клапаном, для трубок Ø 7 и 12 мм



17-37-943-00

Saug- und Spülgriff,
 Suction and irrigation handle,
 Poignée d'aspiration, laver
 Manipolador aspirante, lavar
 Ручка для отсасывания и промывания



17-37-944-00

Ø 5 x 330 mm
 Saug- und Spülrohr,
 Suction and irrigation tube,
 Tubes d'aspiration, laver
 Tubos para aspiración, lavar
 Трубки для отсасывания и промывания



17-37-945-00

Ø 10 x 330 mm Saug- und
 Spülrohr, Suction and
 irrigation tube, Tubes
 d'aspiration, laver
 Tubos para aspiración, lavar
 Трубки для отсасывания и промывания



17-37-946-00

Ø 5 x 450 mm
 Saug- und Spülrohr, mit 2x Hähnen
 Suction and irrigation tube, w. 2x stopcocks
 Tubes d'aspiration, laver, 2x Robinets
 Tubos para aspiración, lavar 2x Llaves
 Трубки для отсасывания и промывания с 2мя кранами



17-37-947-00

Ø 5 x 330 mm
 Saug- und Spülrohr, mit 2x Trompetenventil
 Suction and irrigation tube, w. 2x trumpet valve
 Tubes d'aspiration, laver 2x valva
 Tubos para aspiración, lavar, 2 x valva
 Трубки для отсасывания и промывания с 2 x трюмбетными клапанами



ПТП МЕДТЕХНИКА

**Galle, Leber, Niere, Blase, Urologie
Gall, Liver, Kidney, Bladder, Urology
Vésicule biliaire, Foie, Rion, Bulle, Urologie
Bilis, Hígado, Riñon, Vejiga, Urología
Желчный пузырь, печень, почки,
Мочевой пузырь, урология**



Nierensteinzangen, Gallensteinzangen
Kidney Stone Forceps, Gall Stone Forceps
Pinces pour calculs rénaux, Pinces pour calculs biliaires
Pinzas para cálculos renales, Pinzas para cálculos biliares
Зажимы для почечных камней, зажимы для желчных камней

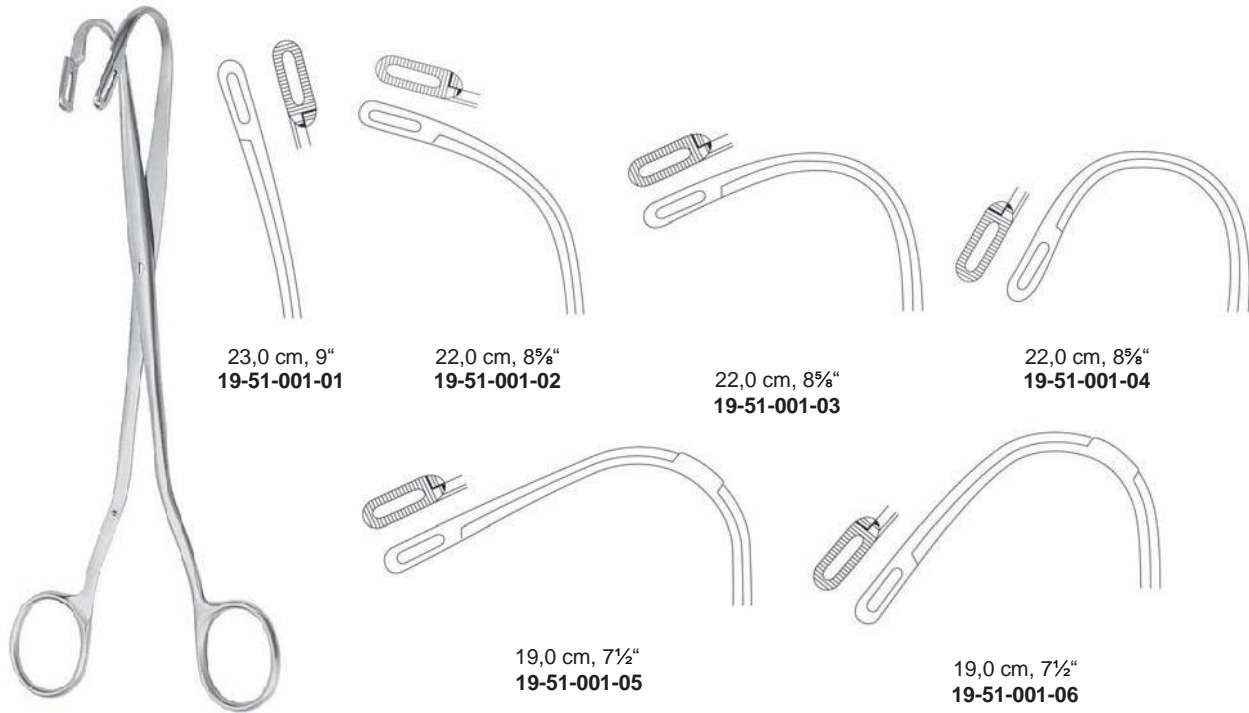

RANDALL

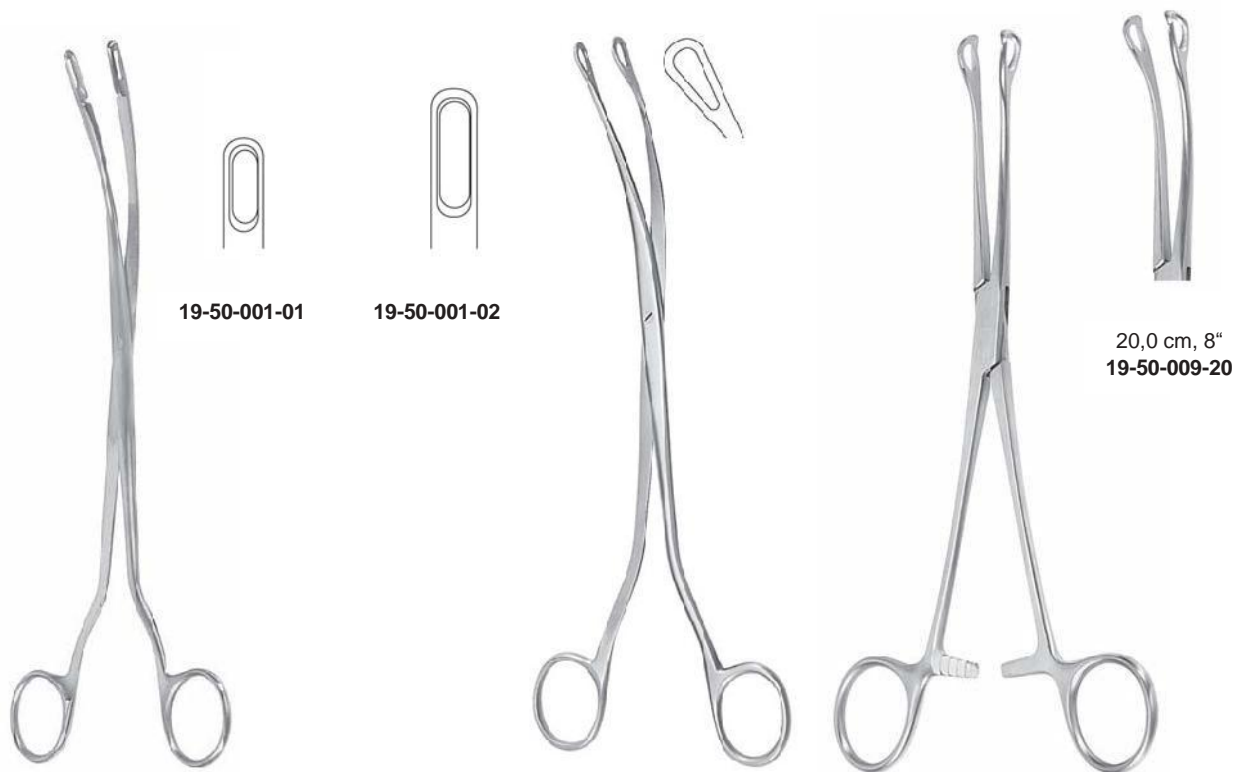

DESJARDINS
23,0 cm

MIXTER
22,0 cm, 8⁵/₈"
19-50-021-22

MAYO BLAKE
20,0 cm, 8"
19-50-008-20



BLAKE
20,0 cm, 8"
19-50-006-20

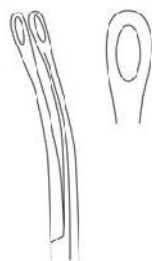

20,0 cm, 8"
19-50-005-20



TURNER-WARWICK
18,0 cm, 7"

19-50-031-01



19-50-031-03



CZERNY
24,5 cm, 9 5/8"
19-50-039-24

Gallensteinlöffel
 Gall Stone Scoops
 Curettes pour calculs biliaires
 Cucharillas para los cálculos biliares
 Ложки для желчных камней



Schaft biegsam
 shaft malleable
 Tige malléable
 Tige malleable
 Гнущийся стержень

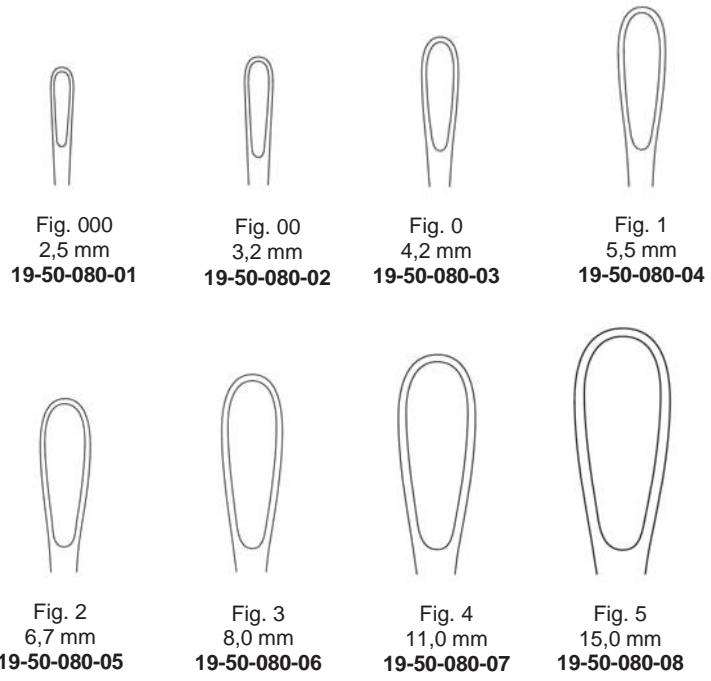

LUER-KÖRTE
 27,0 cm, 10 $\frac{3}{4}$ "



FERGUSSON
 21,5 cm, 8 $\frac{1}{2}$ "
 19-50-070-01



MAYO
 27,0 cm, 10 $\frac{3}{8}$ "
 19-50-072-01



MAYO
 27,0 cm, 10 $\frac{3}{8}$ "



19-50-074-01

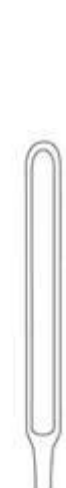

19-50-074-02



19-50-074-03



MOYNIHAN
 34,0 cm, 13 $\frac{3}{8}$ "
 19-50-076-34

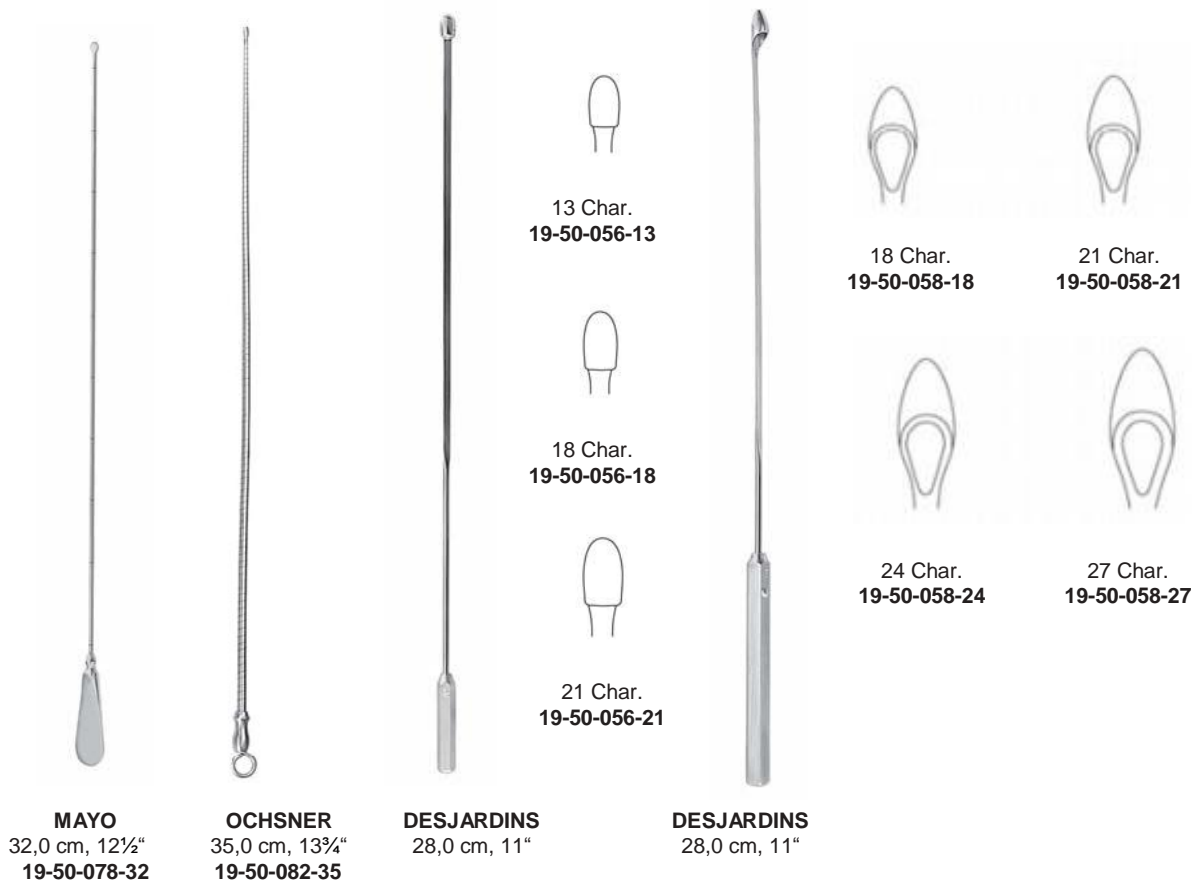

Gallensteinlöffel
Cuillère a calculs biliaires
Gall Stone Scoops
Cucharillas para los cálculos biliares
Ложки для желчных камней

MOORE
 30,0 cm, 12"
 19-50-084-30

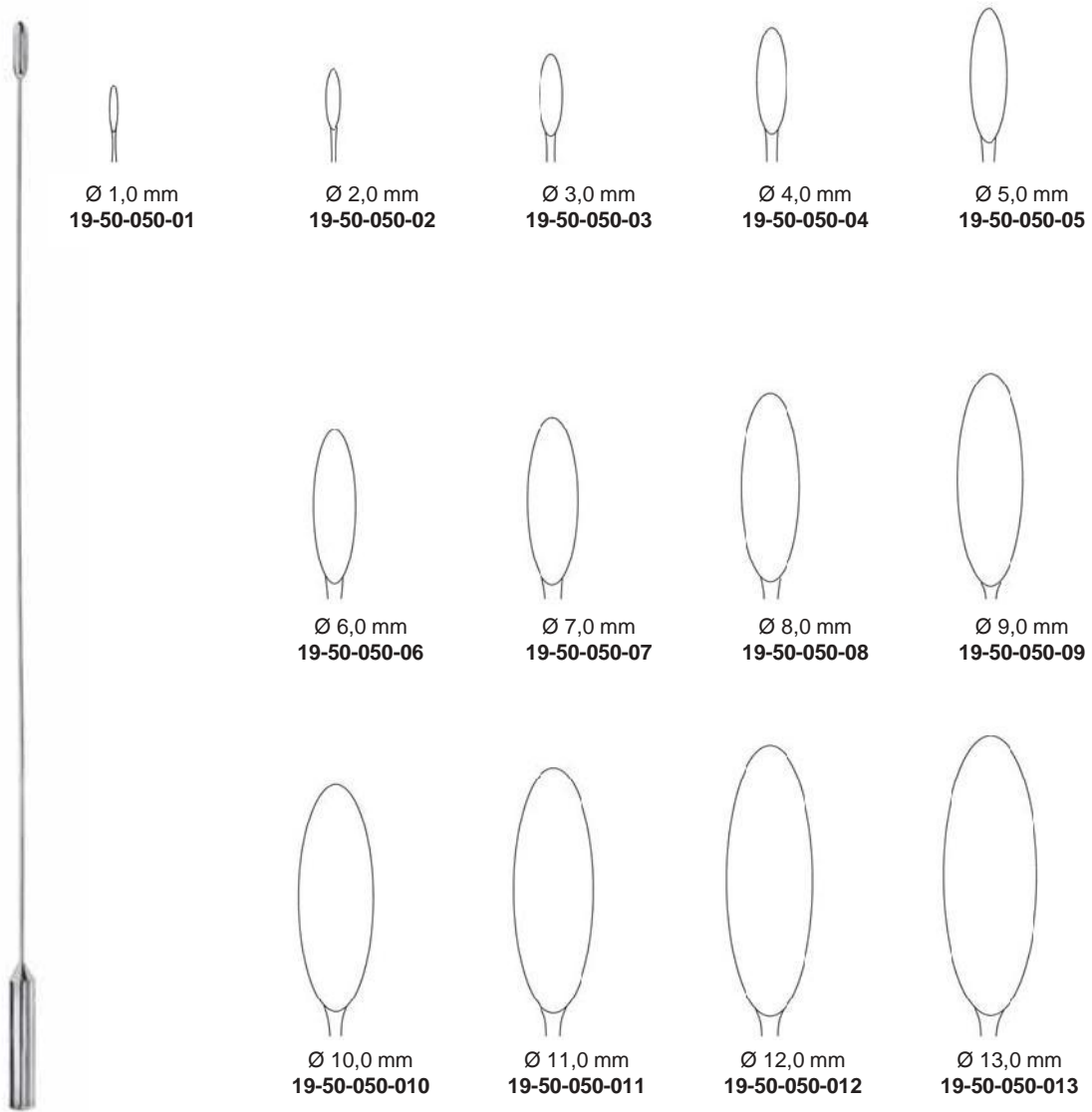

BAKES
30,0 cm, 11¾"



THOMSON-WALKER
 19-56-182-00

57 x 25 mm 19-56-176-03
 80 x 25 mm 19-56-176-04



MILLIN
 19-56-176-00
 komplett / complete / complet /
 completo / комплект



JUDD-MASSON
 19-56-172-00

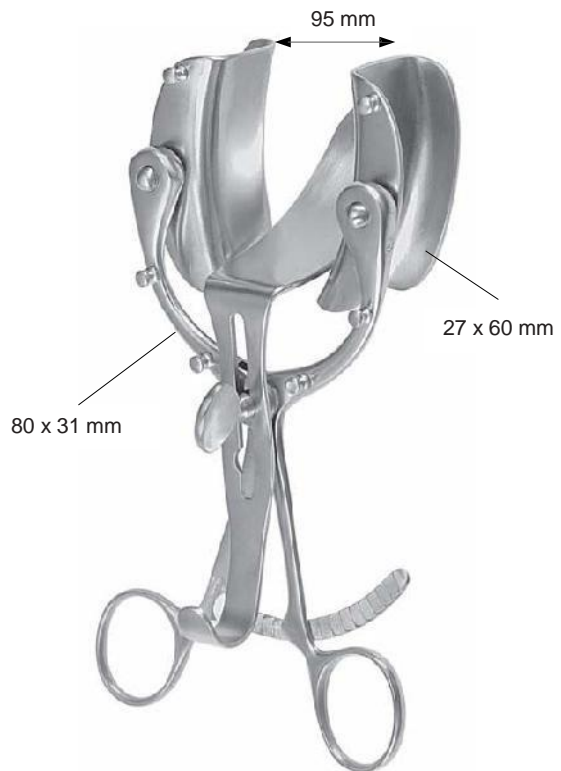

LEGUEU
 19-56-160-00



MILLIN
 23,0 cm, 9"
 19-56-073-23



ATRAUMA
MILLIN
 24,0 cm, 9½"
 19-56-071-24



MILLIN
 24,0 cm, 9½"
 19-56-077-24



MILLIN
 23,0 cm, 9"
 19-56-075-23



MILLIN
 28,5 cm, 11¼"
 19-56-150-28

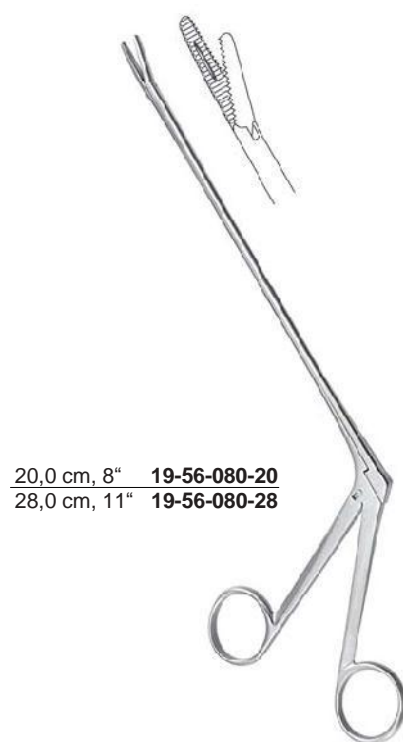

20,0 cm, 8" 19-56-080-20
 28,0 cm, 11" 19-56-080-28

MATHIEU



YOUNG
 21,0 cm, 8¼"
 19-56-230-21



YOUNG
 22,0 cm, 8⅝"
 19-56-236-22



YOUNG
 21,0 cm, 8¼"
 19-56-238-21

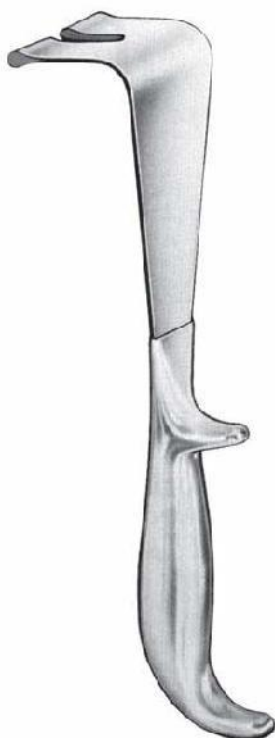

YOUNG
 22,0 cm, 8⅝"
 19-56-240-22



35 mm

LEGUEU
 27,0 cm, 10¼"
 19-56-250-27



67 mm

KOCHER
 26,0 cm, 10¼"
 19-56-257-26



van BUREN

Char. 6 [19-56-620-06](#)
Char. 8 [19-56-620-08](#)
Char. 10 [19-56-620-10](#)
Char. 12 [19-56-620-12](#)
Char. 14 [19-56-620-14](#)
Char. 16 [19-56-620-16](#)
Char. 18 [19-56-620-18](#)
Char. 20 [19-56-620-20](#)
Char. 22 [19-56-620-22](#)
Char. 24 [19-56-620-24](#)
Char. 26 [19-56-620-26](#)
Char. 28 [19-56-620-28](#)
Char. 30 [19-56-620-30](#)
Char. 32 [19-56-620-32](#)
Char. 34 [19-56-620-34](#)
Char. 36 [19-56-620-36](#)
Char. 38 [19-56-620-38](#)
Char. 40 [19-56-620-40](#)



29,0 cm, 11½"

für Männer
for men
pour hommes
para hombres
для мужчин

Char. 8 [19-56-650-08](#)
Char. 10 [19-56-650-10](#)
Char. 12 [19-56-650-12](#)
Char. 14 [19-56-650-14](#)
Char. 16 [19-56-650-16](#)
Char. 18 [19-56-650-18](#)
Char. 20 [19-56-650-20](#)
Char. 22 [19-56-650-22](#)
Char. 24 [19-56-650-24](#)



16,0 cm, 6¼"

für Frauen
for women
pour femmes
para mujeres
для женщин

Char. 8 [19-56-660-08](#)
Char. 10 [19-56-660-10](#)
Char. 12 [19-56-660-12](#)
Char. 14 [19-56-660-14](#)
Char. 16 [19-56-660-16](#)
Char. 18 [19-56-660-18](#)
Char. 20 [19-56-660-20](#)
Char. 24 [19-56-660-24](#)



DITTEL

Char. 8 [19-56-624-08](#)
Char. 10 [19-56-624-10](#)
Char. 12 [19-56-624-12](#)
Char. 14 [19-56-624-14](#)
Char. 16 [19-56-624-16](#)
Char. 18 [19-56-624-18](#)
Char. 20 [19-56-624-20](#)
Char. 22 [19-56-624-22](#)
Char. 24 [19-56-624-24](#)
Char. 26 [19-56-624-26](#)
Char. 28 [19-56-624-28](#)
Char. 30 [19-56-624-30](#)



COXETER

Char. 6 [19-56-614-06](#)
Char. 8 [19-56-614-08](#)
Char. 10 [19-56-614-10](#)
Char. 12 [19-56-614-12](#)
Char. 14 [19-56-614-14](#)
Char. 16 [19-56-614-16](#)
Char. 18 [19-56-614-18](#)
Char. 20 [19-56-614-20](#)
Char. 22 [19-56-614-22](#)
Char. 24 [19-56-614-24](#)



mit Schraubgewinde Ansatz
 with screw thread
 avec filet intérieur
 avec about filete
 с внутренней резьбой

- Char. 10 19-56-612-10
- Char. 12 19-56-612-12
- Char. 14 19-56-612-14
- Char. 16 19-56-612-16
- Char. 18 19-56-612-18
- Char. 20 19-56-612-20
- Char. 22 19-56-612-22
- Char. 24 19-56-612-24
- Char. 26 19-56-612-26
- Char. 28 19-56-612-28
- Char. 30 19-56-612-30



- Char. 6 19-56-610-06
- Char. 8 19-56-610-08
- Char. 10 19-56-610-10
- Char. 12 19-56-610-12
- Char. 14 19-56-610-14
- Char. 16 19-56-610-16
- Char. 18 19-56-610-18
- Char. 20 19-56-610-20
- Char. 22 19-56-610-22
- Char. 24 19-56-610-24
- Char. 26 19-56-610-26
- Char. 28 19-56-610-28
- Char. 30 19-56-610-30
- Char. 32 19-56-610-32
- Char. 34 19-56-610-34
- Char. 36 19-56-610-36
- Char. 38 19-56-610-38
- Char. 40 19-56-610-40

GUYON
 19-56-660-00
 komplett/ complete/ complet/
 completo/ комплект
 10-30 Char.

GUYON

Penisklemme
 Penis Clamp
 Pince pour pénis
 Clamp para pene
 Зажим для полового члена



STRAUSS
 11,0 cm, 4³/₈"
 19-56-349-11



STOCKMANN
 8,0 cm, 3¹/₄"
 19-56-345-08

- Ø 8,0 mm 19-56-350-08
- Ø 11,0 mm 19-56-350-11
- Ø 13,0 mm 19-56-350-13
- Ø 16,0 mm 19-56-350-16
- Ø 21,0 mm 19-56-350-21
- Ø 26,0 mm 19-56-350-26
- Ø 32,0 mm 19-56-350-32



COMCO

**Magen, Darm, Mastdarm
Stomach, Intestines, Rectum
Estomac, Intestin, Rectum
Estómagο, Intestino, Recto
Желудок, кишечник, прямая кишка**





4 : 5

13,0 cm, 5" 21-52-000-13
 14,0 cm, 5½" 21-52-000-14

ALLIS-BABY



4 : 5

16,0 cm, 6¾" 21-52-000-16
 19,0 cm, 7½" 21-52-000-19
 23,0 cm, 9" 21-52-000-23
 25,0 cm, 10" 21-52-000-25
 30,0 cm, 12" 21-52-000-30

5 : 6

16,0 cm, 6¾" 21-52-004-16
 19,0 cm, 7½" 21-52-004-19
 23,0 cm, 9" 21-52-004-23
 25,0 cm, 10" 21-52-004-25
 30,0 cm, 12" 21-52-004-30
 35,0 cm, 14" 21-52-004-35

ALLIS



16,0 cm, 6¼" 21-54-124-16
 20,0 cm, 8" 21-54-124-20
 25,0 cm, 9¾" 21-54-124-25
 30,0 cm, 11¾" 21-54-124-30

ALLIS-ATRAUMA



15,5 cm, 6" 21-52-020-15
 20,0 cm, 8" 21-52-020-20
 23,0 cm, 9" 21-52-020-23

ALLEN



12,5 cm, 5" **21-52-030-12**
 15,0 cm, 6" **21-52-030-15**
 19,5 cm, 7¾" **21-52-030-19**

LANE



16,0 cm, 6¼" **21-52-178-16**
 20,0 cm, 8" **21-52-178-20**

LOCKWOOD-ALLIS



16,0 cm, 6½" **21-52-040-16**
 20,0 cm, 8" **21-52-040-20**

JUDD-ALLIS



LITTLEWOOD
 18,5 cm, 7¼"
21-52-060-18



ALLIS-ADAIR
 15,5 cm, 6"
21-52-010-15

Darm- und Gewebefasszangen Intestinal
and Tissue Grasping Forceps Pincers a
saisir les intestins et les tissus Pinzas
intestinales y para tejidos Зажимы для
кишечника и тканей



BOYS-ALLIS
15,5 cm, 6"
21-52-012-15



THOMS-ALLIS
20,0 cm, 8"
21-52-050-20



ALLIS
20,0 cm, 8"
21-52-014-20



LOCKWOOD
20,0 cm, 8"
21-52-176-20



WILLIAMS
16,0 cm, 6¼"
21-52-070-16



16,0 cm, 6¼" **21-52-006-16**
 18,0 cm, 7" **21-52-006-18**
 20,0 cm, 8" **21-52-006-20**
 24,0 cm, 9½" **21-52-006-24**

BABCOCK



16,0 cm, 6¼" **21-54-006-16**
 20,0 cm, 8" **21-54-006-20**

BABCOCK-ATRAUMA



16,0 cm, 6¼" **21-53-006-16**
 20,0 cm, 8" **21-53-006-20**
 24,0 cm, 9½" **21-53-006-24**

BABCOCK-TC



DUVAL-TC
 20,0 cm, 8"
21-53-170-20

Darmklemmen
 Intestinal Clamp Forceps
 Pinces intestinales
 Pinzas-clamps intestinales
 Зажимы кишечные

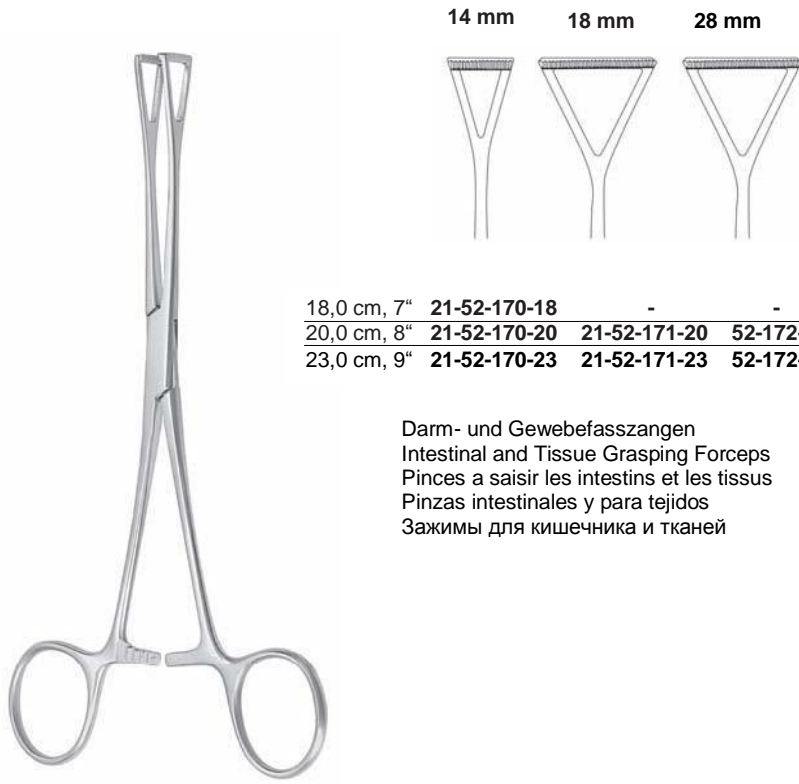

14 mm 18 mm 28 mm

| | | | |
|-------------|--------------|--------------|-----------|
| 18,0 cm, 7" | 21-52-170-18 | - | - |
| 20,0 cm, 8" | 21-52-170-20 | 21-52-171-20 | 52-172-20 |
| 23,0 cm, 9" | 21-52-170-23 | 21-52-171-23 | 52-172-23 |

Darm- und Gewebefasszangen
 Intestinal and Tissue Grasping Forceps
 Pinces a saisir les intestins et les tissus
 Pinzas intestinales y para tejidos
 Зажимы для кишечника и тканей

DUVAL

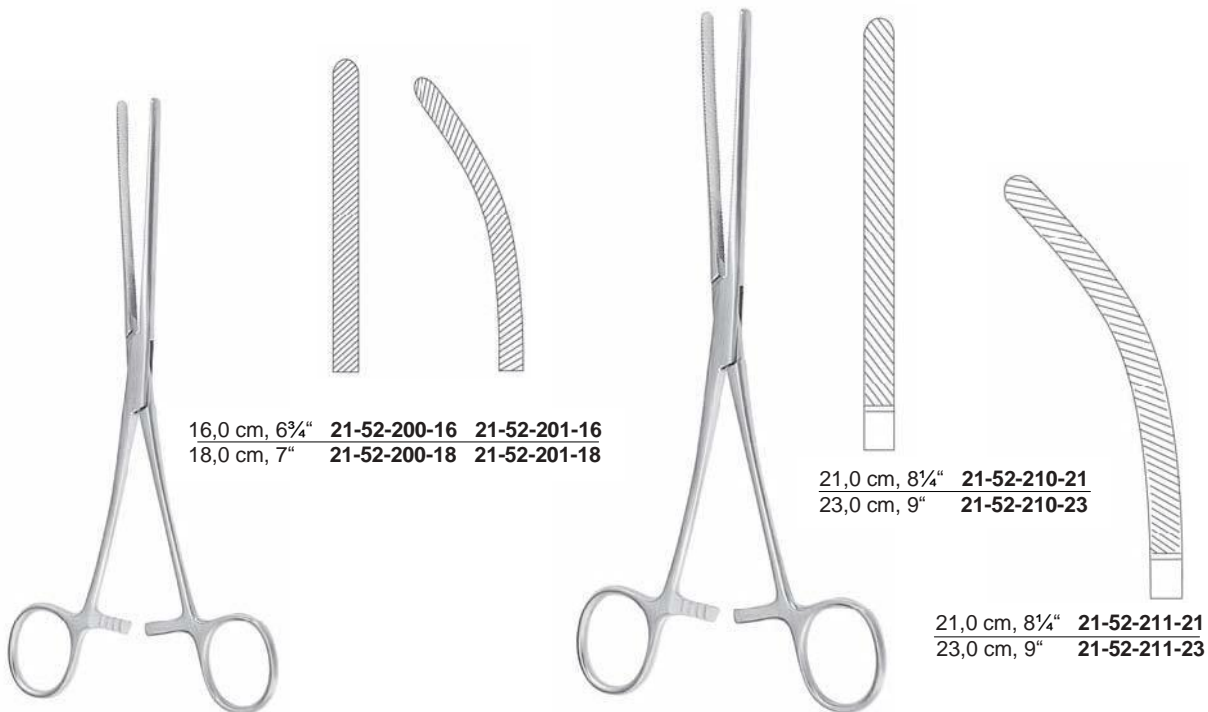

| | | |
|--|--------------|--------------|
| 16,0 cm, 6 ³ / ₄ " | 21-52-200-16 | 21-52-201-16 |
| 18,0 cm, 7" | 21-52-200-18 | 21-52-201-18 |

| | |
|--|--------------|
| 21,0 cm, 8 ¹ / ₄ " | 21-52-210-21 |
| 23,0 cm, 9" | 21-52-210-23 |

| | |
|--|--------------|
| 21,0 cm, 8 ¹ / ₄ " | 21-52-211-21 |
| 23,0 cm, 9" | 21-52-211-23 |

BABY-DOYEN
 18,0 cm, 7"

DOYEN



DOYEN

mit atraumatischer Zahnung
 with atraumatic serration
 atraumatiques
 con bacos atraumáticas
 с атравматичной зазубренностью

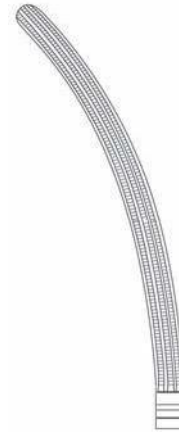

13,0 cm, 5" **21-54-210-13**
 16,0 cm, 6³/₄" **21-54-210-16**
 18,0 cm, 7" **21-54-210-18**
 21,0 cm, 8¹/₄" **21-54-210-21**
 23,0 cm, 9" **21-54-210-23**

13,0 cm, 5" **21-54-211-13**
 16,0 cm, 6³/₄" **21-54-211-16**
 18,0 cm, 7" **21-54-211-18**
 21,0 cm, 8¹/₄" **21-54-211-21**
 23,0 cm, 9" **21-54-211-23**



KOCHER



22,0 cm, 8⁵/₈" **21-52-234-22**
 25,0 cm, 9³/₄" **21-52-234-25**
 28,0 cm, 11" **21-52-234-28**

22,0 cm, 8⁵/₈" **21-52-235-22**
 25,0 cm, 9³/₄" **21-52-235-25**
 28,0 cm, 11" **21-52-235-28**



KOCHER

mit atraumatischer Zahnung
 with atraumatic serration
 atraumatiques
 con bacos atraumáticos
 с атравматичной зазубренностью



22,0 cm, 8⁵/₈" 21-54-234-22
 25,0 cm, 9³/₄" 21-54-234-25
 28,0 cm, 11" 21-54-234-28



22,0 cm, 8⁵/₈" 21-54-235-22
 25,0 cm, 9³/₄" 21-54-235-25
 28,0 cm, 11" 21-54-235-28



MAYO-ROBSON

21,0 cm, 8¹/₄" 21-52-230-21 21-52-231-21
 23,0 cm, 9" 21-52-230-23 21-52-231-23
 25,0 cm, 9³/₄" 21-52-230-25 21-52-231-25
 28,0 cm, 11" 21-52-230-28 21-52-231-28



MAYO-ROBSON
 25,0 cm, 9³/₄"

mit atraumatischer Zahnung
 with atraumatic serration
 atraumatiques
 con bacos atraumáticos
 с атравматичной зазубренностью



21-54-230-25



21-54-231-25



BRUNNER
 24,0 cm, 9½"
 21-52-240-24

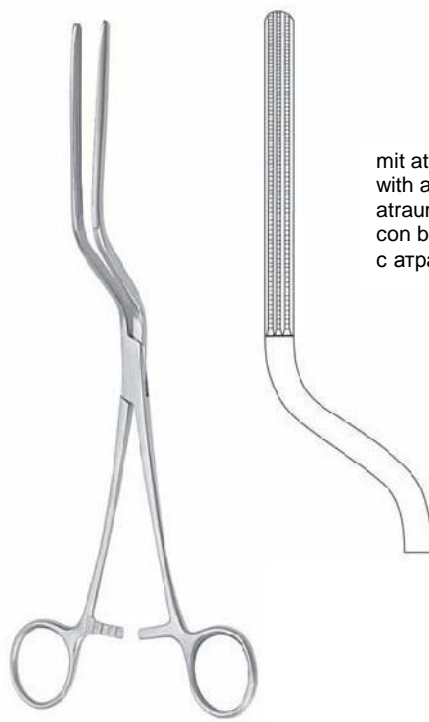

BRUNNER
 24,0 cm, 9½"
 21-54-240-24

mit atraumatischer Zahnung
 with atraumatic serration
 atraumatiques
 con bacos atraumáticos
 с атравматичной зазубренностью



GLASSMAN
 23,0 cm, 9"
 21-52-259-23



GLASSMAN
 23,5 cm, 9¼"
 21-52-253-23

Darm- und Magenquetschklemmen
Intestinal and Stomach Clamps
Pinces -clamps intestinales et d'estomac
Pinzas-clamps intestinales y estomacales
Зажимы кишечные и желудочные



Maullänge length of
 jaws bouche en
 longueur longitud de
 la boca длина
 браншей

5,0 cm, 2" **21-52-320-05**
 7,0 cm, 2½" **21-52-320-07**
 10,0 cm, 4" **21-52-320-10**

DE MARTEL-WOLFSON



DE MARTEL-WOLFSON
 8,5 cm, 3½"
21-52-340-08



DE MARTEL-WOLFSON
 26,0 cm, 10¼"
21-52-325-26



BABY-PAYR
 15,0 cm, 6"



21-52-310-15

mit Stift
 with pin
 avec rayon
 con espiga
 со штифтом



21-52-311-15

ohne Stift
 without pin
 senza perno
 sin espiga
 без штифта



PAYR



21-52-310-21 **21-52-311-21**
29,0 cm, 11½" **21-52-310-29** **21-52-311-29**
35,0 cm, 14" **21-52-310-35** **21-52-311-35**

mit Stift
 with pin
 avec rayon
 con espiga
 со штифтом

ohne Stift
 without pin
 senza perno
 sin espiga
 без штифта



Rektum-Anastomosenklemmen
Sigmoid Anastomosis Forceps
Pinces a Anastomose Rectale
Pinzas para anastomosis de recto
Зажим для сигмовидного анастомоза



MIKULICZ
19,0 cm, 7½"
21-55-010-19

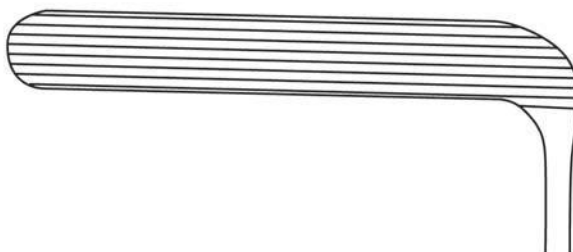

HAYES

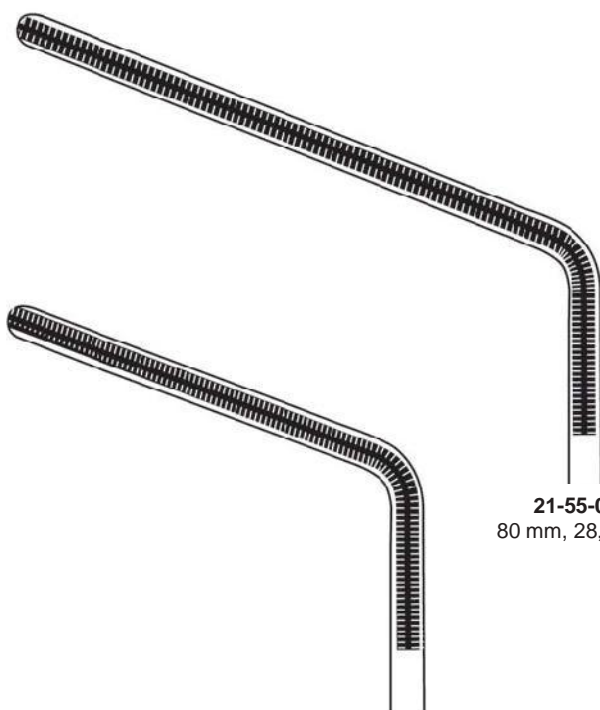

21-55-020-28
80 mm, 28,0 cm 11"

21-55-020-26
55 mm, 26,0 cm 10"



17 x 89 mm

SIMS
15,0 cm, 6"
21-55-108-15



17 x 89 mm

SIMS
15,0 cm, 6"
21-55-110-15



25 x 89 mm

MATHIEU
21,0 cm, 8¼"
21-55-150-21



75 x 23 mm

SMITH-BUIE
15,0 cm, 6"
21-55-160-15

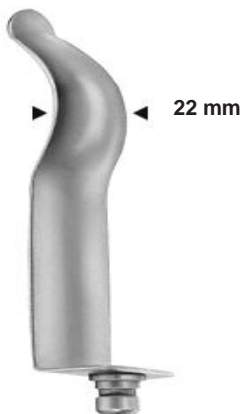

21-55-147-70
Rectum Blätter
rectal blades
paire de valves rectales
pare de valvas rectales
ректальные лопатки
70 mm tief/deep/profondeur/
profondite/глубина

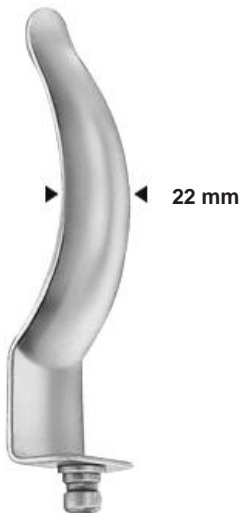

21-55-147-93
Sphincter Blätter
sphincter blades
paire de valves sphincter
pare de valvas esfínter
лопатки сфинктерные
93 mm tief/deep/profondeur/
profondite/глубина



21-55-147-90
Blätter für Anastomosen
Blades for anastomosis
paire de valves anastomoses
pare de valvas anastomosis
лопатки для соустья
90 mm tief/deep/profondeur/
profondite/глубина



21-55-147-15
Blätter für Anastomosen
Blades for anastomosis
paire de valves anastomoses
pare de valvas anastomosis
лопатки для соустья
150 mm tief/deep/profondeur/
profondite/глубина



21-55-147-03
Mittelblatt, center blade,
valve central, центральный шпатель
1 Stück



21-55-147-02

PARKS
13,5 cm, 5 3/8"

PARKS
21-55-147-00

komplett, ohne Kaltlichtanschluß
complete, without cold light connector
complet, sans support lumière froide
completo, sin portador para luz fría
в комплекте, без светодиода

komplett, bestehend aus:
complete, consisting of:
jeu se composant de:
completo, compuesto of:
комплект состоит из:

21-55-147-70
21-55-147-93
1 Paar Blätter/2 pairs of blades/2 pares de valvas/
2 paires de valves/ 1 пара лопаток

21-55-147-02
1 Sperrer allein/only Spreader/Separador suelto/
Ecarteur seul / только рамка

21-55-147-03
1 Mittelblatt /Central blade /valva central/
valve central / центральный шпатель

PARKS
21-55-147-01

komplett, mit Kaltlichtanschluß
complete, with cold light connector
complet, avec support lumière froide
completo, con portador para luz fría
в комплекте, со световодом



\varnothing 16 x 65 mm **21-55-212-01**
 \varnothing 19 x 65 mm **21-55-212-02**
 \varnothing 22 x 65 mm **21-55-212-03**

HIRSCHMANN



\varnothing 22 x 50 mm **21-55-280-01**
 \varnothing 22 x 100 mm **21-55-280-02**
 \varnothing 22 x 140 mm **21-55-280-03**
 \varnothing 22 x 200 mm **21-55-280-04**

KELLY



\varnothing 21 x 50 mm **21-55-285-01**
 \varnothing 27 x 50 mm **21-55-285-02**

KELLY

Mastdarm-Biopsiezangen
 Rectal Biopsy Forceps
 Pincas pour Biopsie Rectale
 Pinzas sacabocado para biopsia rectal
 Биопсийные ректальные щипцы



Ø 22 x 65 mm 21-55-250-22
 Ø 30 x 65 mm 21-55-250-30

CHELSEA EATON



IVES FANSLER
 Ø 22 mm
 21-55-268-01

ohne Kaltlichtträger
 without cold light carrier
 sans support lumière froide
 sin portador para luz fría
 без держателя световодного
 кабеля

IVES FANSLER
 Ø 22 mm
 21-55-268-02

mit Kaltlichtträger
 with cold light carrier
 avec support lumière froide
 con portador para luz fría
 с держателем световодного
 кабеля



Ø 17 x 60 mm 21-55-220-01
 Ø 17 x 80 mm 21-55-220-02
 Ø 20 x 65 mm 21-55-220-03
 Ø 20 x 80 mm 21-55-220-04
 Ø 24 x 65 mm 21-55-220-05
 Ø 24 x 80 mm 21-55-220-06

MORGAN



21-55-220-00
KALTLICHT
COLD LIGHT CARRIER
 support lumière froide
 Aufsatz allein
 Spare fire light Attachment
 Adapteur lumière froide seul
 Cabeza de luz fria suelta
 только насадка



YEOMAN



Fig. 1



28,0 cm, 11" **21-55-300-28**
 35,0 cm, 13¾" **21-55-300-35**
 42,0 cm, 16½" **21-55-300-42**



Fig. 2



28,0 cm, 11" **21-55-311-28**
 35,0 cm, 13¾" **21-55-311-35**
 42,0 cm, 16½" **21-55-311-42**

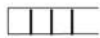
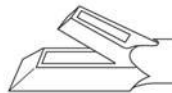

Fig. 3



28,0 cm, 11" **21-55-301-28**
 35,0 cm, 13¾" **21-55-301-35**
 42,0 cm, 16½" **21-55-301-42**



Fig. 4

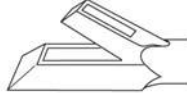

28,0 cm, 11" **21-55-312-28**
 35,0 cm, 13¾" **21-55-312-35**
 42,0 cm, 16½" **21-55-312-42**



RUDD
21-55-400-00

Ø 12,0 mm

Hämorrhoiden-Ligator mit Ladekonus
Haemorrhoidal ligator with loading attachment
Ligateur pour Hémorroïdes avec cône de charge
Ligador para hemorroides con cono de carga
Геморроидальный лигатор с накладкой

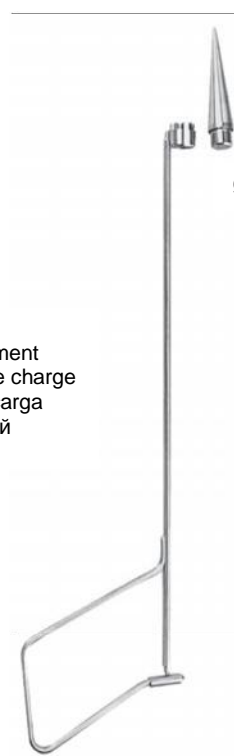

MC GIVNEY
21-55-410-00

Ø 12,0 mm

Hämorrhoiden-Fasszangen, Fistelsonden
Haemorrhoidal Forceps, Fistula probes
Pincers pour Hémorroïdes, Sondas pour fistule
Pinza-clamps para hemorroides, Sondas para fístula
Геморроидальные щипцы, крючок для фистулы



MC GIVNEY
19,0 cm, 7½"
21-55-473-19

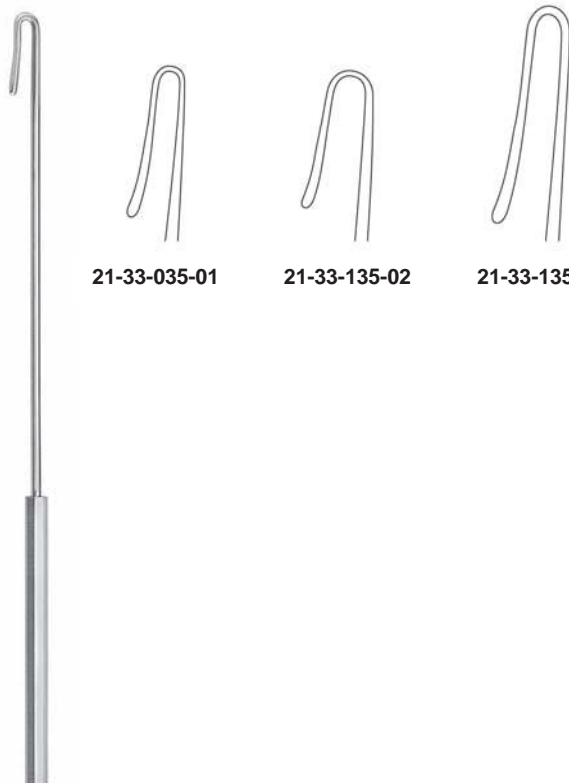

21-33-035-01

21-33-135-02

21-33-135-03

PRATT
21,0 cm, 8¼"

**Gynäkologie, Geburtshilfe
Gynaecology, Obstetrics
Gynécologie, Obstétrique
Ginecología, Obstetricia
Гинекология, акушерство**



für Kinder
 for children
 pour enfants
 para niños
 для детей



COLLIN
 65 x 10 mm
 23-57-134-00

für Jungfrauen
 for virgins
 pour vierge
 para virgenes
 для девственниц



COLLIN
 65 x 20 mm
 23-57-132-00

für Jungfrauen
 for virgins
 pour vierge
 para virgenes
 для девственниц



COLLIN
 85 x 30 mm 23-57-130-01
 100 x 35 mm 23-57-130-02
 110 x 40 mm 23-57-130-03



CUSCO
 75 x 17 mm
 23-57-144-00

zentrale Stellschraube
 central fi xation screw
 vis centrale
 tornillo de sujeto central
 винт центральной фиксации



CUSCO
 75 x 32 mm **23-57-144-01**
 85 x 36 mm **23-57-144-02**
 95 x 37 mm **23-57-144-03**
 100 x 35 mm **23-57-144-04**

seitliche Stellschraube
 lateral fi xation screw
 vis latérale
 tornillo de sujeto lateral
 винт боковой фиксации



für Jungfrauen
 for virgins
 pour vierge
 para virgenes
 для девственниц

CUSCO
 85 x 17 mm
23-57-140-00

seitliche Stellschraube
 lateral fi xation screw
 vis latérale
 tornillo de sujeto lateral
 винт боковой фиксации



CUSCO
 75 x 32 mm **23-57-140-01**
 85 x 35 mm **23-57-140-02**
 100 x 35 mm **23-57-140-03**
 80 x 24 mm **23-57-140-11**

Schweizer Modell
 Swiss pattern
 modèle suisse
 Modelo suizo
 Швейцарская модель



CUSCO
 90 x 23-25 mm **23-57-146-01**
 100 x 25-27 mm **23-57-146-02**
 110 x 27-30 mm **23-57-146-03**



GRAVE
 75 x 20 mm **23-57-100-01**
 95 x 35 mm **23-57-100-02**
 115 x 35 mm **23-57-100-03**



PEDERSON
 175 x 13 mm **23-57-120-01**
 100 x 22 mm **23-57-120-02**
 120 x 25 mm **23-57-120-03**

100 x 16 mm **23-57-120-04** schlank
 slender
 étroit
 estrecho
 узкая модель



SEMM
 100 x 17-20 mm **23-57-150-02**
 100 x 25-30 mm **23-57-150-03**



WEISSBARTH
 21,0 cm, 8¼"
23-57-160-00

komplett mit abnehmbaren Luftfangkorb
 complete with detachable strainer
 complet avec tamis démontable
 completo con tamiz desmontable
 комплект со съёмной коробочкой



mit abnehmbarem Gewicht
 with detachable weight
 poids démontable
 con peso desmontable
 со съёмным весом

AUVARD
 75 x 38 mm **23-57-170-11**
 105 x 40 mm **23-57-170-10**



mit festem Gewicht
 with fixed weight
 poids fixe
 con peso fijo
 с фиксированным весом

AUVARD
 75 x 38 mm **23-57-170-21**
 105 x 40 mm **23-57-170-20**



23-57-180-03
 Griff allein
 handle only
 Manche pour
 Mango suelto
 только ручка

400 g **23-57-180-40**
 800 g **23-57-180-80**

Gewicht allein
 weight only
 Poids pour
 Pesa suelto
 только груз

SCHERBACK
23-57-180-00
 komplett, complete, complet,
 completo, в комплекте



80 x 30 mm
23-57-180-04



85 x 35 mm
23-57-180-05

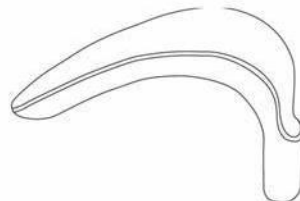

90 x 40 mm
23-57-180-06

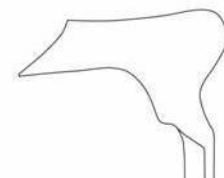

55 x 40-60 mm
23-57-180-07

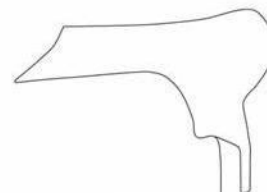

70 x 45-70 mm
23-57-180-08



Satz
 Set
 Jeu
 Juego
 Набор

KRISTELLER
 Fig. 1 23-57-220-01
 Fig. 2 23-57-220-02
 Fig. 3 23-57-220-03



Spekula allein, flach
 Specula only, flat hollow
 Espécules suelto,
 con huecos planos
 Speculums seul, plats
 только зеркало,
 плоско-вогнутое

KRISTELLER
 105 x 26 mm 23-57-221-01
 105 x 28 mm 23-57-221-02
 105 x 33 mm 23-57-221-03



Halter allein
 Retractors only
 valves vaginale seul
 Valvas suelto
 только ретракторы

KRISTELLER
 115 x 22 mm 23-57-222-01
 115 x 24 mm 23-57-222-02
 115 x 29 mm 23-57-222-03



Satz
 Set
 Jeu
 Juego
 Набор

KRISTELLER
 Fig. 1 23-57-230-01
 Fig. 2 23-57-230-02
 Fig. 3 23-57-230-03



Spekula allein, flach
 Specula only, flat hollow
 Espécules suelto,
 con huecos planos
 Speculums seul, plats
 только зеркало,
 плоско-вогнутое

KRISTELLER
 110 x 27 mm 23-57-231-01
 110 x 30 mm 23-57-231-02
 110 x 36 mm 23-57-231-03



Halter allein
 Retractors only
 valves vaginale seul
 Valvas suelto
 только ретракторы

KRISTELLER
 115 x 23 mm 23-57-232-01
 115 x 26 mm 23-57-232-02
 115 x 32 mm 23-57-232-03



Satz
Set
Jeu
Juego
Набор

KRISTELLER
Fig. 0 **23-57-234-00**
Fig. 1 **23-57-234-01**
Fig. 2 **23-57-234-02**
Fig. 3 **23-57-234-03**



Spekula allein
Specula only
Speculums seul
Espécules suelto
только зеркало

KRISTELLER
70 x 15 mm **23-57-235-00**
70 x 27 mm **23-57-235-01**
80 x 30 mm **23-57-235-02**
90 x 36 mm **23-57-235-03**



Halter allein
Retractors only
valves vaginale, seul
Valvas suelto
только ретракторы

KRISTELLER
175 x 10 mm **23-57-236-00**
175 x 23 mm **23-57-236-01**
185 x 26 mm **23-57-236-02**
100 x 32 mm **23-57-236-03**

konisch, für Jungfrauen
conical blades, for virgins
valve coniche, pour vierge
valvos cónicos, para virgenes
конические шпатели, для
девственниц



Satz
Set
Jeu
Juego
Набор

KRISTELLER
Fig. 00 **23-57-237-01**
Fig. 0 **23-57-237-02**



Spekula allein
Specula only
Speculums seul
Espécules suelto
только зеркало

KRISTELLER
105 x 18 mm **23-57-238-01**
105 x 21 mm **23-57-238-02**



Halter allein
Retractors only
valves vaginale seul
Valvas suelto
только ретракторы

KRISTELLER
110 x 14 mm **23-57-239-01**
110 x 17 mm **23-57-239-02**



leicht hohl slightly-
 concave légèrement
 concave légèrement
 concaves незначительно
 вогнутое

Fig. a x b

- 1 60 x 35 mm **23-57-267-01**
- 2 90 x 35 mm **23-57-267-02**
- 3 120 x 35 mm **23-57-267-03**

- 1 60 x 45 mm **23-57-268-01**
- 2 90 x 45 mm **23-57-268-02**
- 3 120 x 45 mm **23-57-268-03**
- 4 160 x 45 mm **23-57-261-04**

- 1 60 x 60 mm **23-57-269-01**
- 2 90 x 60 mm **23-57-269-02**
- 3 120 x 60 mm **23-57-269-03**
- 4 160 x 60 mm **23-57-262-04**

DOYEN
 23,0 cm, 9"



leicht hohl slightly-
 concave légèrement
 concave légèrement
 concaves незначительно
 вогнутое

Fig. a x b

- 1 55 x 35 mm **23-57-260-01**
- 2 85 x 35 mm **23-57-260-02**
- 3 115 x 35 mm **23-57-260-03**

- 1 55 x 45 mm **23-57-261-01**
- 2 85 x 45 mm **23-57-261-02**
- 3 115 x 45 mm **23-57-261-03**

- 1 55 x 60 mm **23-57-262-01**
- 2 85 x 60 mm **23-57-262-02**
- 3 115 x 60 mm **23-57-262-03**

DOYEN
 23,0 cm, 9"



halb-hohl
slightly-concave
demi concave
semi-concavos
средне-вогнутое

Fig. a x b

- | | | |
|---|--------------------|---------------------|
| 1 | <u>60 x 35 mm</u> | 23-57-264-01 |
| 2 | <u>90 x 35 mm</u> | 23-57-264-02 |
| 3 | <u>120 x 35 mm</u> | 23-57-264-03 |
| 4 | <u>130 x 35 mm</u> | 23-57-264-04 |

- | | | |
|---|--------------------|---------------------|
| 1 | <u>60 x 45 mm</u> | 23-57-265-01 |
| 2 | <u>90 x 45 mm</u> | 23-57-265-02 |
| 3 | <u>120 x 45 mm</u> | 23-57-265-03 |
| 4 | <u>130 x 45 mm</u> | 23-57-265-04 |

- | | | |
|---|--------------------|---------------------|
| 1 | <u>60 x 60 mm</u> | 23-57-266-01 |
| 2 | <u>90 x 60 mm</u> | 23-57-266-02 |
| 3 | <u>120 x 60 mm</u> | 23-57-266-03 |
| 4 | <u>130 x 60 mm</u> | 23-57-266-04 |

DOYEN
23,0 cm, 9°

a x b

70 x 25 mm **23-57-302-25**

100 x 20 mm **23-57-307-20**
100 x 25 mm **23-57-307-25**
100 x 30 mm **23-57-307-30**
100 x 35 mm **23-57-307-35**
100 x 40 mm **23-57-307-40**

120 x 20 mm **23-57-317-20**
120 x 25 mm **23-57-317-25**
120 x 30 mm **23-57-317-30**
120 x 35 mm **23-57-317-35**
120 x 40 mm **23-57-317-40**

130 x 20 mm **23-57-308-20**
130 x 25 mm **23-57-308-25**
130 x 30 mm **23-57-308-30**
130 x 35 mm **23-57-308-35**
130 x 40 mm **23-57-308-40**

155 x 40 mm **23-57-309-40**

160 x 20 mm **23-57-303-20**
160 x 25 mm **23-57-303-25**
160 x 30 mm **23-57-303-30**
160 x 35 mm **23-57-303-35**
160 x 40 mm **23-57-303-40**

180 x 20 mm **23-57-304-20**
180 x 25 mm **23-57-304-25**
180 x 30 mm **23-57-304-30**
180 x 35 mm **23-57-304-35**
180 x 40 mm **23-57-304-40**



BREISKY



Satz
 Set
 Jeu
 Juego
 Набор

KALLMORGEN
 70 x 40 mm **23-57-270-01**
 90 x 40 mm **23-57-270-02**



Spekula allein
 Specula only
 Speculums seul
 Espécules suelto
 только зеркало

KALLMORGEN
 70 x 40 mm **23-57-271-01**
 90 x 40 mm **23-57-271-02**



Halter allein
 Retractors only
 Valves vaginale seul
 Valvas suelto
 только ретрактор

KALLMORGEN
 70 x 33 mm **23-57-272-01**
 90 x 33 mm **23-57-272-02**



70 x 15 mm

KRISTELLER
 17,0 cm, 6³/₄"
23-57-275-17



JACKSON
 175 x 38 mm **23-57-290-01**
 190 x 38 mm **23-57-290-02**
 100 x 38 mm **23-57-290-03**



BREISKY
14,0 cm, 5½"
23-57-292-01



BREISKY
14,0 cm, 5½"
23-57-292-02



BREISKY
17,0 cm, 6¾"
23-57-292-03



BREISKY
17,0 cm, 6¾"
23-57-292-04

SIMS
 23-57-294-00
 Satz, Set, Jeu,
 Juego, набор



SIMS
 12,5 cm, 5"
 23-57-294-01

SIMS
 15,0 cm, 6"
 23-57-294-02

SIMS
 17,5 cm, 7"
 23-57-294-03



MATHIEU
 100 x 13-23 mm 23-57-300-01
 100 x 16-30 mm 23-57-300-02



MATHIEU
 100 x 11-21 mm 23-57-301-01
 100 x 14-27 mm 23-57-301-02



LANDAU
 100 x 28 mm 23-57-305-01
 100 x 30 mm 23-57-305-02



85 x 17 mm

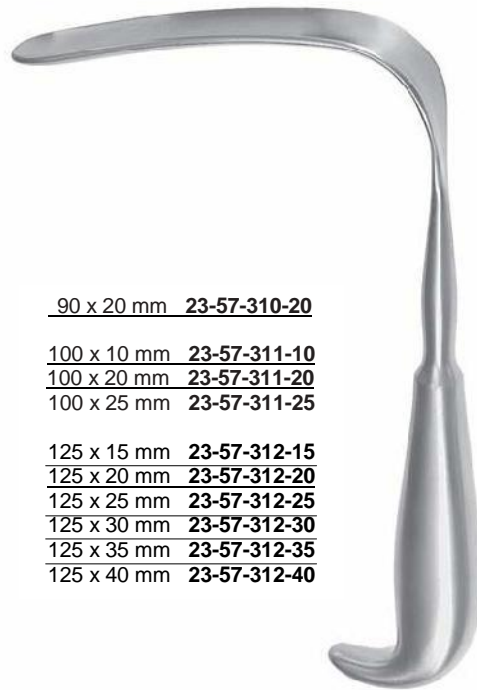

90 x 20 mm 23-57-310-20

100 x 10 mm 23-57-311-10

100 x 20 mm 23-57-311-20

100 x 25 mm 23-57-311-25

125 x 15 mm 23-57-312-15

125 x 20 mm 23-57-312-20

125 x 25 mm 23-57-312-25

125 x 30 mm 23-57-312-30

125 x 35 mm 23-57-312-35

125 x 40 mm 23-57-312-40

BRAUN, MODIF.
 19,0 cm, 7½"
 23-57-313-19

MATZENAUER



60 x 30 mm



70 x 38 mm



80 x 30 mm



95 x 38 mm

DOYEN
 23,0 cm, 9"
 23-57-315-23

DOYEN
 24,0 cm, 9½"
 23-57-315-24

DOYEN
 25,0 cm, 10"
 23-57-315-25

WERTHEIM
 30,0 cm, 12"
 23-57-317-30

Lateral-Spekulum, Intrauterinsonde Lateral
 Speculum, Intrauterine Probe Latéral
 Speculum, Intra-utérine bougie Espécule
 lateral, Sonda intra-uterina Боковые
 зеркала, внутриматочный зонд

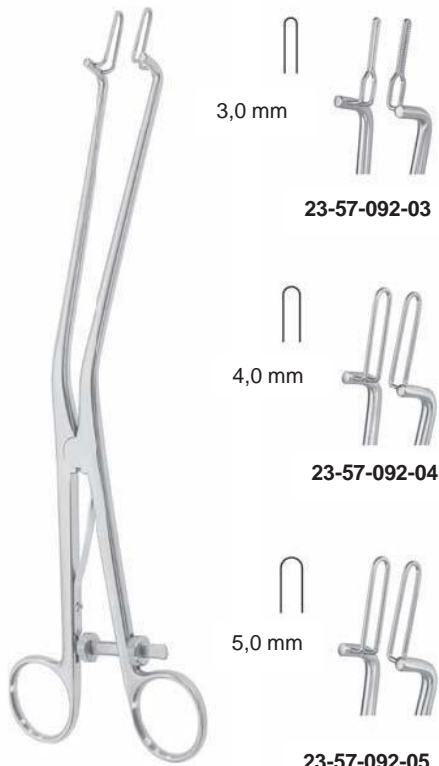

**KOGAN
 Standard**
 24,0 cm, 9½"

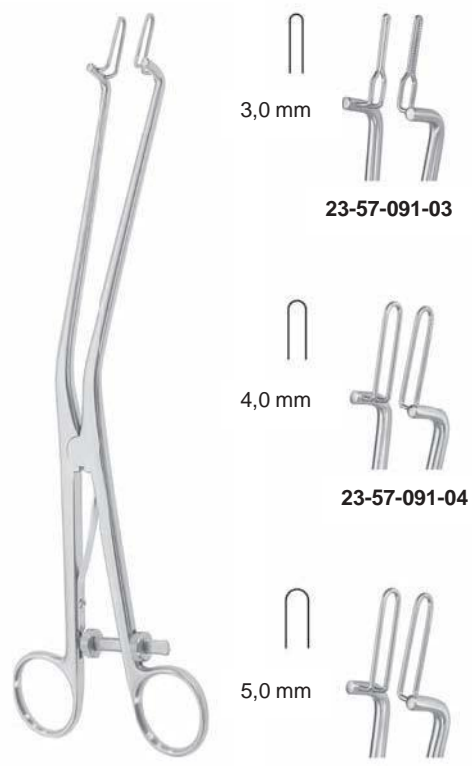

**KOGAN
 Laser**
 24,0 cm, 9½"

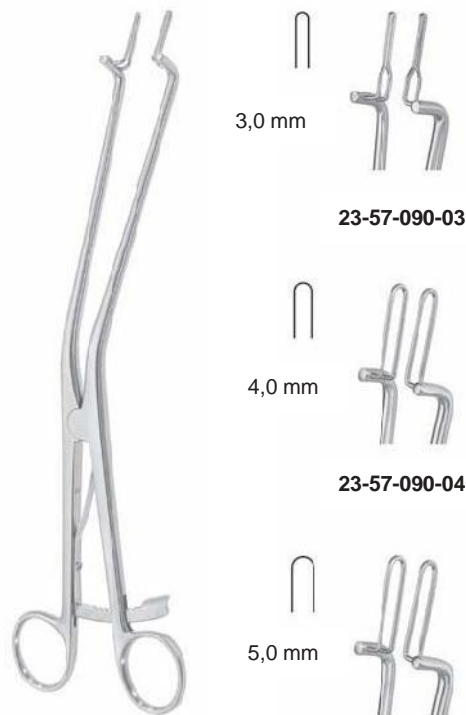

KOGAN
 24,0 cm, 9½"



Lateral-Spekulum
Lateral speculum
Latéral Speculum
Espécula lateral
боковое зеркало

25,0 cm, 10"
23-57-096-25



COHEN
23-57-530-00

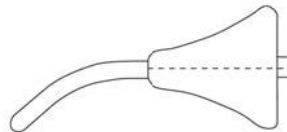

COHEN
23-57-530-01

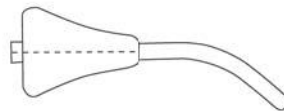

COHEN
23-57-530-02

Uterus-Dilatatoren
 Uterine Dilators
 Dilatateurs du col de l'utérus
 Dilatadores uterinos
 Расширители шейки матки

- Ø 1.0 mm 23-57-350-01
- Ø 2.0 mm 23-57-350-02
- Ø 3.0 mm 23-57-350-03
- Ø 4.0 mm 23-57-350-04
- Ø 5.0 mm 23-57-350-05
- Ø 6.0 mm 23-57-350-06
- Ø 7.0 mm 23-57-350-07
- Ø 8.0 mm 23-57-350-08
- Ø 9.0 mm 23-57-350-09
- Ø 10.0 mm 23-57-350-10
- Ø 11.0 mm 23-57-350-11
- Ø 12.0 mm 23-57-350-12
- Ø 13.0 mm 23-57-350-13
- Ø 14.0 mm 23-57-350-14
- Ø 15.0 mm 23-57-350-15
- Ø 16.0 mm 23-57-350-16
- Ø 17.0 mm 23-57-350-17
- Ø 18.0 mm 23-57-350-18
- Ø 19.0 mm 23-57-350-19
- Ø 20.0 mm 23-57-350-20
- Ø 21.0 mm 23-57-350-21
- Ø 22.0 mm 23-57-350-22
- Ø 23.0 mm 23-57-350-23
- Ø 24.0 mm 23-57-350-24
- Ø 25.0 mm 23-57-350-25
- Ø 26.0 mm 23-57-350-26
- Ø 27.0 mm 23-57-350-27
- Ø 28.0 mm 23-57-350-28
- Ø 29.0 mm 23-57-350-29
- Ø 30.0 mm 23-57-350-30
- Ø 32.0 mm 23-57-350-32



HEGAR
 18,5 cm, 7¼"



HEGAR
 18,5 cm, 7¼"

- Ø 1.5 mm 23-57-351-01
- Ø 2.5 mm 23-57-351-02
- Ø 3.5 mm 23-57-351-03
- Ø 4.5 mm 23-57-351-04
- Ø 5.5 mm 23-57-351-05
- Ø 6.5 mm 23-57-351-06
- Ø 7.5 mm 23-57-351-07
- Ø 8.5 mm 23-57-351-08
- Ø 9.5 mm 23-57-351-09
- Ø 10.5 mm 23-57-351-10
- Ø 11.5 mm 23-57-351-11
- Ø 12.5 mm 23-57-351-12
- Ø 13.5 mm 23-57-351-13
- Ø 14.5 mm 23-57-351-14
- Ø 15.5 mm 23-57-351-15
- Ø 16.5 mm 23-57-351-16
- Ø 17.5 mm 23-57-351-17
- Ø 18.5 mm 23-57-351-18
- Ø 19.5 mm 23-57-351-19
- Ø 20.5 mm 23-57-351-20
- Ø 21.5 mm 23-57-351-21
- Ø 22.5 mm 23-57-351-22
- Ø 23.5 mm 23-57-351-23

205 x 105 x 45 mm



HEGAR
23-57-350-98
 Satz, Set, Jeu, Juego, набор
 Ø 4,0 - Ø 17,0
 (14 dilators)

HEGAR
23-57-350-99
 Satz, Set, Jeu, Juego, набор
 Ø 1,0 - Ø 26,0
 (26 dilators)



20,0 cm, 8"

| | |
|------------------|---------------------|
| Ø 1,0 / 2,0 mm | 23-57-354-01 |
| Ø 3,0 / 4,0 mm | 23-57-354-03 |
| Ø 5,0 / 6,0 mm | 23-57-354-05 |
| Ø 7,0 / 8,0 mm | 23-57-354-07 |
| Ø 9,0 / 10,0 mm | 23-57-354-09 |
| Ø 11,0 / 12,0 mm | 23-57-354-11 |
| Ø 13,0 / 14,0 mm | 23-57-354-13 |
| Ø 15,0 / 16,0 mm | 23-57-354-15 |
| Ø 17,0 / 18,0 mm | 23-57-354-17 |
| Ø 19,0 / 20,0 mm | 23-57-354-19 |
| Ø 21,0 / 22,0 mm | 23-57-354-21 |
| Ø 23,0 / 24,0 mm | 23-57-354-23 |
| Ø 25,0 / 26,0 mm | 23-57-354-25 |

HEGAR

Satz, Set, Jeu, Juego, набор

23-57-354-98 Ø 3,0 / 4,0 - Ø 17,0 / 18,0 mm (8 dilators)

23-57-354-99 Ø 1,0 / 2,0 - Ø 25,0 / 26,0 mm (13 dilators)

Metalletui, Metal case, en boîte métal,

Estuche de metal, коробка металлическая



HEGAR

23-57-354-97

Satz, Set, Jeu, Juego, набор

3,0 / 4,0 - 17/18 mm (8 dilators)

Tasche / bag / poche / el bolso / сумка



| | |
|-----------------|---------------------|
| Ø 4,5 / 5,0 mm | 23-57-360-05 |
| Ø 5,5 / 6,0 mm | 23-57-360-06 |
| Ø 6,5 / 7,0 mm | 23-57-360-07 |
| Ø 7,5 / 8,0 mm | 23-57-360-08 |
| Ø 8,5 / 9,0 mm | 23-57-360-09 |
| Ø 9,5 / 10,0 mm | 23-57-360-10 |

HANK

23-57-360-98

Satz, Set, Jeu, Juego, набор

Ø 4,5 / 5,0 - Ø 9,5 / 10,0 mm (6 dilators)

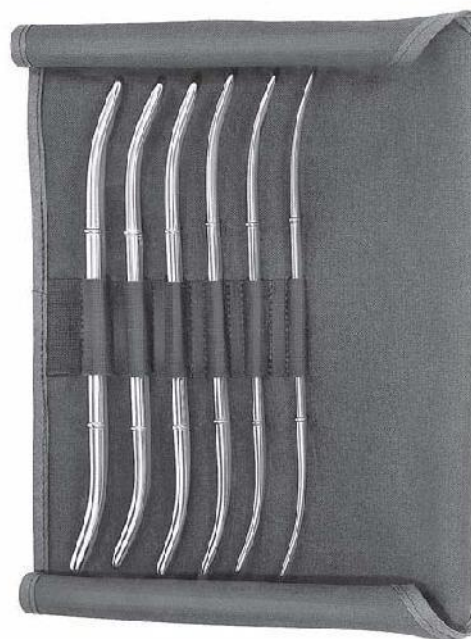

HANK

23-57-360-99

Satz, Set, Jeu, Juego, набор

Ø 4,5 / 5,0 - Ø 9,5 / 10,0 mm (6 dilators)

Tasche / bag / poche / el bolso / сумка

Hakenzangen Uterine
Tenaculum Forceps
Pince pour le col de l'utérus
Pinzas para coger el cuello del útero
Щипцы зубчатые маточные



PRATT
26,5 cm, 10 3/8"

| | |
|------------------|---------------------|
| Ø 4,5 / 5,0 mm | 23-57-370-05 |
| Ø 5,5 / 6,0 mm | 23-57-370-06 |
| Ø 7,5 / 8,0 mm | 23-57-370-08 |
| Ø 8,5 / 9,0 mm | 23-57-370-09 |
| Ø 9,5 / 10,0 mm | 23-57-370-10 |
| Ø 11,5 / 12,0 mm | 23-57-370-12 |
| Ø 12,5 / 13,0 mm | 23-57-370-13 |
| Ø 13,5 / 14,0 mm | 23-57-370-14 |



PRATT
23-57-370-98
Satz, Set, Jeu, Juego, набор
Ø 4,5 / 5,0 - Ø 13,5 / 14,0 mm (8 dilators)



BARRETT
18,0 cm, 7"
23-57-410-18



ADAIR
19,0 cm, 7 1/2"
23-57-412-19



STAUDE-MOORE
17,0 cm, 6 3/4"
23-57-414-17

Uterus-Dilatatoren, Hakenzange
Uterine Dilators, Uterine Tenaculum Forceps
Dilatateurs du col de l'utérus, Pince pour le col de l'utéro
Dilatadores uterinos, Pinzas para coger el cuello del útero
Расширители шейки матки, щипцы зубчатые маточны

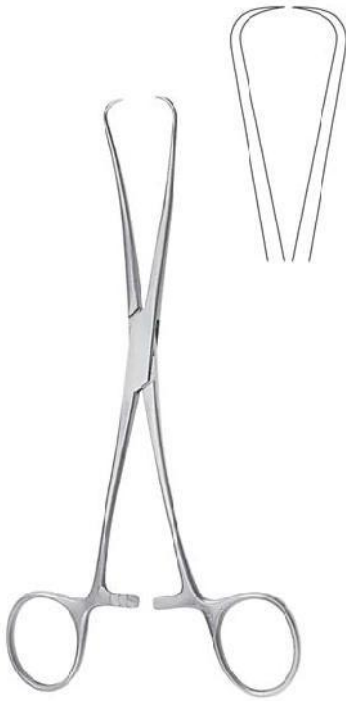

JARCHO
 20,0 cm, 8"
 23-57-417-20



SCHROEDER
 25,0 cm, 9 3/4"
 23-57-400-25



BRAUN
 25,0 cm, 9 3/4"
 23-57-404-25



DUPLAY
 28,0 cm, 11"
 23-57-419-28



POZZI
 17,0 cm, 6 3/4" 23-57-402-17
 25,0 cm, 10" 23-57-402-25



KAHN
 22,0 cm, 8 3/4"
 23-57-421-22

Hakenzangen
Uterine Tenaculum Forceps
Pince pour le col de l'utérus
Pinzas para coger el cuello del útero
Щипцы зубчатые маточные



SKENE
 24,0 cm, 9½"
 23-57-423-24



SCHROEDER
 20,0 cm, 8" 23-57-426-20
 24,0 cm, 9½" 23-57-426-24



SCHROEDER

gebogen, curved, arqué,
 curva, изогнутые

20,0 cm, 8" 23-57-429-20
 24,0 cm, 9½" 23-57-429-24

seitlich gebogen
 curved to side
 latéral arqué
 en ellado porcido
 на сторону изогнутые

24,0 cm, 9½" 23-57-430-24



TEALE
 23,0 cm, 9"
 23-57-431-23



JACOBS
 21,0 cm, 8½"
 23-57-434-21



JACOBS
 21,0 cm, 8½"
 23-57-435-21





MUSEUX
 24,0 cm, 9½"



MUSEUX
 24,0 cm, 9½"



BRAUN
 15,5 cm, 6"
 23-57-442-15



CZERNY
 20,5 cm, 8"
 23-57-444-20



PRATT
 28,0 cm, 11"
 23-57-446-28



IOWA
 26,0 cm, 10¼"
 23-57-449-26



DOYEN
 20,5 cm, 8"
 23-57-470-20

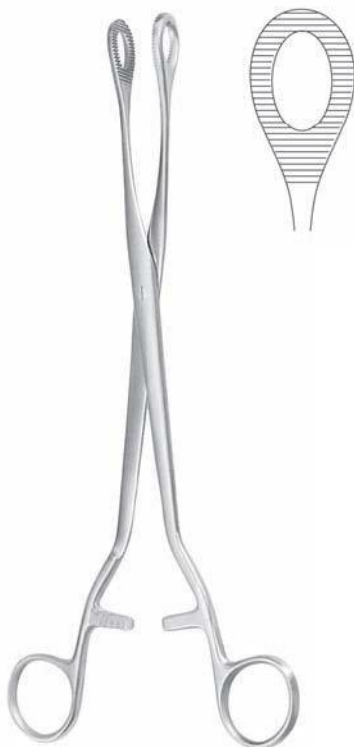

NOTO
 27,0 cm, 10⁵/₆"
 23-57-472-27

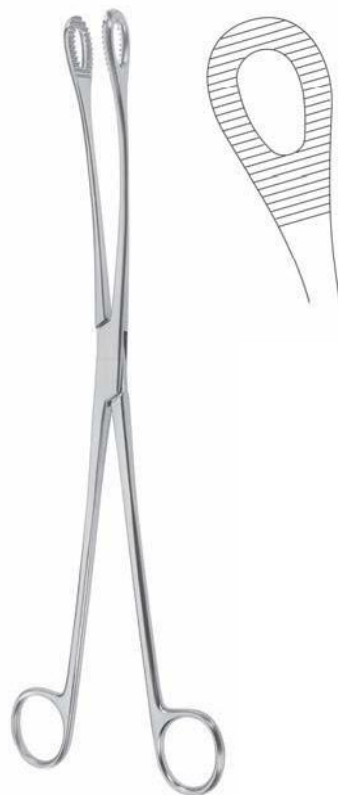

KELLY
 32,0 cm, 12¹/₂"
 23-57-475-32



HEYWOOD-SMITH
 21,0 cm, 8³/₄" 23-57-480-21
 25,0 cm, 9³/₄" 23-57-480-25



DARTIGUES
 27,0 cm, 10³/₄"
 23-57-482-27



SOMER
 23,0 cm, 9"
 23-57-485-23



0°
straight
droit
recta
прямые

23-57-488-25

COLLIN
25,0 cm, 9¾"



45° gerade
gewinkelt
angled
angulaire
coudes
под углом

23-57-489-25

BEACHAM
26,0 cm, 10¼"
23-57-500-26

Amniotom
Amniotome
Amniotome
Amniótomo
АМНИОТОМ



Uterus-Depressor
Uterine depressor
Dépresseur utérin
Depresor uterino
АМНИОТОМ

BRAUN
28,0 cm, 11"
23-57-502-28



Uterus-Depressor
Uterine depressor
Dépresseur utérin
Depresor uterino
АМНИОТОМ

SIMS
26,0 cm, 10¼"
23-57-505-26



biegsam
malleable
malléable
maleable
изгибаемый

SIMS
32,0 cm, 12½"
23-57-510-32



SIMS
32,0 cm, 12½"
23-57-511-32



MARTÍN
32,0 cm, 12½"
23-57-516-32



MARTÍN
32,0 cm, 12½"
23-57-518-32

biegsam
malleable
malléable
maleable
изгибаемый



SIMPSON
29,0 cm, 11½" Ø 4 mm
23-57-527-29

biegsam
malleable
malléable
maleable
изгибаемый



VALLEIX
25,0 cm, 10"
23-57-521-25



COLLIN
28,0 cm, 11" Ø 4 mm
23-57-529-28



KEVORKIAN
 30,0 cm, 12"
 23-57-540-30



KEVORKIAN
 30,0 cm, 12"
 23-57-542-30



1,2 mm **23-57-543-12**
 4,0 mm **23-57-544-40**

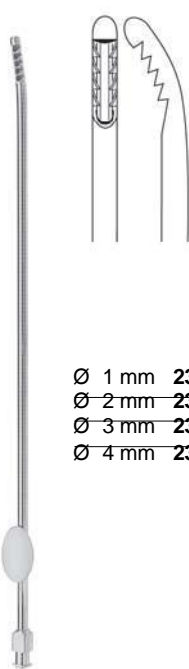

NOVAK
 23,0 cm, 9" Ø 4 mm



RANDALL
 23,0 cm, 9" Ø 4 mm
 23-57-552-04



MILAN
 28,0 cm, 11"



Ø 4 mm
23-57-560-04



Ø 6 mm
23-57-560-06



Ø 9 mm
23-57-560-09



25,0 cm, 9 $\frac{3}{4}$ "
 23-57-570-25



17,0 cm, 6 $\frac{3}{4}$ "
 23-57-572-17



SIMON
 22,0 cm, 8 $\frac{5}{8}$ "
 23-57-574-22



EMMETT
 22,0 cm, 8 $\frac{5}{8}$ "



23-57-576-01



23-57-576-02



23-57-576-03



23-57-576-04



23-57-576-05



SEGOND
 27,0 cm, 10 $\frac{5}{8}$ "
 23-57-580-27



AYRE
 23,0 cm, 9"
 23-57-583-23

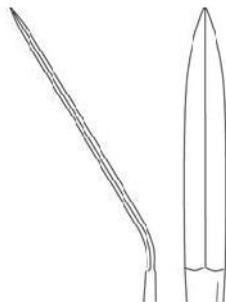

DOYEN
 17,0 cm, 6 $\frac{3}{4}$ "
 23-57-588-01



DOYEN
 17,0 cm, 6 $\frac{3}{4}$ "
 23-57-588-02

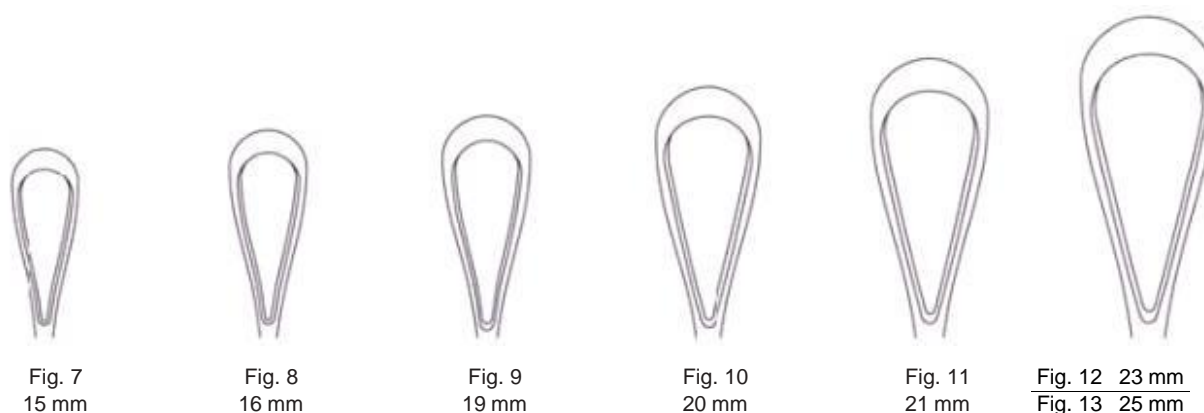
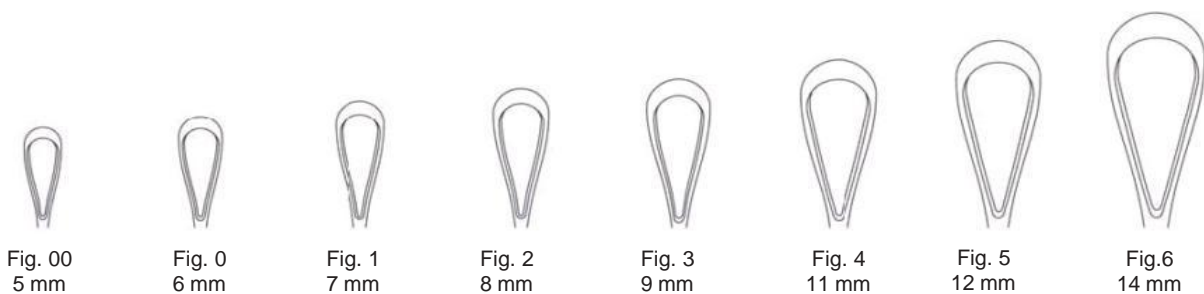

stumpf, starr
blunt, rigid
mousse, rigide
romo, rígidas
тупые, жёсткие

- Fig. 00 23-57-700-05
- Fig. 0 23-57-700-06
- Fig. 1 23-57-700-07
- Fig. 2 23-57-700-08
- Fig. 3 23-57-700-09
- Fig. 4 23-57-700-11
- Fig. 5 23-57-700-12
- Fig. 6 23-57-700-14
- Fig. 7 23-57-700-15
- Fig. 8 23-57-700-16
- Fig. 9 23-57-700-19
- Fig. 10 23-57-700-20
- Fig. 11 23-57-700-21
- Fig. 12 23-57-700-23
- Fig. 13 23-57-700-25

RECAMIER
31,0 cm, 12¼"



stumpf, biegsam
blunt, malleable
mousse, malléable
romo, maleable
тупые, изгибаемые

- Fig. 00 23-57-701-05
- Fig. 0 23-57-701-06
- Fig. 1 23-57-701-07
- Fig. 2 23-57-701-08
- Fig. 3 23-57-701-09
- Fig. 4 23-57-701-11
- Fig. 5 23-57-701-12
- Fig. 6 23-57-701-14
- Fig. 7 23-57-701-15
- Fig. 8 23-57-701-16
- Fig. 9 23-57-701-19
- Fig. 10 23-57-701-20
- Fig. 11 23-57-701-21
- Fig. 12 23-57-701-23
- Fig. 13 23-57-701-25

RECAMIER
31,0 cm, 12¼"



Fig. 00
5 mm

Fig. 0
6 mm

Fig. 1
7 mm

Fig. 2
8 mm

Fig. 3
9 mm

Fig. 4
11 mm

Fig. 5
12 mm

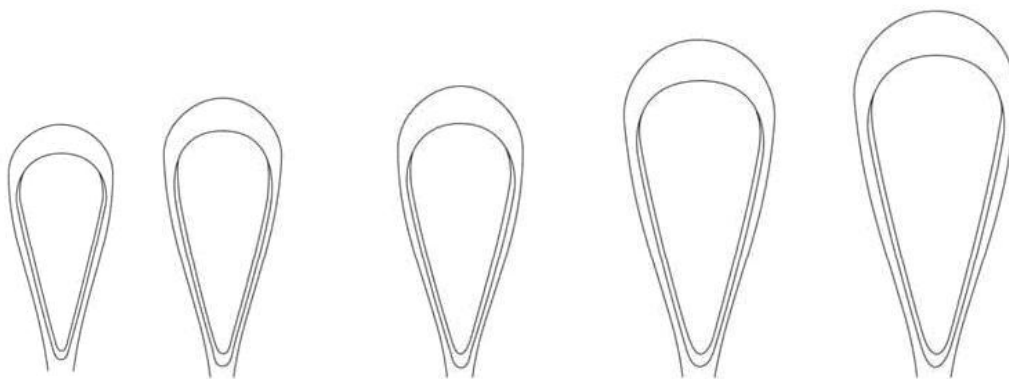

Fig. 6
14 mm

Fig. 7
15 mm

Fig. 8
16 mm

Fig. 9
19 mm

Fig. 10
20 mm



stumpf, starr
 blunt, rigid
 mousse, rigide
 romo, rígidas
 тупые, жёсткие

- Fig. 00 **23-57-702-05**
- Fig. 0 **23-57-702-06**
- Fig. 1 **23-57-702-07**
- Fig. 2 **23-57-702-08**
- Fig. 3 **23-57-702-09**
- Fig. 4 **23-57-702-11**
- Fig. 5 **23-57-702-12**
- Fig. 6 **23-57-702-14**
- Fig. 7 **23-57-702-15**
- Fig. 8 **23-57-702-16**
- Fig. 9 **23-57-702-19**
- Fig. 10 **23-57-702-20**

SIMS
28,0 cm, 11"



stumpf, biegsam
 blunt, malleable
 mousse, malléable
 romo, maleable
 тупые, изгибаемые

- Fig. 00 **23-57-703-05**
- Fig. 0 **23-57-703-06**
- Fig. 1 **23-57-703-07**
- Fig. 2 **23-57-703-08**
- Fig. 3 **23-57-703-09**
- Fig. 4 **23-57-703-11**
- Fig. 5 **23-57-703-12**
- Fig. 6 **23-57-703-14**
- Fig. 7 **23-57-703-15**
- Fig. 8 **23-57-703-16**
- Fig. 9 **23-57-703-19**
- Fig. 10 **23-57-703-20**

SIMS
28,0 cm, 11"



Fig. 00
5 mm

Fig. 0
6 mm

Fig. 1
7 mm

Fig. 2
8 mm

Fig. 3
9 mm

Fig. 4
11 mm

Fig. 5
12 mm

Fig. 6
14 mm

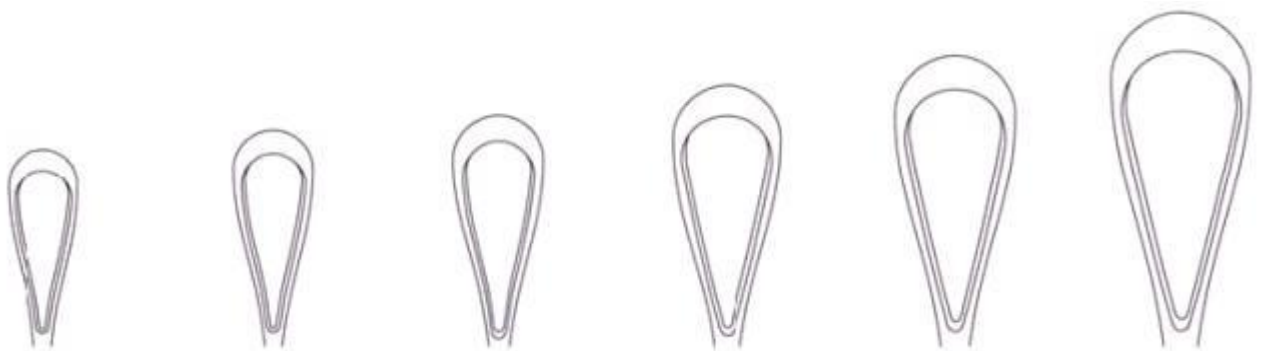

Fig. 7
15 mm

Fig. 8
16 mm

Fig. 9
19 mm

Fig. 10
20 mm

Fig. 11
21 mm

Fig. 12 23 mm
Fig. 13 25 mm



scharf, fest sharp,
 rigid tranchante,
 rigide cortantes,
 rígidas острые,
 жёсткие

- Fig. 00 23-57-0710-05
- Fig. 0 23-57-0710-06
- Fig. 1 23-57-0710-07
- Fig. 2 23-57-0710-08
- Fig. 3 23-57-0710-09
- Fig. 4 23-57-0710-11
- Fig. 5 23-57-0710-12
- Fig. 6 23-57-0710-14
- Fig. 7 23-57-0710-15
- Fig. 8 23-57-0710-16
- Fig. 9 23-57-0710-19
- Fig. 10 23-57-0710-20
- Fig. 11 23-57-0710-21
- Fig. 12 23-57-0710-23
- Fig. 13 23-57-0710-25

RECAMIER
 31,0 cm, 12¼"



scharf, biegsam
 sharp, malleable
 tranchante, malléable
 cortantes, maleable
 острые, изгибаемые

- Fig. 00 23-57-711-05
- Fig. 0 23-57-711-06
- Fig. 1 23-57-711-07
- Fig. 2 23-57-711-08
- Fig. 3 23-57-711-09
- Fig. 4 23-57-711-11
- Fig. 5 23-57-711-12
- Fig. 6 23-57-711-14
- Fig. 7 23-57-711-15
- Fig. 8 23-57-711-16
- Fig. 9 23-57-711-19
- Fig. 10 23-57-711-20
- Fig. 11 23-57-711-21
- Fig. 12 23-57-711-23
- Fig. 13 23-57-711-25

RECAMIER
 31,0 cm, 12¼"



scharf, fest sharp,
 rigid tranchante,
 rigide cortantes,
 rígidas острые,
 жёсткие

- Fig. 00 **23-57-712-05**
- Fig. 0 **23-57-712-06**
- Fig. 1 **23-57-712-07**
- Fig. 2 **23-57-712-08**
- Fig. 3 **23-57-712-09**
- Fig. 4 **23-57-712-11**
- Fig. 5 **23-57-712-12**
- Fig. 6 **23-57-712-14**

SIMS
 28,0 cm, 11"



scharf, biegsam
 sharp, malleable
 tranchante, malléable
 cortantes, maleable
 острые, изгибаемые

- Fig. 00 **23-57-713-05**
- Fig. 0 **23-57-713-06**
- Fig. 1 **23-57-713-07**
- Fig. 2 **23-57-713-08**
- Fig. 3 **23-57-713-09**
- Fig. 4 **23-57-713-11**
- Fig. 5 **23-57-713-12**
- Fig. 6 **23-57-713-14**

SIMS
 28,0 cm, 11"

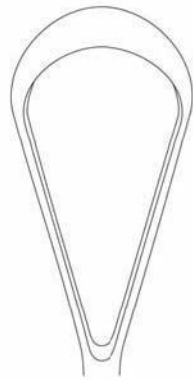

Fig. 1
30 mm



Fig. 2
35 mm

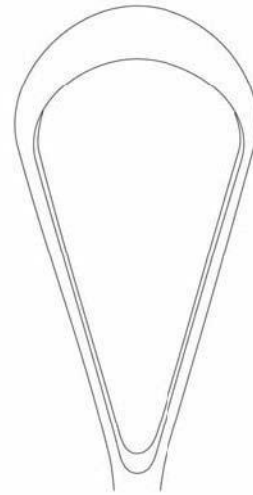

Fig.3
40 mm



scharf, fest sharp,
 rigid tranchante,
 rigide cortantes,
 rígidas острые,
 жёсткие

Fig. 1 **23-57-720-30**
 Fig. 2 **23-57-720-35**
 Fig. 3 **23-57-720-40**

BUMM



scharf, biegsam
 sharp, malleable
 tranchante, malléable
 cortantes, maleable
 острые, изгибаемые

Fig. 1 **23-57-721-30**
 Fig. 2 **23-57-721-35**
 Fig. 3 **23-57-721-40**

BUMM



Fig. 1
30 mm

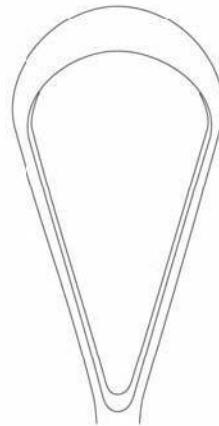

Fig. 2
35 mm

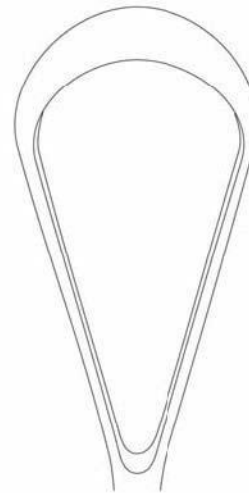

Fig.3
40 mm



BUMM

stumpf, fest
 blunt, rigid
 mousse, rigide
 cortantes, rígidas
 тупые, жёсткие

Fig. 1 23-57-722-30
 Fig. 2 23-57-722-35
 Fig. 3 23-57-722-40



BUMM

stumpf, biegsam
 blunt, malleable
 mousse, malléable
 cortantes, maleable
 тупые, изгибаемые

Fig. 1 23-57-723-30
 Fig. 2 23-57-723-35
 Fig. 3 23-57-723-40



BLAKE
27,0 cm, 10⁵/₈"
23-57-750-27



SIMON
25,0 cm, 9³/₄"

Fig. 1
23-57-760-01

Fig. 2
23-57-760-02

Fig. 3
23-57-760-03

Fig. 4
23-57-760-04

Fig. 5
23-57-760-05

Fig. 6
23-57-760-06



22,0 cm, 8⁵/₈" 23-57-680-22
24,0 cm, 9¹/₂" 23-57-680-24

THOMS-GAYLOR



5 mm

SCHUMACHER-VAN DOREN
24,0 cm, 9¹/₂"
23-57-684-24



4,5 x 8 mm

FAURE
21,0 cm, 8¹/₄"
23-57-688-21

Uteruslöffel, Uterus-Biopsiezangen Uterine Scoopes,
 Cervical Biopsy and Specimen Forceps
 Curettes utérines, Pincas pour biopsie
 Cucharillas uterinas, Pinzas saca-bocados para biopsia
 Ложки маточные, зажимы для взятия биопсии



8 x 5 mm

21,0 cm, 8¹/₄" **23-57-682-21**
 28,0 cm, 11¹/₂" **23-57-682-28**

SCHUBERT



4,5 x 8 mm

SCHUBERT
 26,0 cm, 10¹/₄"
23-57-690-26

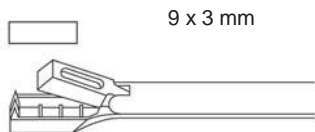
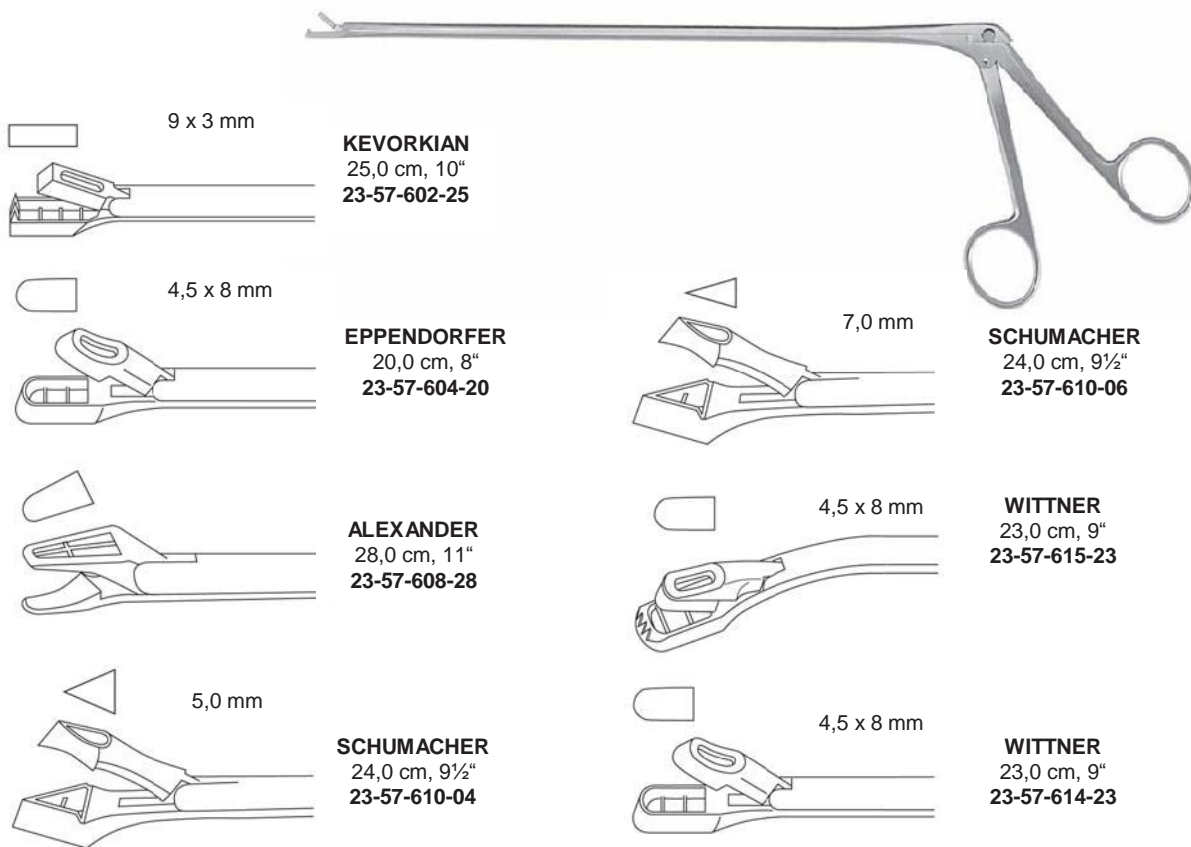

9 x 3 mm

KEVORKIAN
 25,0 cm, 10"
23-57-602-25

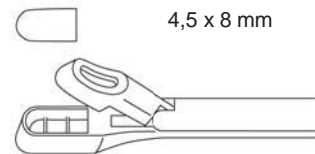

4,5 x 8 mm

EPENDORFER
 20,0 cm, 8"
23-57-604-20

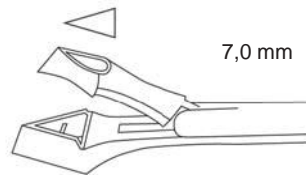

7,0 mm

SCHUMACHER
 24,0 cm, 9¹/₂"
23-57-610-06

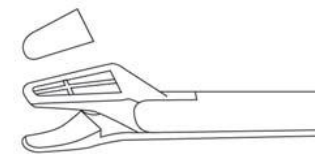

4,5 x 8 mm

ALEXANDER
 28,0 cm, 11"
23-57-608-28

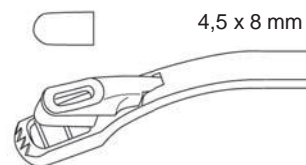

4,5 x 8 mm

WITNER
 23,0 cm, 9"
23-57-615-23

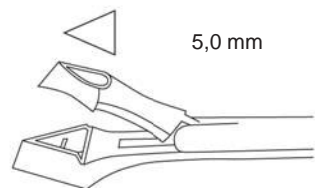

5,0 mm

SCHUMACHER
 24,0 cm, 9¹/₂"
23-57-610-04

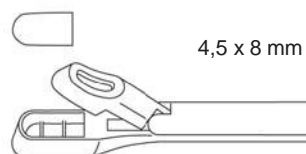

4,5 x 8 mm

WITNER
 23,0 cm, 9"
23-57-614-23

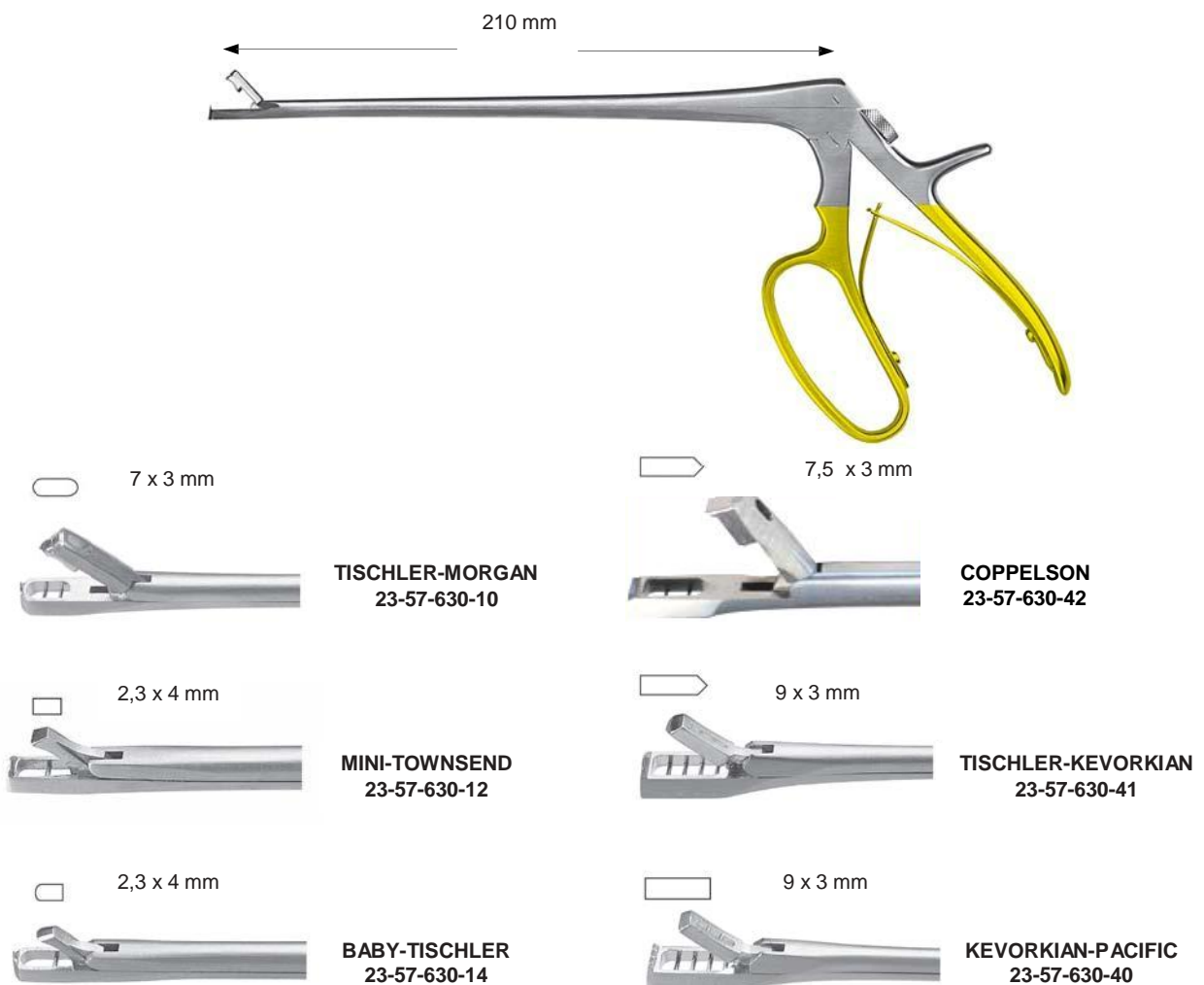
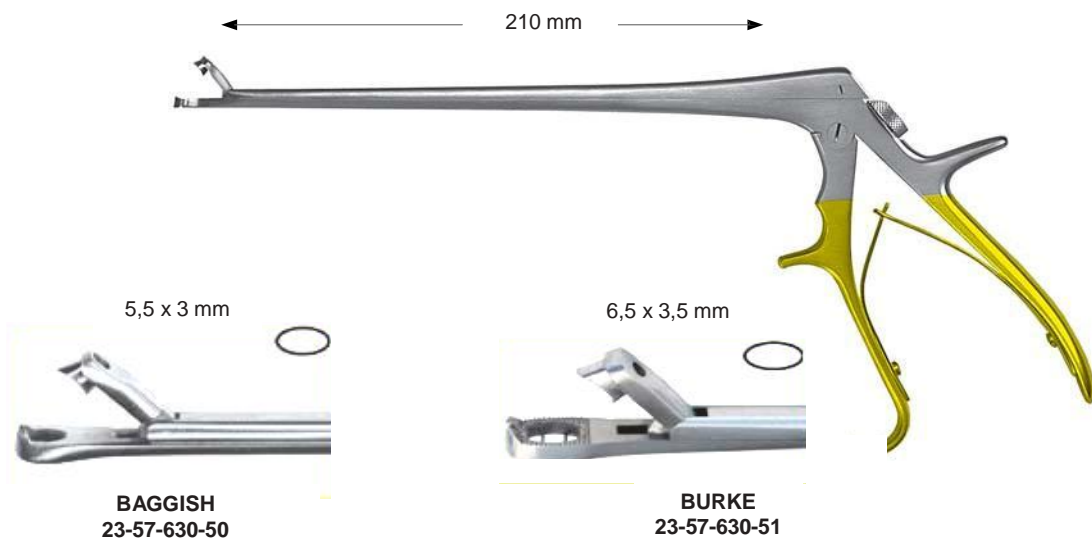



WRIGLEY
 28,0 cm, 11"
 23-58-056-28



SIMPSON
 23,0 cm, 9³/₄" 23-58-034-23
 30,0 cm, 11³/₄" 23-58-034-30



SIMPSON-BRAUN
 33,0 cm, 13" 23-58-036-33
 36,0 cm, 14¹/₈" 23-58-036-36



SIMPSON-LUIKART
 36,0 cm, 14¹/₈"
 23-58-046-36



DE LEE
 30,0 cm, 11³/₄"
 23-58-058-30



DE LEE
 36,0 cm, 14¹/₈"
 23-58-058-36



DE LEE
 39,0 cm, 15³/₈"
 23-58-058-39



MC LEAN
 36,0 cm, 14 $\frac{1}{8}$ "
 23-58-044-36



KIELAND
 41,0 cm, 16"
 23-58-052-41



KIELAND-LUIKART
 40,0 cm, 15 $\frac{3}{4}$ "
 23-58-054-40



ELLIOT
 32,0 cm, 12 $\frac{1}{2}$ " 23-58-080-32
 38,0 cm, 15 $\frac{3}{8}$ " 23-58-080-38



NAEGELE
 36,0 cm, 14 $\frac{1}{8}$ " 23-58-084-36
 40,0 cm, 15 $\frac{3}{4}$ " 23-58-084-40



PIPER
 44,0 cm, 17 $\frac{1}{4}$ "
 23-58-060-44



GREEN-ARMYTAGE
 21,0 cm, 8 $\frac{1}{4}$ "
 23-58-200-21



PESTALOZZA
 30,0 cm, 11 $\frac{3}{4}$ "
 23-58-252-30



SAENGER
 27,0 cm, 10 $\frac{5}{8}$ "
 23-58-260-27



SAENGER
 27,0 cm, 10 $\frac{5}{8}$ "
 23-58-261-27



WINTER
 28,0 cm, 11"



Fig. 1
 23-58-244-01



Fig. 2
 23-58-244-02

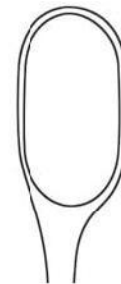

Fig. 3
 23-58-244-03



Fig. 1
 23-58-245-01



Fig. 2
 23-58-245-02



Fig. 3
 23-58-245-03

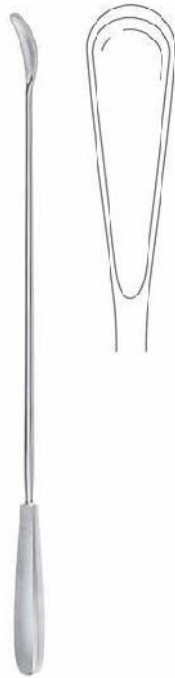

WALLICH
42,0 cm, 16½"
23-58-300-42



MARTIN
34,0 cm, 13¾"
23-58-600-34



SAENGER
27,0 cm, 10¾"
23-58-236-01



SAENGER
27,0 cm, 10¾"
23-58-237-01

Vorbereitung, Dermatologie
Preparation, Dermatology
Préparation, Dermatologie
Preparación, Dermatología
Препарирование, дерматология



Hautstanzen, Nagel Instrumente Dermal
 Punches, Nail Instruments Poinçonnage
 cutanés, Trépanos cutanés Trépanos
 cutáneos, Instrumentos para uñas
 Пробойники дерматологические, инструменты для ногтей

Lupusküretten
 Lupus curettes
 Curettes pour les lupus
 Curetas para lupus
 lupus кюретка



PIFFARD
 14,0 cm, 5³/₄"



KEYES
 12,0 cm, 4³/₄"



KEYES
 12,0 cm, 4³/₄"
 25-59-210-00



25-59-400-00 komplett,
 complete, complet,
 completo, в наборе



UNNA
14,0 cm, 5 $\frac{3}{4}$ "
25-59-000-14



UNNA
14,0 cm, 5 $\frac{3}{4}$ "
25-59-002-14



SAALFELD
10,0 cm, 4"
25-59-010-10



SAALFELD
14,0 cm, 5 $\frac{3}{4}$ "
25-59-012-14



SCHAMBERG
10,0 cm, 4"
25-59-020-10



WALTON
14,0 cm, 5 $\frac{3}{4}$ "
25-59-030-14



FOX
14,0 cm, 5 $\frac{3}{4}$ "

Lupusküretten
Lupus curettes
Curettes pour les lupus
Curetas para lupus
лупус кюретка

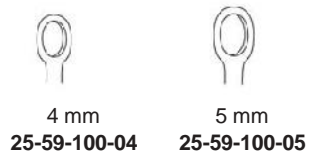



25-59-420-01

17,0 cm, 6 $\frac{3}{4}$ "
 25-59-420-17



25-59-430-01

WALTON
 16,0 cm, 6 $\frac{1}{4}$ "
 25-59-430-16



RADOLF
 13,5 cm, 5 $\frac{5}{8}$ "
 25-59-500-13



13,5 cm, 5 $\frac{3}{8}$ "
 25-59-510-13



13,0 cm, 5"
 25-59-600-13



14,0 cm, 5 $\frac{1}{2}$ "

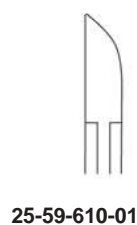

25-59-610-01



25-59-610-02

Knochenchirurgie
Bone Surgery
Chirurgia ossea
Cirurgía ósea
Костная хирургия



Scharfe Löffel Bone
Curettes Curettes
tranchantes
Cucharillas cortantes
Костные кюретки



SCHEDE
17,0 cm, 6¾"

Fig. 000
27-62-467-03

Fig. 00
27-62-467-02

Fig. 0
27-62-467-01

Fig. 1
27-62-467-11

Fig. 2
27-62-467-12

Fig. 3
27-62-467-13

Fig. 4
27-62-467-14

Fig. 0000
27-62-469-04

Fig. 000
27-62-469-03

Fig. 00
27-62-469-02

Fig. 0
27-62-469-01

Fig. 1
27-62-469-11

Fig. 2
27-62-469-02

Fig. 3
27-62-469-13

Fig. 4
27-62-469-14

Fig. 5
27-62-469-15

Fig. 6
27-62-469-16



VOLKMANN
17,0 cm, 6¾"



BRUNS
17,0 cm, 6¾"

Fig. 0000
27-62-472-04

Fig. 000
27-62-472-03

Fig. 000
27-62-472-02

Fig. 0
27-62-472-01

Fig. 1
27-62-472-11

Fig. 2
27-62-472-12

Fig. 3
27-62-472-13

Fig. 4
27-62-472-14

Fig. 5
27-62-472-15

Fig. 6
27-62-472-16

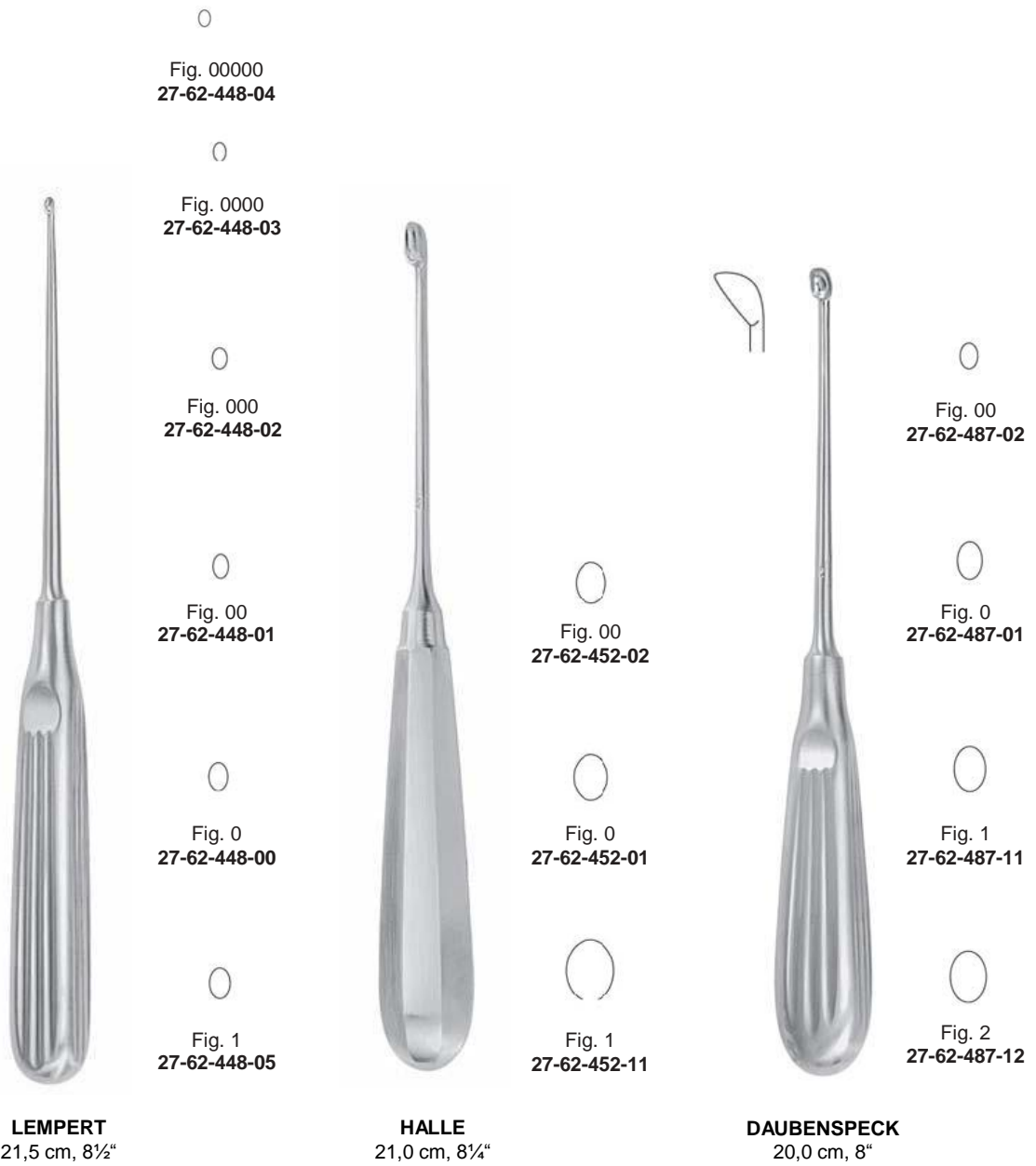

Scharfe Löffel Bone
 Curettes Curettes
 tranchantes
 Cucharillas cortantes
 Костные кюретки

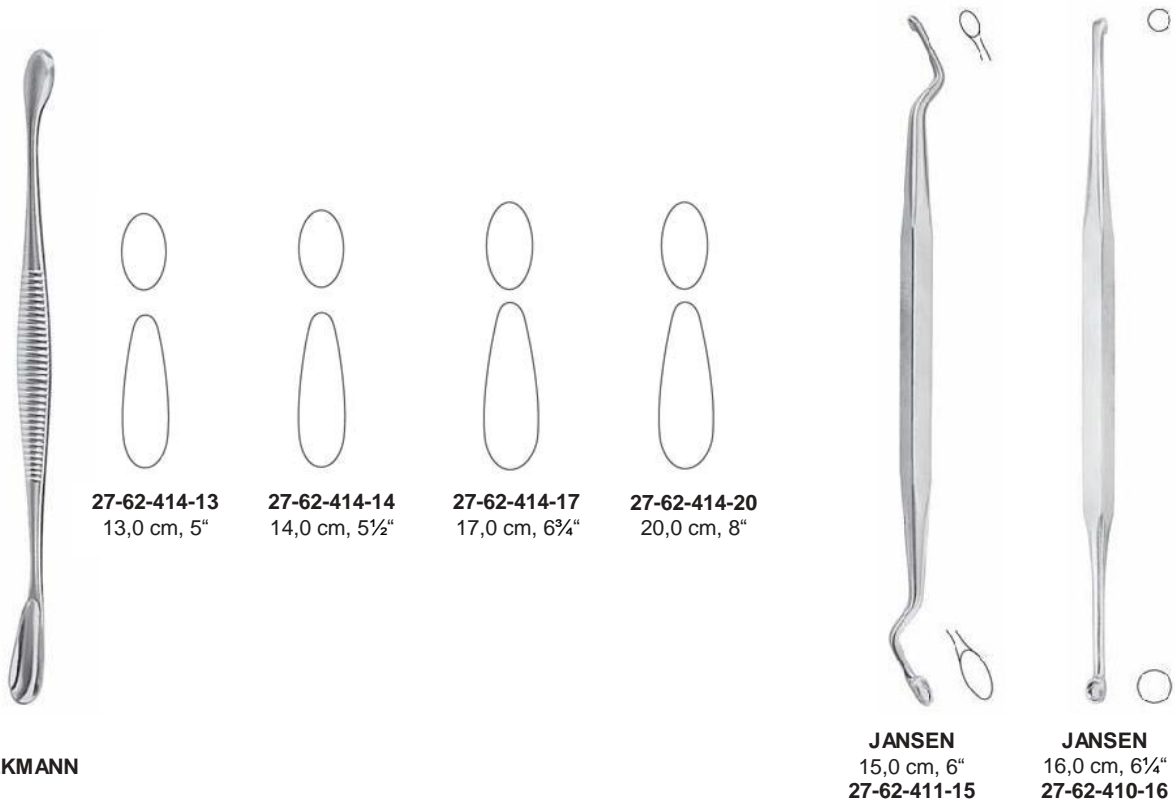
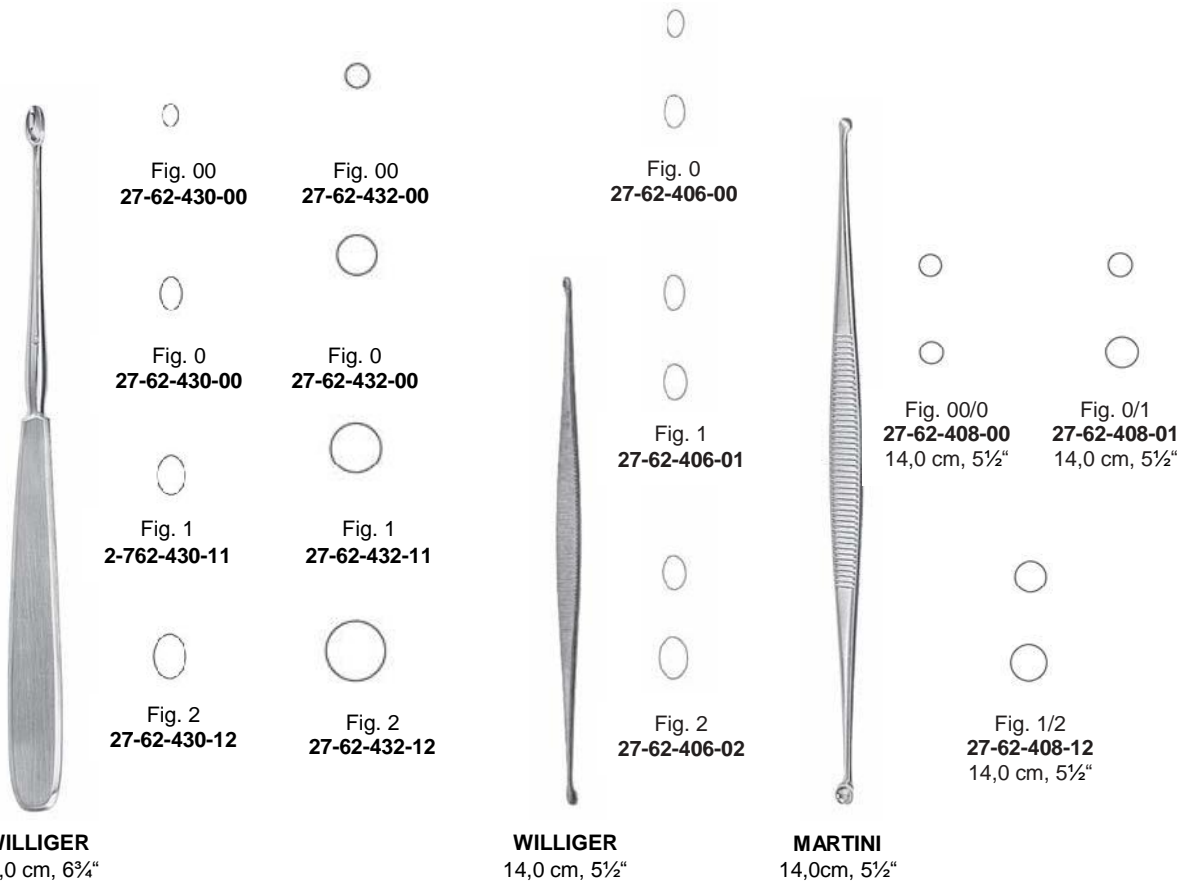



WATSON-CHEYNE
 17,5 cm, 6 $\frac{5}{8}$ "
 27-63-501-17



WILLIGER
 13,0 cm, 5"
 27-63-512-13



WILLIGER
 16,0 cm, 6 $\frac{1}{2}$ "
 27-63-512-16



WILLIGER
 17,0 cm, 6 $\frac{3}{4}$ "
 27-63-512-17



MC DONALD
 19,0 cm, 7 $\frac{1}{2}$ "
 27-63-440-19



LANGENBECK
 20,0 cm, 8"
 27-63-520-08



LANGENBECK
 20,0 cm, 8"
 27-63-520-10



8 mm
 27-63-465-01

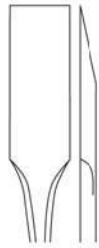

7 mm
 27-63-465-02



stumpf
 blunt
 mousse
 romo
 тупые

7 mm
 27-63-465-03



halbscharf
 half-sharp
 demi-pointu
 semi-agudos
 полуострые

7 mm
 27-63-465-04



scharf
 sharp
 pointu
 agudos
 острые



5 mm
 27-63-476-15



27

ADSON
 17,0 cm, 6¾"

KÖNIG
 15,5 cm, 6"



LAMBOTTE
 21,0 cm, 8¼"

5 mm
 27-63-477-05



10 mm
 27-63-477-10



15 mm
 27-63-477-15



20 mm
 27-63-077-20



25 mm
 27-63-477-25



12,5 mm



FARABEUF
 15,0 cm, 6"
 27-63-478-15



12,5 mm



FARABEUF
 15,0 cm, 6"
 27-63-479-15





LANGENBECK
19,0 cm, 7½"
27-63-472-19



SEDILLOT
21,0 cm, 8¼"
27-63-488-21



WILLIGER
16,0 cm, 6¼"

| | |
|------|--------------|
| 4 mm | 27-63-480-04 |
| 6 mm | 27-63-480-06 |
| 8 mm | 27-63-480-08 |



DOYEN
17,0 cm, 6¾"
27-63-485-17

für Kinder
for children
pour enfants
para niños
для детей



DOYEN
17,0 cm, 6¾"
27-63-487-17



DOYEN
17,0 cm, 6¾" 27-63-481-17
24,0 cm, 9½" 27-63-481-24

für Erwachsene
for adults
pour adultes
para adultos
для взрослых



DOYEN
17,0 cm, 6¾" 27-63-483-17
24,0 cm, 9½" 27-63-483-24

Flachmeißel, Hohlmeißel, Osteotome
 Chisels, Gouges, Osteotomes
 Ciseaux-burins, Gouges, Ostéotomes
 Cinceles, Gubias, Osteótomos
 Долота для костей, остеотомы



2,0 mm **27-64-300-02**
 3,0 mm **27-64-300-03**
 4,0 mm **27-64-300-04**
 5,0 mm **27-64-300-05**
 6,0 mm **27-64-300-06**
 8,0 mm **27-64-300-08**
 10,0 mm **27-64-300-10**
 12,0 mm **27-64-300-12**
 14,0 mm **27-64-300-14**
 16,0 mm **27-64-300-16**

13,5 cm, 5 $\frac{3}{8}$ "



4,0 mm **27-64-301-04**
 6,0 mm **27-64-301-06**
 18,0 mm **27-64-301-08**
 10,0 mm **27-64-301-10**
 12,0 mm **27-64-301-12**
 14,0 mm **27-64-301-14**
 16,0 mm **27-64-301-16**

13,5 cm, 5 $\frac{3}{8}$ "



4,0 mm **27-64-302-04**
 6,0 mm **27-64-302-06**
 8,0 mm **27-64-302-08**
 10,0 mm **27-64-302-10**
 12,0 mm **27-64-302-12**
 14,0 mm **27-64-302-14**
 16,0 mm **27-64-302-16**

13,5 cm, 5 $\frac{3}{8}$ "

27



2,0 mm **27-64-333-02**
 3,0 mm **27-64-333-03**
 4,0 mm **27-64-333-04**
 5,0 mm **27-64-333-05**
 6,0 mm **27-64-333-06**
 7,0 mm **27-64-333-07**
 8,0 mm **27-64-333-08**

PARTSCH
 11,5 cm, 4 $\frac{1}{2}$ "



2,0 mm **27-64-334-02**
 3,0 mm **27-64-334-03**
 4,0 mm **27-64-334-04**
 5,0 mm **27-64-334-05**
 6,0 mm **27-64-334-06**
 7,0 mm **27-64-334-07**
 8,0 mm **27-64-334-08**

PARTSCH
 13,5 cm, 5 $\frac{3}{8}$ "



2,0 mm **27-64-335-02**
 3,0 mm **27-64-335-03**
 4,0 mm **27-64-335-04**
 5,0 mm **27-64-335-05**
 6,0 mm **27-64-335-06**
 7,0 mm **27-64-335-07**
 8,0 mm **27-64-335-08**

PARTSCH
 17,0 cm, 6 $\frac{3}{4}$ "



| | |
|--------|---------------------|
| 2,0 mm | 27-64-337-02 |
| 3,0 mm | 27-64-337-03 |
| 4,0 mm | 27-64-337-04 |
| 5,0 mm | 27-64-337-05 |
| 6,0 mm | 27-64-337-06 |
| 7,0 mm | 27-64-337-07 |
| 8,0 mm | 27-64-337-08 |

PARTSCH
11,5 cm, 5 $\frac{3}{4}$ "



| | |
|--------|---------------------|
| 2,0 mm | 27-64-336-02 |
| 3,0 mm | 27-64-336-03 |
| 4,0 mm | 27-64-336-04 |
| 5,0 mm | 27-64-336-05 |
| 6,0 mm | 27-64-336-06 |
| 7,0 mm | 27-64-336-07 |
| 8,0 mm | 27-64-336-08 |

PARTSCH
13,5 cm, 5 $\frac{3}{4}$ "



| | |
|--------|---------------------|
| 2,0 mm | 27-64-332-02 |
| 3,0 mm | 27-64-332-03 |
| 4,0 mm | 27-64-332-04 |
| 5,0 mm | 27-64-332-05 |
| 6,0 mm | 27-64-332-06 |
| 7,0 mm | 27-64-332-07 |
| 8,0 mm | 27-64-332-08 |

PARTSCH
17,0cm, 5 $\frac{3}{4}$ "



STILLE
20,0 cm, 8"



Fig. 1

gerade, straight,
droit, recta, прямые



Fig. 2

gebogen, curved, curva,
arqué, изогнутые



Fig. 3

fein, small, fin,
fin, тонкий

| | Fig. 1 | Fig. 2 | Fig. 3 |
|---------|---------------------|---------------------|---------------------|
| 6,0 mm | 27-64-360-06 | - | 27-64-361-06 |
| 8,0 mm | 27-64-360-08 | - | 27-64-361-08 |
| 12,0 mm | 27-64-360-12 | 27-64-359-12 | 27-64-361-12 |
| 10,0 mm | 27-64-360-10 | 27-64-359-10 | 27-64-361-10 |
| 15,0 mm | 27-64-360-15 | 27-64-359-15 | 27-64-361-15 |
| 20,0 mm | 27-64-360-20 | 27-64-359-20 | 27-64-361-20 |
| 25,0 mm | 27-64-360-25 | 27-64-359-25 | 27-64-361-25 |
| 30,0 mm | 27-64-360-30 | 27-64-359-30 | 27-64-361-30 |

Flachmeißel, Hohlmeißel, Osteotome
 Chisels, Gouges, Osteotomes
 Ciseaux-burins, Gouges, Ostéotomes
 Cinceles, Gubias, Osteótomos
 Долота для костей, остеотомы



| | | |
|---------|---------------------|---------------------|
| 6,0 mm | <u>27-64-362-06</u> | <u>27-64-363-06</u> |
| 8,0 mm | <u>27-64-362-08</u> | <u>27-64-363-08</u> |
| 10,0 mm | <u>27-64-362-10</u> | <u>27-64-363-10</u> |
| 12,0 mm | <u>27-64-362-12</u> | <u>27-64-363-12</u> |
| 15,0 mm | <u>27-64-362-15</u> | <u>27-64-363-15</u> |
| 20,0 mm | <u>27-64-362-20</u> | <u>27-64-363-20</u> |
| 25,0 mm | <u>27-64-362-25</u> | <u>27-64-363-25</u> |
| 30,0 mm | <u>27-64-362-30</u> | <u>27-64-363-30</u> |

STILLE
 20,0 cm, 8"



| | |
|---------|---------------------|
| 14,0 mm | <u>27-64-318-04</u> |
| 16,0 mm | <u>27-64-318-06</u> |
| 18,0 mm | <u>27-64-318-08</u> |
| 10,0 mm | <u>27-64-318-10</u> |
| 12,0 mm | <u>27-64-318-12</u> |
| 14,0 mm | <u>27-64-318-14</u> |

ALEXANDER
 18,0 cm, 7"



| | |
|---------|---------------------|
| 2,0 mm | <u>27-64-319-02</u> |
| 4,0 mm | <u>27-64-319-04</u> |
| 6,0 mm | <u>27-64-319-06</u> |
| 8,0 mm | <u>27-64-319-08</u> |
| 10,0 mm | <u>27-64-319-10</u> |
| 12,0 mm | <u>27-64-319-12</u> |
| 14,0 mm | <u>27-64-319-14</u> |

ALEXANDER
 18,0 cm, 7"



16,0 mm **27-64-350-06**
 19,0 mm **27-64-350-09**
 13,0 mm **27-64-350-13**
 16,0 mm **27-64-350-16**
 19,0 mm **27-64-350-19**
 25,0 mm **27-64-350-25**
 32,0 mm **27-64-350-32**

SMITH-PETERSEN
 20,0 cm, 8"



16,0 mm **27-64-351-06**
 19,0 mm **27-64-351-09**
 13,0 mm **27-64-351-13**
 16,0 mm **27-64-351-16**
 19,0 mm **27-64-351-19**
 25,0 mm **27-64-351-25**
 32,0 mm **27-64-351-32**

SMITH-PETERSEN
 20,0 cm, 8"



19,0 mm **27-64-352-09**
 14,0 mm **27-64-352-14**
 16,0 mm **27-64-352-16**
 19,0 mm **27-64-352-19**
 25,0 mm **27-64-352-25**
 32,0 mm **27-64-352-32**

SMITH-PETERSEN
 20,0 cm, 8"



19,0 mm **27-64-353-09**
 14,0 mm **27-64-353-14**
 16,0 mm **27-64-353-16**
 19,0 mm **27-64-353-19**
 25,0 mm **27-64-353-25**
 32,0 mm **27-64-353-32**

SMITH-PETERSEN
 20,0 cm, 8"

Flachmeißel, Hohlmeißel, Osteotome, Hämmer
 Chisels, Gouges, Osteotomes, Mallets
 Ciseaux-burins, Gouges, Ostéotomes, Maillets
 Cinceles, Gubias, Osteótomos, Martillos
 Долота для костей, остеотомы, молотки



16,0 mm 27-64-451-06
 15,0 mm 27-64-451-15
 20,0 mm 27-64-451-20
 25,0 mm 27-64-451-25
 30,0 mm 27-64-451-30
 38,0 mm 27-64-451-38
 44,0 mm 27-64-451-44
 50,0 mm 27-64-451-50

LAMBOTTE
 24,0 cm, 9½"



2,0 mm 27-64-446-02
 3,0 mm 27-64-446-04
 4,0 mm 27-64-446-15
 6,0 mm 27-64-446-20
 8,0 mm 27-64-446-25
 10,0 mm 27-64-446-30
 12,0 mm 27-64-446-38
 15,0 mm 27-64-446-44

MINI-LAMBOTTE
 12,5 cm, 9½"



4,0 mm 27-64-450-04
 6,0 mm 27-64-450-06
 8,0 mm 27-64-450-08
 10,0 mm 27-64-450-10
 13,0 mm 27-64-450-13
 16,0 mm 27-64-450-16
 18,0 mm 27-64-450-18
 20,0 mm 27-64-450-20
 25,0 mm 27-64-450-25
 30,0 mm 27-64-450-30
 38,0 mm 27-64-450-38
 44,0 mm 27-64-450-44
 50,0 mm 27-64-450-50

LAMBOTTE
 24,0 cm, 9½"



Ø 30 mm
 220 g

COLLIN
 20,0 cm, 8"
 27-61-132-20



Ø 22 mm
 200 g

mit Bleifüllung lead filled
 head remplissage de
 plomb cabezal relleno de
 plomo
 со свинцовым наполнением

PARTSCH
 18,0 cm, 7"
 27-61-145-18



Ø 45 mm
 300 g

BERGMANN
 24,0 cm, 9½"
 27-61-201-24

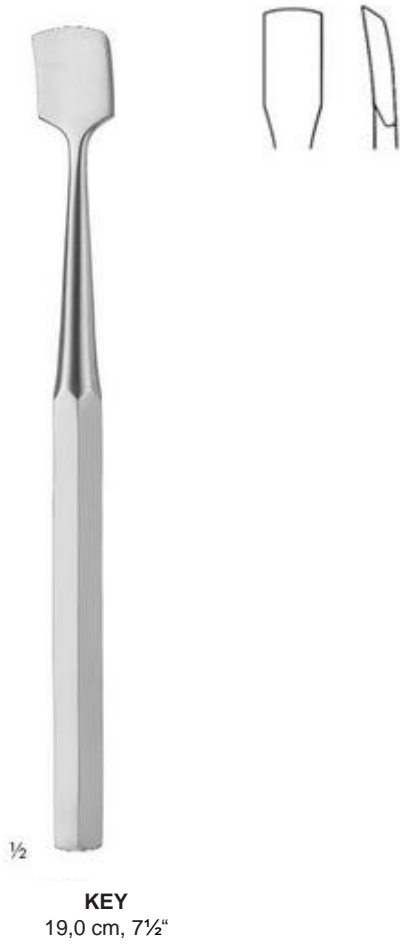

- 6,0 mm **27-63-370-06**
- 10,0 mm **27-63-370-10**
- 12,0 mm **27-63-370-12**
- 13,0 mm **27-63-370-13**
- 19,0 mm **27-63-370-19**
- 25,0 mm **27-63-370-25**

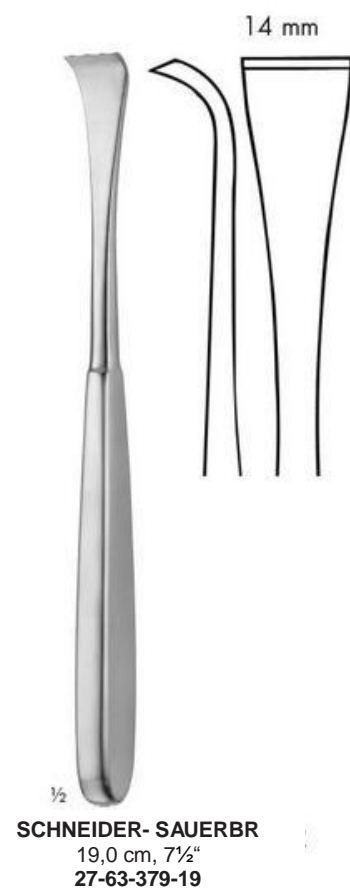
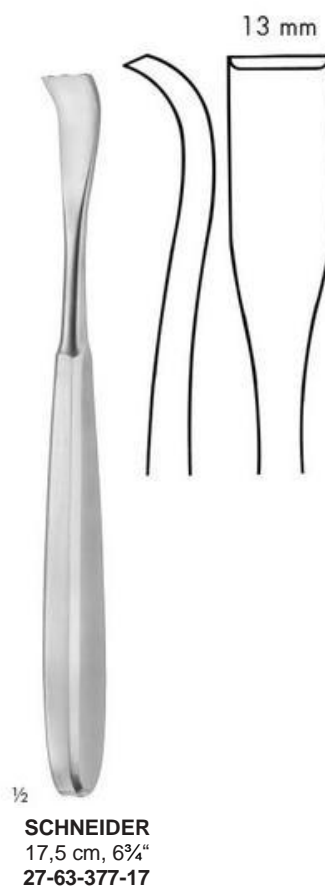

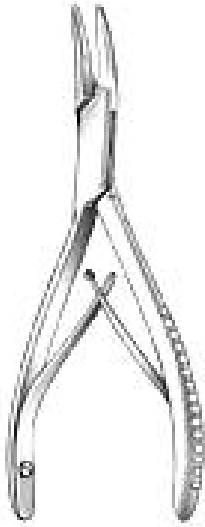

MINI-FRIEDMANN
 12,0 cm
 27-66-201-12



FRIEDMANN
 15,0 cm
 27-66-202-15



FRIEDMANN
 14,0 cm, 5½
 27-66-202-14

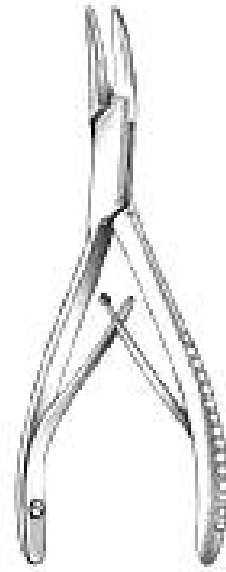

FRIEDMANN
 14,0 cm, 5½
 27-66-203-14

27



STELLBRINK
 17,0 cm/6¾", 2mm



27-66-205-01



27-66-205-02



CLEVELAND



1/1

14,0 cm, 5½
 27-66-207-14



1/1

17,0 cm, 6¾"
 27-66-207-17



JANSEN
 18,0 cm, 7"



27-66-208-18



27-66-208-19



27-66-209-18



Hohlmeisselzangen
Bone Rongeurs
Pincas-gouges
Pinzas gubias
Щипцы для костей



OLIVECRONA
20,0 cm, 8"
27-66-210-20



UNIVERSAL
13,5 cm, 5"
27-66-211-13



MEAD
16,5 cm, 6½"



27-66-215-01



27-66-215-02

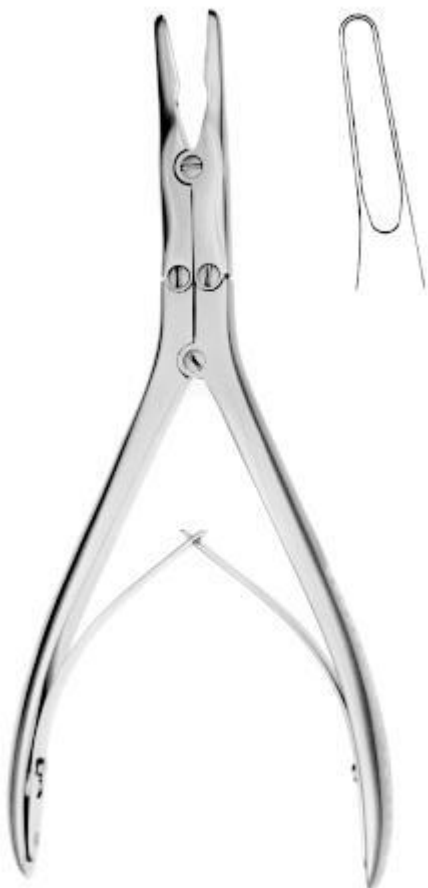

BEYER
18,0 cm, 7"
27-66-217-17



BEYER
17,0 cm, 6¾"



2mm
27-66-218-02



3mm
27-66-218-03



ZUFAL-ALEXANDER
 19,0 cm, 7½"
 27-66-219-19



HARTMANN
 18,5 cm, 7½"
 27-66-221-18

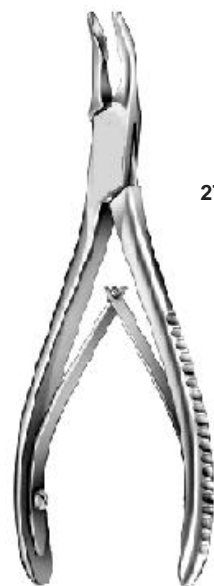

BLUMENTHAL
 15,5 cm, 6"

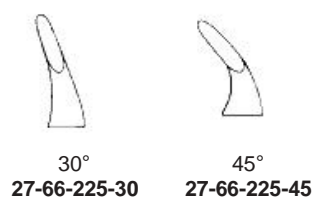

LUER
 17,0 cm, 6¾"



LUER
 15,0 cm, 6"



BACON
 20,0 cm, 8"
 27-66-241-20

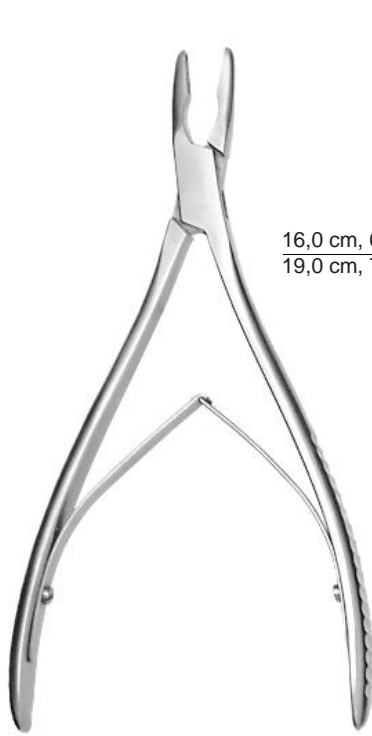

16,0 cm, 6½" 27-66-236-16 27-66-237-16
19,0 cm, 7½" 27-66-236-19 27-66-237-19

LEMPERT

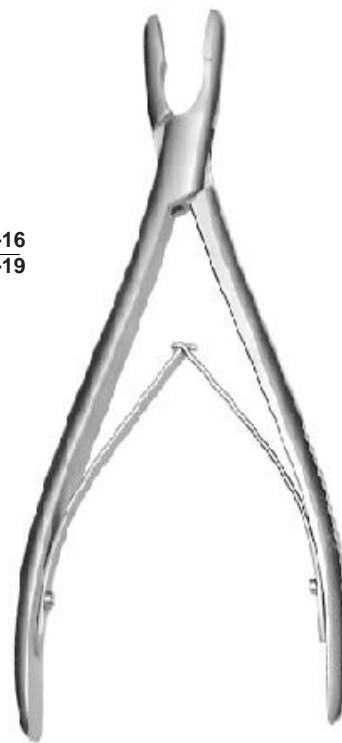

27-66-238-20

27-66-239-20

mit Zähne-with teeth
27-66-240-20

ADSON
20,0 cm 8"



HAKANSSON
17,0 cm, 6¾"
27-66-240-17



BANE
18,0 cm, 7"
27-66-242-18



DEFOURMENTEL
19,0 cm, 7½"
27-66-260-19



MARQUARDT
20,0 cm, 8"
27-66-301-20



MAYFIELD
 17,0 cm, 6¾" 27-66-303-17
 20,0 cm, 8" 27-66-303-20



BÖHLER
 15,0 cm, 6"

3,0 mm 27-66-306-01
 4,0 mm 27-66-306-02
 5,0 mm 27-66-306-03



3,0 mm 27-66-307-01
 4,0 mm 27-66-307-02
 5,0 mm 27-66-307-03



KLEINERT-KUTZ
 15,0 cm, 6"



2 x 13 mm
 27-66-311-02"



3 x 8 mm
 27-66-311-03"



RUSKIN

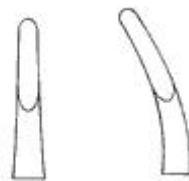

15,0 cm, 6"

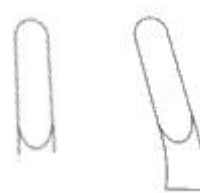

18,0 cm, 7"



23,0 cm, 9"

| | | | | | |
|--------|--------------|--------------|--------------|--------------|--------------|
| 2,0 mm | 27-66-315-15 | 27-66-317-15 | - | - | - |
| 3,0 mm | 27-66-316-15 | 27-66-318-15 | - | - | - |
| 4,0 mm | - | - | 27-66-323-18 | 27-66-327-18 | - |
| 5,0 mm | - | - | 27-66-324-18 | 27-66-328-18 | 27-66-331-18 |
| 6,0 mm | - | - | 27-66-325-18 | 27-66-329-18 | 27-66-332-18 |
| 7,0 mm | - | - | 27-66-326-18 | 27-66-330-18 | 27-66-364-18 |



BEYER
 18,0 cm, 7"



27-66-317-18



27-66-319-18



ZAUFAL-JANSEN
 18,0 cm, 7"
 27-66-321-18



ROETTGEN-RUSKIN
 24,0 cm, 9½"
 27-66-331-24



SEMB
 22,5 cm, 9" 27-66-341-22
 27,0 cm, 10½" 27-66-341-27



STILLE-RUSKIN
 23,0 cm, 9"
 27-66-345-23



LEKSELL-STILLE
 24,0 cm, 9½"

| Maulbreite | bite |
|------------|--------------|
| 3 x 16 mm | 27-64-448-03 |
| 4 x 16 mm | 27-64-448-04 |
| 5 x 16 mm | 27-64-448-05 |
| 6 x 16 mm | 27-64-448-06 |
| 7 x 16 mm | 27-64-448-07 |
| 8 x 16 mm | 27-64-448-08 |

Hohlmeisselzangen
Bone Rongeurs
Pinces-gouges
Pinzas gubias
Щипцы для костей



| Maulbreite bite | |
|--------------------|---------------------|
| 3 x 16 mm | 27-64-449-03 |
| 4 x 16 mm | 27-64-449-04 |
| 5 x 16 mm | 27-64-449-05 |
| 6 x 16 mm | 27-64-449-06 |
| 7 x 16 mm | 27-64-449-07 |
| 8 x 16 mm | 27-64-449-08 |

LEKSELL
24,0 cm, 9½"



DALE
35,0 cm, 13½"
3,0 mm **27-66-350-03**
8,0 mm **27-66-350-08**



STILLE
23,0 cm, 9"
5 x 14 mm **27-66-358-23**
6 x 14 mm **27-66-359-23**



STILLE-LUER

22,0 cm **27-66-352-22**
26,0 cm **27-66-352-26**
27,0 cm **27-66-354-27**

22,0 cm **27-66-353-22**
26,0 cm **27-66-353-26**
27,0 cm **27-66-355-27**



SAUERBRUCH



27-66-356-01

27-66-356-02



FRYKHOLM
 24,0 cm, 9½"
 4 mm **27-66-357-04**
 8 mm **27-66-357-08**



SYPERT
 36,0 cm, 14¾"

| | ohne Zähne without teeth | mit Zähne with teeth |
|-------|-----------------------------|-------------------------|
| 3 mm | 27-66-359-03 | - |
| 4 mm | 27-66-359-04 | - |
| 5 mm | 27-66-359-05 | - |
| 8 mm | 27-66-359-08 | 27-66-358-08 |
| 12 mm | 27-66-359-12 | 27-66-358-12 |



ECHLIN
 23,0 cm, 9"
 2 x 10 mm **27-66-361-01**
 3 x 10 mm **27-66-361-02**
 4 x 10 mm **27-66-361-03**



SMITH-PETERSEN
 24,0 cm, 9½"

| | | | |
|--------|---------------------|---------------------|---------------------|
| 3,0 mm | 27-66-368-03 | 27-66-367-03 | 27-66-369-03 |
| 4,0 mm | | 27-66-367-04 | 27-66-369-04 |
| 5,0 mm | | 27-66-367-05 | 27-66-369-05 |

Hohlmeisselzangen
 Bone Rongeurs
 Pincès-gouges
 Pinzas gubias
 Щипцы для костей



PENNYBACKER
 20,0 cm, 8"
 27-66-372-20



FALCONER
 20,5 cm, 8¹/₆"
 6 mm 27-66-373-20



TROTTER
 20,5 cm, 8¹/₆"
 10 mm 27-66-374-20



WILMS
 20,5 cm, 8¹/₆"
 27-66-375-20



NORTHFIELD
 20,5 cm, 8¹/₆"
 27-66-376-20

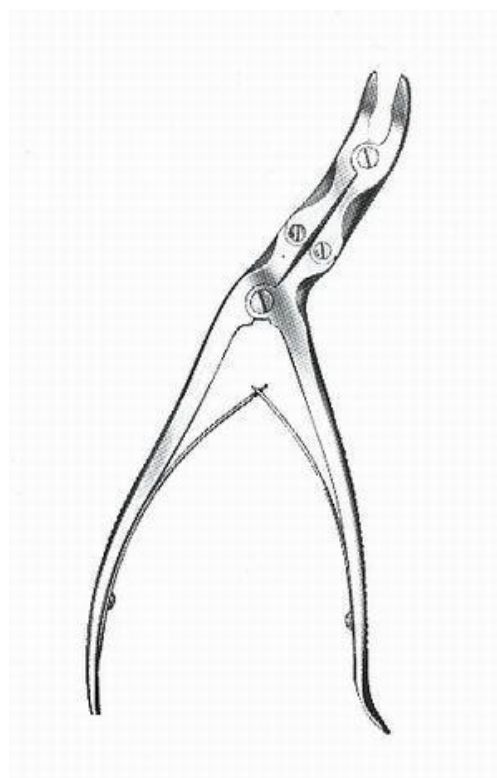

SCAGLIETTI
 26,0 cm, 10¹/₂" Right
 27-66-370-26
 Left 27-66-371-26



COTTLE KAZANJIAN
 19,0 cm, 7½"
 27-66-500-19

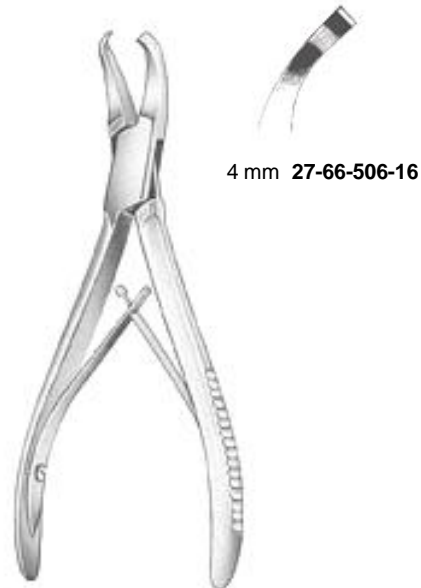

CLEVELAND-GARDNER
 16,0 cm, 6½"
 4 mm 27-66-505-16

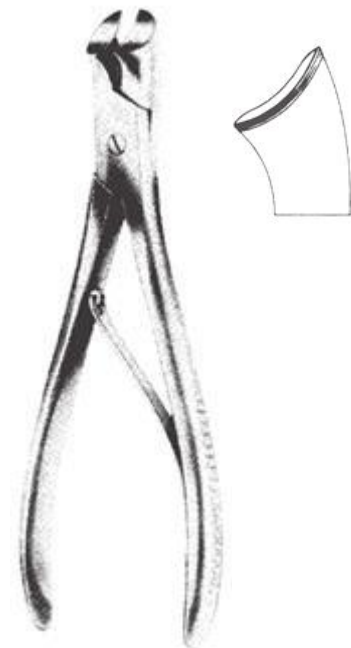

MARKWALDER
 20,0 cm, 8"
 27-66-507-20



LISTON
 Gerade-straight gebogen-curved
 14,0 cm 27-66-520-14 27-66-521-14
 17,0 cm 27-66-520-17 27-66-521-17
 19,0 cm 27-66-520-19 27-66-521-19
 22,0 cm 27-66-520-22 27-66-521-22



LISTON-LITTAUER
 15,0 cm, 6"
 27-66-524-15



CLEVELAND
 15,0 cm 27-66-527-15
 17,0 cm 27-66-527-17

Knochensplitterzangen
Bone cutting forceps
Pinces-gouges
Pinzas gubias
Щипцы для костей

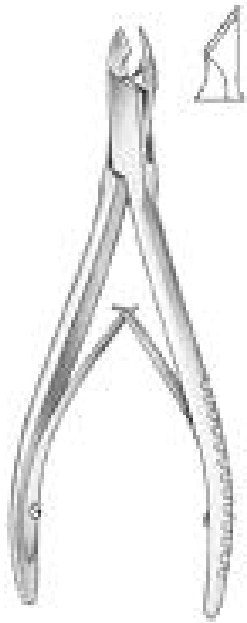

12,0 cm, 4½"
 27-66-529-12



RUSKIN-LISTON
 Gerade-straight gebogen-curved
 18,5 cm 7¼" 27-66-602-18 27-66-603-18



RUSKIN
 Gerade-straight gebogen-curved
 18,0 cm 7" 27-66-604-18 27-66-605-18



SEMB
 24,0 cm 9"
 27-66-633-24



MC INDOE
 17,0 cm 7"
 gebogen-curved
 27-66-607-17



BÖHLER (WALTON-LISTON)
 Gerade-straight gebogen-curved
 15,0 cm 5¾" 27-66-608-15 27-66-609-15



STILLE-LISTON

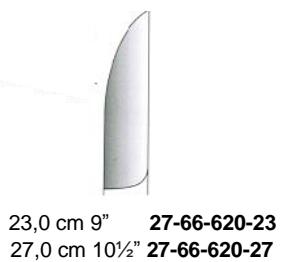

23,0 cm 9" 27-66-620-23
27,0 cm 10½" 27-66-620-27

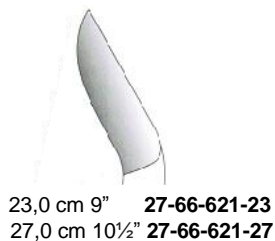

23,0 cm 9" 27-66-621-23
27,0 cm 10½" 27-66-621-27

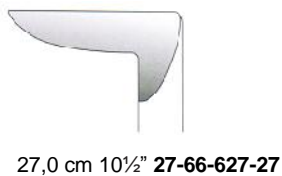

27,0 cm 10½" 27-66-627-27



KLEINERT KUTZ
15,0 cm, 6"



27-66-634-15



27-66-635-15

FERRIS-SMITH-KERRISON



Bandscheibenstanzen / Intervertebral Disc Rongeurs

| | | | |
|--------------|-----------------------------|--------------|-----------------------------|
| 46-71-067-01 | 1mm 6" 90° upwards cutting | 46-71-071-07 | 3mm 11" 90° upwards cutting |
| 46-71-067-02 | 1mm 7" 90° upwards cutting | 46-71-071-08 | 3mm 12" 90° upwards cutting |
| 46-71-067-03 | 1mm 8" 90° upwards cutting | 46-71-071-09 | 3mm 13" 90° upwards cutting |
| 46-71-067-04 | 1mm 9" 90° upwards cutting | 46-71-071-10 | 4mm 11" 90° upwards cutting |
| 46-71-067-05 | 2mm 6" 90° upwards cutting | 46-71-071-11 | 4mm 12" 90° upwards cutting |
| 46-71-067-06 | 2mm 7" 90° upwards cutting | 46-71-071-12 | 4mm 13" 90° upwards cutting |
| 46-71-067-07 | 2mm 8" 90° upwards cutting | 46-71-071-13 | 5mm 11" 90° upwards cutting |
| 46-71-067-08 | 2mm 9" 90° upwards cutting | 46-71-071-14 | 5mm 12" 90° upwards cutting |
| 46-71-067-09 | 3mm 6" 90° upwards cutting | 46-71-071-15 | 5mm 13" 90° upwards cutting |
| 46-71-067-10 | 3mm 7" 90° upwards cutting | 46-71-071-16 | 6mm 11" 90° upwards cutting |
| 46-71-067-11 | 3mm 8" 90° upwards cutting | 46-71-071-17 | 6mm 12" 90° upwards cutting |
| 46-71-067-12 | 3mm 9" 90° upwards cutting | 46-71-071-18 | 6mm 13" 90° upwards cutting |
| 46-71-067-13 | 4mm 6" 90° upwards cutting | 46-71-073-01 | 1mm 11" 90° downwards |
| 46-71-067-14 | 4mm 7" 90° upwards cutting | 46-71-073-02 | 1mm 12" 90° downwards |
| 46-71-067-15 | 4mm 8" 90° upwards cutting | 46-71-073-03 | 1mm 13" 90° downwards |
| 46-71-067-16 | 4mm 9" 90° upwards cutting | 46-71-073-04 | 2mm 11" 90° downwards |
| 46-71-067-17 | 5mm 6" 90° upwards cutting | 46-71-073-05 | 2mm 12" 90° downwards |
| 46-71-067-18 | 5mm 7" 90° upwards cutting | 46-71-073-06 | 2mm 13" 90° downwards |
| 46-71-067-19 | 5mm 8" 90° upwards cutting | 46-71-073-07 | 3mm 11" 90° downwards |
| 46-71-067-20 | 5mm 9" 90° upwards cutting | 46-71-073-08 | 3mm 12" 90° downwards |
| 46-71-067-21 | 6mm 6" 90° upwards cutting | 46-71-073-09 | 3mm 13" 90° downwards |
| 46-71-067-22 | 6mm 7" 90° upwards cutting | 46-71-073-10 | 4mm 11" 90° downwards |
| 46-71-067-23 | 6mm 8" 90° upwards cutting | 46-71-073-11 | 4mm 12" 90° downwards |
| 46-71-067-24 | 6mm 9" 90° upwards cutting | 46-71-073-12 | 4mm 13" 90° downwards |
| 46-71-071-01 | 1mm 11" 90° upwards cutting | 46-71-073-13 | 5mm 11" 90° downwards |
| 46-71-071-02 | 1mm 12" 90° upwards cutting | 46-71-073-14 | 5mm 12" 90° downwards |
| 46-71-071-03 | 1mm 13" 90° upwards cutting | 46-71-073-15 | 5mm 13" 90° downwards |
| 46-71-071-04 | 2mm 11" 90° upwards cutting | 46-71-073-16 | 6mm 11" 90° downwards |
| 46-71-071-05 | 2mm 12" 90° upwards cutting | 46-71-073-17 | 6mm 12" 90° downwards |
| 46-71-071-06 | 2mm 13" 90° upwards cutting | 46-71-073-18 | 6mm 13" 90° downwards |

FERRIS-SMITH-KERRISON
Bandscheibenstanzen / Intervertebral Disc Rongeurs

| | | | | |
|--------------|-----------------------------|--|--------------|-----------------------------|
| 46-71-069-01 | 1mm 6" 40° upwards cutting | | 46-71-070-10 | 5mm 8° 40° downwards |
| 46-71-069-02 | 1mm 7" 40° upwards cutting | | 46-71-070-11 | 6mm 7° 40° downwards |
| 46-71-069-03 | 1mm 8" 40° upwards cutting | | 46-71-070-12 | 6mm 8° 40° downwards |
| 46-71-069-04 | 1mm 9" 40° upwards cutting | | 46-71-072-01 | 1mm 11" 40° upwards cutting |
| 46-71-069-05 | 1mm 10" 40° upwards cutting | | 46-71-072-02 | 1mm 12" 40° upwards cutting |
| 46-71-069-06 | 2mm 6" 40° upwards cutting | | 46-71-072-03 | 1mm 13" 40° upwards cutting |
| 46-71-069-07 | 2mm 7" 40° upwards cutting | | 46-71-072-04 | 2mm 11" 40° upwards cutting |
| 46-71-069-08 | 2mm 8" 40° upwards cutting | | 46-71-072-05 | 2mm 12" 40° upwards cutting |
| 46-71-069-09 | 2mm 9" 40° upwards cutting | | 46-71-072-06 | 2mm 13" 40° upwards cutting |
| 46-71-069-10 | 2mm 10" 40° upwards cutting | | 46-71-072-07 | 3mm 11" 40° upwards cutting |
| 46-71-069-11 | 3mm 6" 40° upwards cutting | | 46-71-072-08 | 3mm 12" 40° upwards cutting |
| 46-71-069-12 | 3mm 7" 40° upwards cutting | | 46-71-072-09 | 3mm 13" 40° upwards cutting |
| 46-71-069-13 | 3mm 8" 40° upwards cutting | | 46-71-072-10 | 4mm 11" 40° upwards cutting |
| 46-71-069-14 | 3mm 9" 40° upwards cutting | | 46-71-072-11 | 4mm 12" 40° upwards cutting |
| 46-71-069-15 | 3mm 10" 40° upwards cutting | | 46-71-072-12 | 4mm 13" 40° upwards cutting |
| 46-71-069-16 | 4mm 6" 40° upwards cutting | | 46-71-072-13 | 5mm 11" 40° upwards cutting |
| 46-71-069-17 | 4mm 7" 40° upwards cutting | | 46-71-072-14 | 5mm 12" 40° upwards cutting |
| 46-71-069-18 | 4mm 8" 40° upwards cutting | | 46-71-072-15 | 5mm 13" 40° upwards cutting |
| 46-71-069-19 | 4mm 9" 40° upwards cutting | | 46-71-072-16 | 6mm 11" 40° upwards cutting |
| 46-71-069-20 | 4mm 10" 40° upwards cutting | | 46-71-072-17 | 6mm 12" 40° upwards cutting |
| 46-71-069-21 | 5mm 6" 40° upwards cutting | | 46-71-072-18 | 6mm 13" 40° upwards cutting |
| 46-71-069-22 | 5mm 7" 40° upwards cutting | | 46-71-074-01 | 1mm 11" 40° downwards |
| 46-71-069-23 | 5mm 8" 40° upwards cutting | | 46-71-074-02 | 1mm 12" 40° downwards |
| 46-71-069-24 | 5mm 9" 40° upwards cutting | | 46-71-074-03 | 1mm 13" 40° downwards |
| 46-71-069-25 | 5mm 10" 40° upwards cutting | | 46-71-074-04 | 2mm 11" 40° downwards |
| 46-71-069-26 | 6mm 6" 40° upwards cutting | | 46-71-074-05 | 2mm 12" 40° downwards |
| 46-71-069-27 | 6mm 7" 40° upwards cutting | | 46-71-074-06 | 2mm 13" 40° downwards |
| 46-71-069-28 | 6mm 8" 40° upwards cutting | | 46-71-074-07 | 3mm 11" 40° downwards |
| 46-71-069-29 | 6mm 9" 40° upwards cutting | | 46-71-074-08 | 3mm 12" 40° downwards |
| 46-71-069-30 | 6mm 10" 40° upwards cutting | | 46-71-074-09 | 3mm 13" 40° downwards |
| 46-71-070-01 | 1mm 7° 40° downwards | | 46-71-074-10 | 4mm 11" 40° downwards |
| 46-71-070-02 | 1mm 8° 40° downwards | | 46-71-074-11 | 4mm 12" 40° downwards |
| 46-71-070-03 | 2mm 7° 40° downwards | | 46-71-074-12 | 4mm 13" 40° downwards |
| 46-71-070-04 | 2mm 8° 40° downwards | | 46-71-074-13 | 5mm 11" 40° downwards |
| 46-71-070-05 | 3mm 7° 40° downwards | | 46-71-074-14 | 5mm 12" 40° downwards |
| 46-71-070-06 | 3mm 8° 40° downwards | | 46-71-074-15 | 5mm 13" 40° downwards |
| 46-71-070-07 | 4mm 7° 40° downwards | | 46-71-074-16 | 6mm 11" 40° downwards |
| 46-71-070-08 | 4mm 8° 40° downwards | | 46-71-074-17 | 6mm 12" 40° downwards |
| 46-71-070-09 | 5mm 7° 40° downwards | | 46-71-074-18 | 6mm 13" 40° downwards |

| Length of shaft | | | | |
|-----------------|------------|------------|------------|------------|
| 135 mm (5") | 150mm (6") | 180mm (7") | 200mm (8") | 230mm (9") |

PLATTFUSS



Ferris Smith Kerrison With Thin Footplate / mit dünner Fussplatte

| | | | | |
|--------------|----------------------------|--|--------------|----------------------------|
| 46-71-075-01 | 1mm 7° 90° upwards cutting | | 46-71-076-05 | 1mm 7° 40° upwards cutting |
| 46-71-075-02 | 1mm 8° 90° upwards cutting | | 46-71-076-06 | 1mm 8° 40° upwards cutting |
| 46-71-075-03 | 1mm 9° 90° upwards cutting | | 46-71-076-07 | 1mm 9° 40° upwards cutting |
| 46-71-075-04 | 2mm 7° 90° upwards cutting | | 46-71-076-08 | 2mm 7° 40° upwards cutting |
| 46-71-075-05 | 2mm 8° 90° upwards cutting | | 46-71-076-09 | 2mm 8° 40° upwards cutting |
| 46-71-075-06 | 2mm 9° 90° upwards cutting | | 46-71-076-10 | 2mm 8° 40° upwards cutting |
| 46-71-075-07 | 3mm 7° 90° upwards cutting | | 46-71-076-11 | 3mm 7° 40° upwards cutting |
| 46-71-075-08 | 3mm 8° 90° upwards cutting | | 46-71-076-12 | 3mm 8° 40° upwards cutting |
| 46-71-075-09 | 3mm 9° 90° upwards cutting | | 46-71-076-13 | 3mm 9° 40° upwards cutting |
| 46-71-075-10 | 4mm 7° 90° upwards cutting | | 46-71-076-14 | 4mm 7° 40° upwards cutting |
| 46-71-075-11 | 4mm 8° 90° upwards cutting | | 46-71-076-15 | 4mm 7° 40° upwards cutting |
| 46-71-075-12 | 4mm 9° 90° upwards cutting | | 46-71-076-16 | 4mm 8° 40° upwards cutting |
| 46-71-076-01 | 5mm 7° 90° upwards cutting | | 46-71-076-17 | 5mm 7° 40° upwards cutting |
| 46-71-076-02 | 5mm 8° 90° upwards cutting | | 46-71-076-18 | 5mm 8° 40° upwards cutting |
| 46-71-076-03 | 5mm 9° 90° upwards cutting | | 46-71-076-19 | 5mm 9° 40° upwards cutting |
| 46-71-076-04 | 6mm 9° 90° upwards cutting | | 46-71-076-20 | 6mm 9° 40° upwards cutting |

Ferris Smith-Cloward

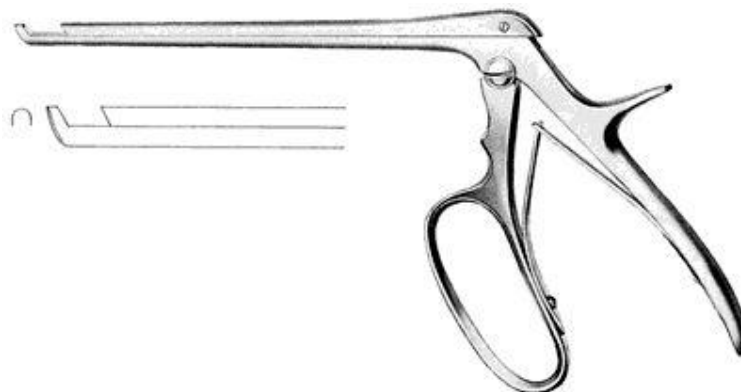

| | | | | |
|--------------|-----------------|--|--------------|-----------------|
| 46-71-078-01 | 2x10mm straight | | 46-71-078-10 | 4x08mm straight |
| 46-71-078-02 | 2x10mm upwards | | 46-71-078-11 | 4x08mm upwards |
| 46-71-078-03 | 2x10mm down | | 46-71-078-12 | 4x08mm down |
| 46-71-078-04 | 3x10mm straight | | 46-71-078-13 | 6x10mm straight |
| 46-71-078-05 | 3x10mm upwards | | 46-71-078-14 | 6x10mm upwards |
| 46-71-078-06 | 3x10mm down | | 46-71-078-15 | 6x10mm down |
| 46-71-078-07 | 4x10mm straight | | 46-71-078-16 | 6x12mm straight |
| 46-71-078-08 | 4x10mm upwards | | 46-71-078-17 | 6x12mm upwards |
| 46-71-078-09 | 4x10mm down | | 46-71-078-18 | 6x12mm down |

Colclough (Richter)



with large handle wide opening / upwards cutting
mit großer Griff / große Öffnung / nach oben schneidend

| | | | | |
|--------------|----------------------------|--|--------------|----------------------------|
| 46-71-077-01 | 2mm 6" 90° upwards cutting | | 46-71-077-16 | 2mm 6" 40° upwards cutting |
| 46-71-077-02 | 2mm 7" 90° upwards cutting | | 46-71-077-17 | 2mm 7" 40° upwards cutting |
| 46-71-077-03 | 2mm 8" 90° upwards cutting | | 46-71-077-18 | 2mm 8" 40° upwards cutting |
| 46-71-077-04 | 3mm 6" 90° upwards cutting | | 46-71-077-19 | 3mm 6" 40° upwards cutting |
| 46-71-077-05 | 3mm 7" 90° upwards cutting | | 46-71-077-20 | 3mm 7" 40° upwards cutting |
| 46-71-077-06 | 3mm 8" 90° upwards cutting | | 46-71-077-21 | 3mm 8" 40° upwards cutting |
| 46-71-077-07 | 4mm 6" 90° upwards cutting | | 46-71-077-22 | 4mm 6" 40° upwards cutting |
| 46-71-077-08 | 4mm 7" 90° upwards cutting | | 46-71-077-23 | 4mm 7" 40° upwards cutting |
| 46-71-077-09 | 4mm 8" 90° upwards cutting | | 46-71-077-24 | 4mm 8" 40° upwards cutting |
| 46-71-077-10 | 5mm 6" 90° upwards cutting | | 46-71-077-25 | 5mm 6" 40° upwards cutting |
| 46-71-077-11 | 5mm 7" 90° upwards cutting | | 46-71-077-26 | 5mm 7" 40° upwards cutting |
| 46-71-077-12 | 5mm 8" 90° upwards cutting | | 46-71-077-27 | 5mm 8" 40° upwards cutting |
| 46-71-077-13 | 6mm 6" 90° upwards cutting | | 46-71-077-28 | 6mm 6" 40° upwards cutting |
| 46-71-077-14 | 6mm 7" 90° upwards cutting | | 46-71-077-29 | 6mm 7" 40° upwards cutting |
| 46-71-077-15 | 6mm 8" 90° upwards cutting | | 46-71-077-30 | 6mm 8" 40° upwards cutting |

Laminektomiestanzen

Laminectomy Punches

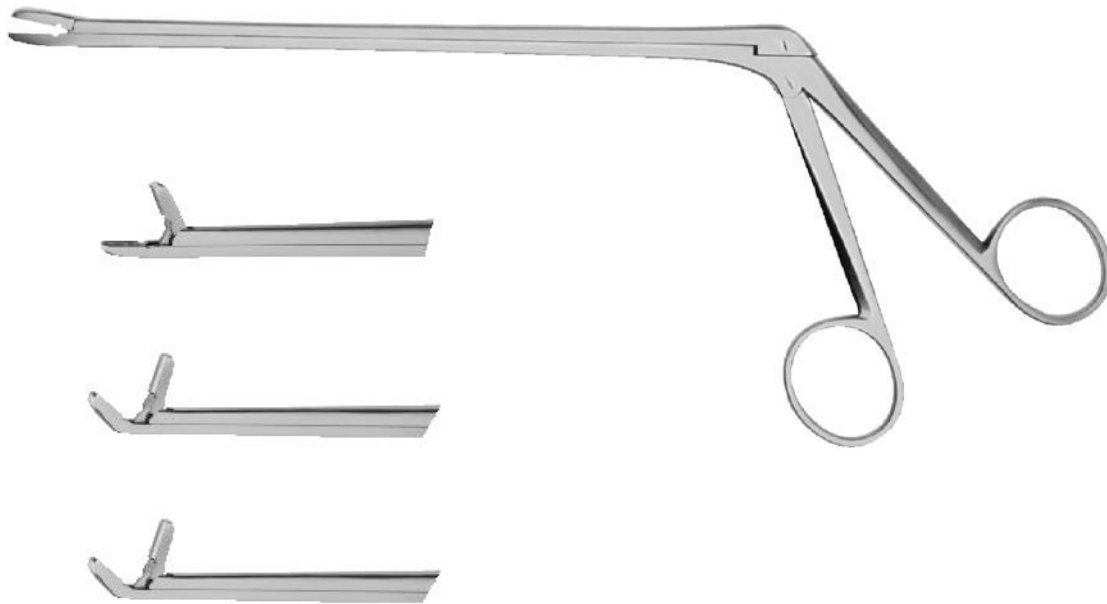

Cushing Rongeur

| | |
|--------------|--------------------|
| 46-71-079-01 | 2x10mm 5" straight |
| 46-71-079-02 | 2x10mm 5" upwards |
| 46-71-079-03 | 2x10mm 5" down |

| | |
|--------------|--------------------|
| 46-71-079-04 | 2x10mm 6" straight |
| 46-71-079-05 | 2x10mm 6" upwards |
| 46-71-079-06 | 2x10mm 6" down |

| | |
|--------------|--------------------|
| 46-71-079-07 | 2x10mm 7" straight |
| 46-71-079-08 | 2x10mm 7" upwards |
| 46-71-079-09 | 2x10mm 7" down |

with large handle / mit grosser Griff

| | |
|--------------|--------------------|
| 46-71-082-01 | 2x10mm 7" straight |
|--------------|--------------------|

| | |
|--------------|-------------------|
| 46-71-082-02 | 2x10mm 7" upwards |
|--------------|-------------------|

| | |
|--------------|----------------|
| 46-71-082-03 | 2x10mm 7" down |
|--------------|----------------|

Love Gruenwald

| | |
|--------------|--------------------|
| 46-71-080-01 | 3x10mm 5" straight |
| 46-71-080-02 | 3x10mm 5" upwards |
| 46-71-080-03 | 3x10mm 5" down |

| | |
|--------------|--------------------|
| 46-71-080-04 | 3x10mm 6" straight |
| 46-71-080-05 | 3x10mm 6" upwards |
| 46-71-080-06 | 3x10mm 6" down |

| | |
|--------------|--------------------|
| 46-71-080-07 | 3x10mm 7" straight |
| 46-71-080-08 | 3x10mm 7" upwards |
| 46-71-080-09 | 3x10mm 7" down |

with large handle / mit grosser Griff

| | |
|--------------|--------------------|
| 46-71-083-01 | 3x10mm 7" straight |
|--------------|--------------------|

| | |
|--------------|-------------------|
| 46-71-083-02 | 3x10mm 7" upwards |
|--------------|-------------------|

| | |
|--------------|----------------|
| 46-71-083-03 | 3x10mm 7" down |
|--------------|----------------|

Spurling

| | |
|--------------|--------------------|
| 46-71-081-01 | 4x10mm 5" straight |
| 46-71-081-02 | 4x10mm 5" upwards |
| 46-71-081-03 | 4x10mm 5" down |

| | |
|--------------|--------------------|
| 46-71-081-04 | 4x10mm 6" straight |
| 46-71-081-05 | 4x10mm 6" upwards |
| 46-71-081-06 | 4x10mm 6" down |

| | |
|--------------|--------------------|
| 46-71-081-07 | 4x10mm 7" straight |
| 46-71-081-08 | 4x10mm 7" upwards |
| 46-71-081-09 | 4x10mm 7" down |

with large handle / mit grosser Griff

| | |
|--------------|--------------------|
| 46-71-084-01 | 4x10mm 7" straight |
|--------------|--------------------|

| | |
|--------------|-------------------|
| 46-71-084-02 | 4x10mm 7" upwards |
|--------------|-------------------|

| | |
|--------------|----------------|
| 46-71-084-03 | 4x10mm 7" down |
|--------------|----------------|

Sterilisation
Sterilization
Stérilisation
Esterilización
Щипцы стерилизационные





DAVIS
16,0 cm, 6³/₄" **29-76-160-16**
20,0 cm, 8" **29-76-160-20**
24,0 cm, 9¹/₂" **29-76-160-24**



CHEATTLE
27,0 cm, 10⁵/₈"
29-76-163-27



ROGGE
23,0 cm, 9"
29-76-164-23



PYE-SMITH (HARRISON)
30,0 cm, 12"
29-76-166-30



MAYO
14,0 cm, 5¹/₂"
29-76-151-14



BUNT
12,0 cm, 4³/₄"
29-76-154-12



| | |
|----------------|---------------------|
| Ø 30 x 60 mm | 29-76-142-01 |
| Ø 50 x 100 mm | 29-76-142-02 |
| Ø 50 x 130 mm | 29-76-142-03 |
| Ø 50 x 175 mm | 29-76-142-04 |
| Ø 75 x 100 mm | 29-76-142-05 |
| Ø 175 x 130 mm | 29-76-142-06 |
| Ø 175 x 175 mm | 29-76-142-07 |
| Ø 100 x 175 mm | 29-76-142-08 |
| Ø 100 x 200 mm | 29-76-142-09 |



| | |
|------------|---------------------|
| Ø 40,0 mm | 29-76-130-04 |
| Ø 60,0 mm | 29-76-130-06 |
| Ø 80,0 mm | 29-76-130-08 |
| Ø 100,0 mm | 29-76-130-10 |
| Ø 120,0 mm | 29-76-130-12 |
| Ø 150,0 mm | 29-76-130-15 |



| | |
|--------|---------------------|
| 170 mm | 29-76-140-17 |
| 200 mm | 29-76-140-20 |
| 250 mm | 29-76-140-25 |
| 275 mm | 29-76-140-27 |



| | |
|-------------|---------------------|
| 165 x 60 mm | 29-76-133-00 |
| 175 x 70 mm | 29-76-133-10 |
| 220 x 80 mm | 29-76-133-20 |
| 225 x 90 mm | 29-76-133-30 |
| 240 x110 mm | 29-76-133-40 |
| 255 x115 mm | 29-76-133-50 |
| 275 x115 mm | 29-76-133-60 |
| 290 x125 mm | 29-76-133-70 |
| 310 x120 mm | 29-76-133-80 |
| 345 x125 mm | 29-76-133-90 |
| 380 x130 mm | 29-76-133-13 |
| 415 x140 mm | 29-76-133-14 |

Schalen
Trays
Plateaux universaux
Bandejas
Лотки, подносы



| | |
|--------------------|---------------------|
| 165 x 85 x 35 mm | 29-76-200-01 |
| 200 x 100 x 35 mm | 29-76-200-02 |
| 200 x 100 x 50 mm | 29-76-200-03 |
| 230 x 130 x 50 mm | 29-76-200-04 |
| 260 x 150 x 50 mm | 29-76-200-05 |
| 270 x 235 x 50 mm | 29-76-200-06 |
| 300 x 200 x 50 mm | 29-76-200-07 |
| 325 x 275 x 50 mm | 29-76-200-08 |
| 350 x 250 x 150 mm | 29-76-200-09 |
| 420 x 130 x 100 mm | 29-76-200-10 |
| 430 x 200 x 120 mm | 29-76-200-20 |
| 450 x 190 x 80 mm | 29-76-200-19 |



50 ccm
29-76-310-50



25 ccm
29-76-310-25



29-76-300-01
Ø 62 x 13 mm

Innendose allein
Interior box only
boite seul
Caja interior, suelta
Только внутренняя коробка

29-76-300-00
Ø 65 x 17 mm

Außen- und Innendose
Exterior and interior box
extérieur et intérieur boîte
Caja exterior e interior
Внешняя и внутренняя коробки



ПТТ МЕДТЕХНИКА

**TONOMETER
TONOMETER
LE TONOMETRE
EL TONOMETRO
ТОНОМЕТР**

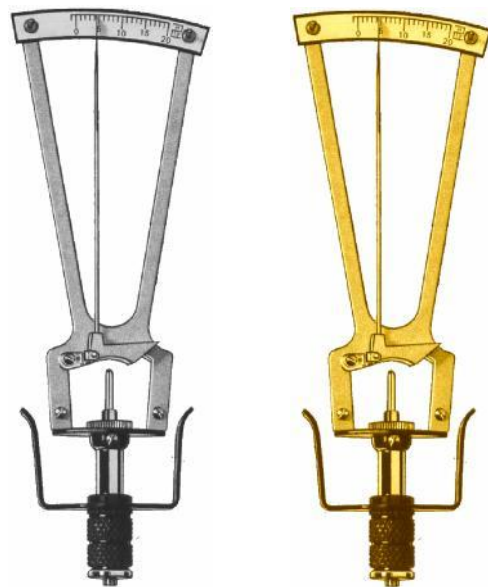



Schioetz –TONOMETER
31-10-001-00

- komplett mit 3 Gewichten (5,5 g, 7,5 g und 10 g) in gerader oder 45° gebogener Skalenanordnung
- complete with set of 3 weight units (5.5, 7.5 and 10 grams). Available with either straight scale layout or scale curved to an angle of 45
- complet avec 3 poids (5,5 g, 7,5 g et 10 g), avec un cadre droit ou orient à 45 V.
- completo con 3 pesas (de 5,5gr, 7,5 gr y 10 gramos), con cuadro de escala recto o bien inclinado a 45
- в комплекте с 3-я весами (5,5 г., 7,5 г. и 10 г) с прямой и под 45° наклоненной шкалой

1. Eloxierter Skalenträger / anodized scale mount / Porte-cadran anodis / Portaescala anodizado / элксирующий держатель шкалы
2. Zeiger und Hebel / pointer and lever / Aiguille et levier / Aguja y palanca / стрелка и ручка
3. Fingerbügel und Querträger / finger rest and transversal support / Bride et support transversal / Ароуа-dedo y soporte transversal / пальчиковое коромысло и поперечный держатель
4. 10 g, 7,5 g und 5,5 g - Gewichte / 10 gram, 7.5 gram and 5.5 gram weight units / 4) Poids de 10, 7,5 g et 5,5 g / Pesas de 10 gramos, 7,5 gramos / 10 г, 7,5 г. 5,5 г веса

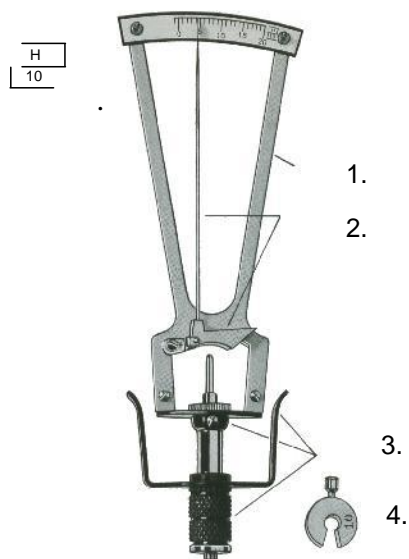

technische Änderungen vorbehalten
Subject to any technical improve efficiency
технические изменения допускаются

**Stimmgabeln für Ohrenärzte
Tuning Forks for Aurists
Diapasons pour auristes
Diapasones para otologos
Камертон для ЛОР врачей**



Stimmgabeln für Ohrenärzte mit Dämpfer
 Tuning Forks for Aurists with clamps
 Diapasons pour auristes avec curseurs
 Diapasones para otologos con sordinas
 Камертон для ЛОР врачей с глушителем

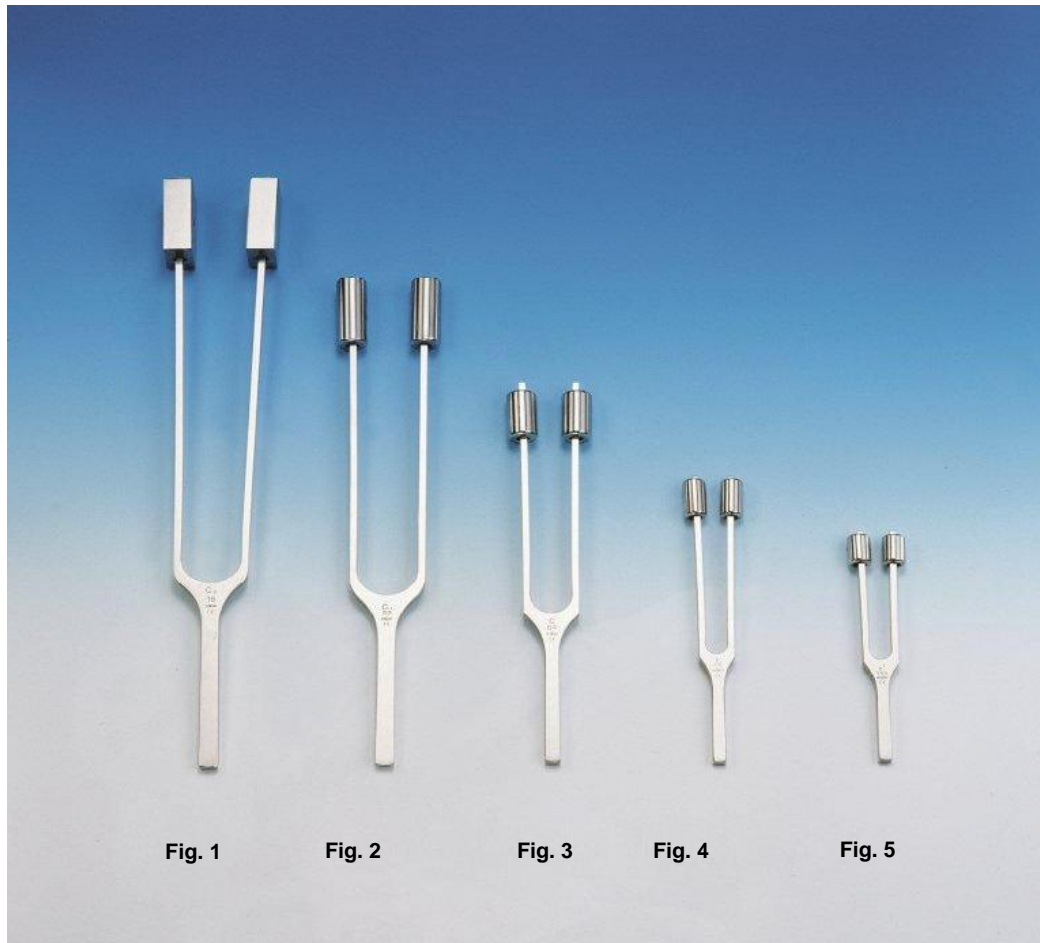

- | | | | | |
|---------------|----------------------|-------------------|--------|------------|
| Fig. 1 | 33-10-001-016 | = C ₂ | 16 Hz | (French) |
| Fig. 2 | 33-10-002-032 | = C ₋₁ | 32 Hz | (French) |
| Fig. 3 | 33-10-003-064 | = C | 64 Hz | (Hartmann) |
| Fig. 4 | 33-10-004-128 | = c | 128 Hz | (Hartmann) |
| Fig. 5 | 33-10-005-256 | = c ¹ | 256 Hz | (Hartmann) |

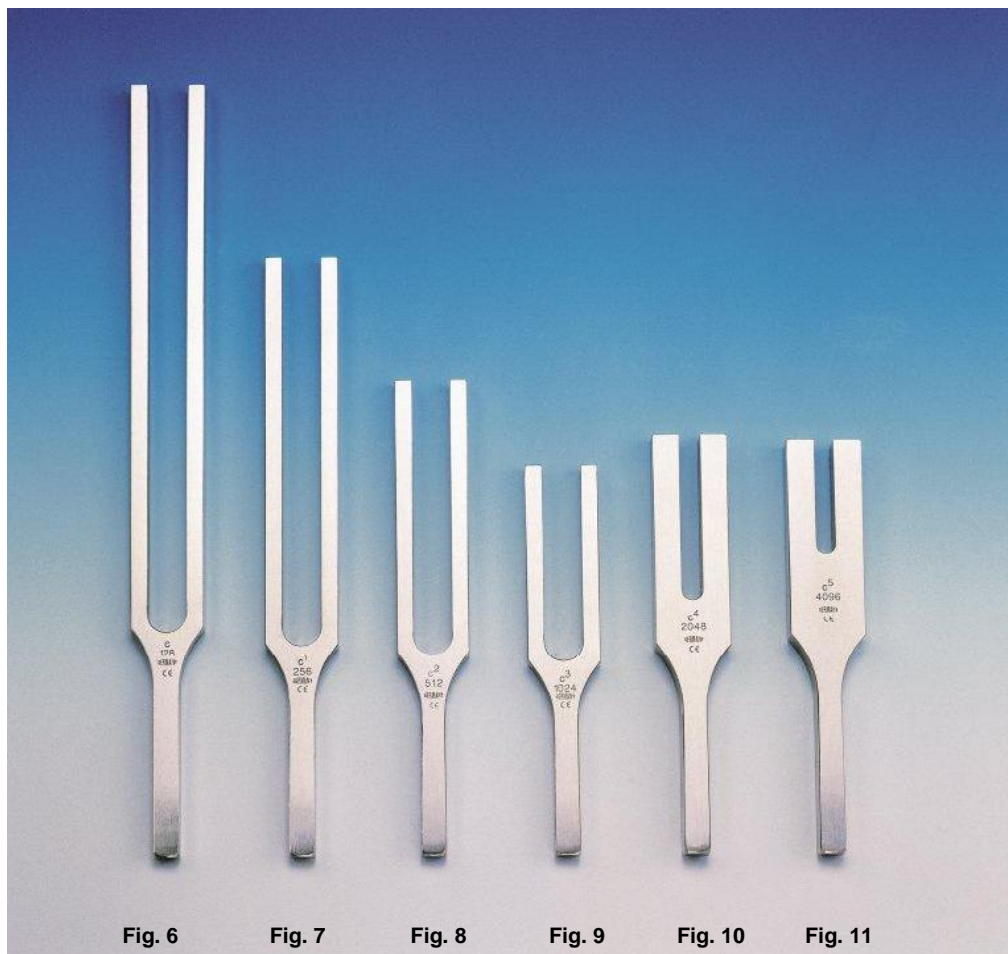

| | | | |
|----------------|-----------------------|-----------------|--------------------|
| Fig. 6 | 33-10-006-128 | =c | 128 Hz (Hartmann) |
| Fig. 7 | 33-10-007-256 | =c ¹ | 256 Hz (Hartmann) |
| Fig. 8 | 33-10-008-512 | =c ² | 512 Hz (Hartmann) |
| Fig. 9 | 33-10-009-1024 | =c ³ | 1024 Hz (Hartmann) |
| Fig. 10 | 33-10-010-2048 | =c ⁴ | 2048 Hz (Hartmann) |
| Fig. 11 | 33-10-011-4096 | =c ⁵ | 4096 Hz (Hartmann) |

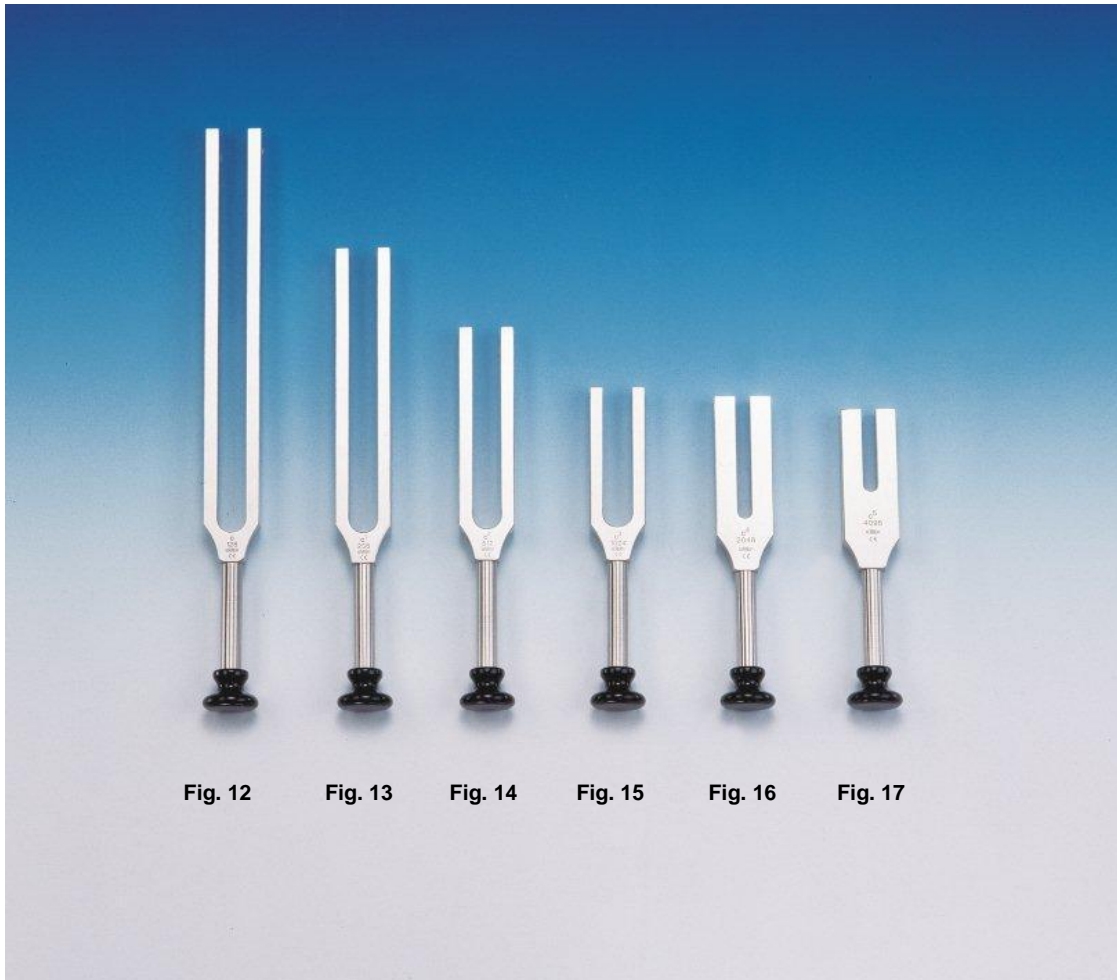

Fig. 12

Fig. 13

Fig. 14

Fig. 15

Fig. 16

Fig. 17

| | | | |
|----------------|-----------------------|------------------|-----------------|
| Fig. 12 | 33-10-012- 128 | =c | 128 Hz (Lucae) |
| Fig. 13 | 33-10-013- 256 | = c ¹ | 256 Hz (Lucae) |
| Fig. 14 | 33-10-014- 512 | =c ² | 512 Hz (Lucae) |
| Fig. 15 | 33-10-015-1024 | =c ³ | 1024 Hz (Lucae) |
| Fig. 16 | 33-10-016-2048 | =c ⁴ | 2048 Hz (Lucae) |
| Fig. 17 | 33-10-017-4096 | =c ⁵ | 4096 Hz (Lucae) |

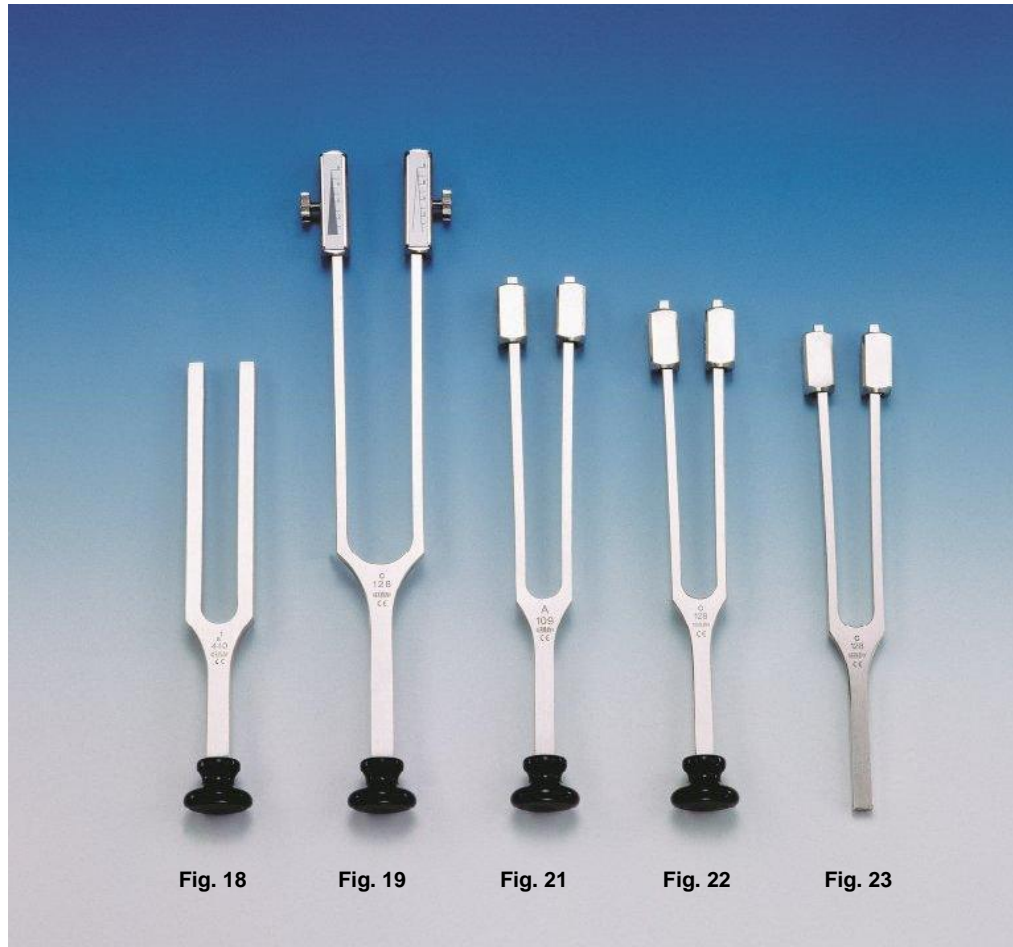

- | | | | |
|----------------|-----------------------|------------------|--|
| Fig. 18 | 33-10-018- 440 | = a | 440 Hz mit Fuß |
| Fig. 19 | 33-10-019- 64 | = C | 64 Hz / c 128 Hz, Dämpfer abnehmbar, mit Fuß, (Rydel-Seiffer) |
| Fig. 20 | 33-10-020- 109 | = A | 109 Hz verstellbar bis g 194 Hz, ohne Fuß (keine Abbildung) |
| Fig. 21 | 33-10-021- 109 | = A | 109 Hz verstellbar bis g 194 Hz, mit Fuß, (König) |
| Fig. 22 | 33-10-022- 128 | = c | 128 Hz verstellbar bis h 240 Hz, mit Fuß, (Lucae) |
| Fig. 23 | 33-10-023- 128 | = c | 128 Hz verstellbar bis h 240 Hz, ohne Fuß |
| | | | |
| Fig. 18 | 33-10-018- 440 | = a ¹ | 440 Hz wit foot |
| Fig. 19 | 33-10-019- 64 | = C | 64 Hz / c 128 Hz detachable clamps, with foot (Rydel-Seiffer) |
| Fig. 20 | 33-10-020- 109 | = A | 109 Hz adjustable up to g 194 Hz. without foot (not illustrated) |
| Fig. 21 | 33-10-021- 109 | = A | 109 Hz adjustable up to g 194 Hz. with foot (König) |
| Fig. 22 | 33-10-022- 128 | = c | 128 Hz adjustable up to h 240 Hz with foot (Lucae) |
| Fig. 23 | 33-10-023- 128 | = c | 128 Hz adjustable up to h 240 Hz without foot |

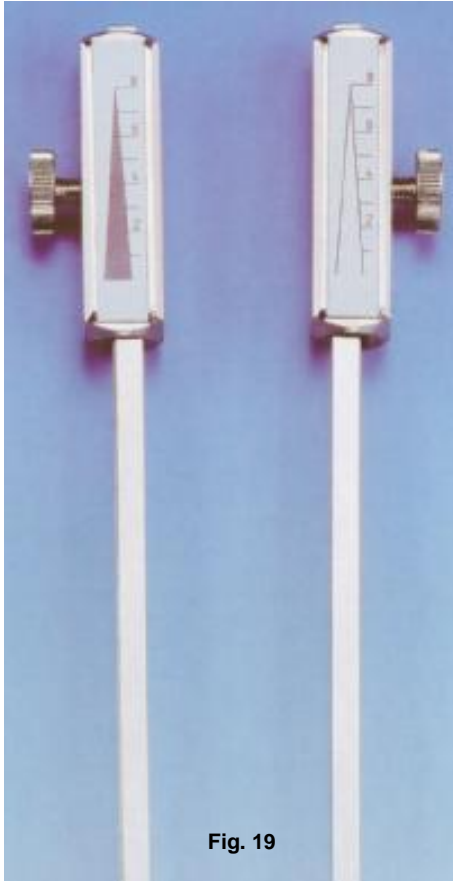

Fig. 19



Fig. 20/21



Fig. 22/23

- | | | | |
|---------|----------------|------------------|---|
| Fig. 18 | 33-10-018- 440 | = a ¹ | 440 Hz avec pied |
| Fig. 19 | 33-10-019- 64 | = C | 64 Hz / c 128 Hz, curseurs detachables, avec pied, (Rydel-Seiffer) |
| Fig. 20 | 33-10-020- 109 | = A | 109 Hz réglable jusqu'à g 194 Hz, sans pied (pas illustre) |
| Fig. 21 | 33-10-021- 109 | = A | 109 Hz réglable jusqu'à g 194 Hz, avec pied (König) |
| Fig. 22 | 33-10-022- 128 | = c | 128 Hz réglable jusqu'à h 240 Hz, avec pied, (Lucae) |
| Fig. 23 | 33-10-023- 128 | = c | 128 Hz réglable jusqu'à h 240 Hz, sans pied |
| | | | |
| Fig. 18 | 33-10-018- 440 | = a ¹ | 440 Hz con pie |
| Fig. 19 | 33-10-019- 64 | = C | 64 Hz / c 128 Hz, sordinas demontables, con pie, (Rydel-Seiffer) |
| Fig. 20 | 33-10-020- 109 | = A | 109 Hz graduable hasta g 194 Hz, sin pie (no ilustrado) |
| Fig. 21 | 33-10-021- 109 | = A | 109 Hz graduable hasta g 194 Hz, con pie (König) |
| Fig. 22 | 33-10-022- 128 | = c | 128 Hz graduable hasta g 240 Hz, con pie, (Lucae) |
| Fig. 23 | 33-10-023- 128 | = c | 128 Hz graduable hasta g 240 Hz, sin pie, |
| | | | |
| Fig. 18 | 33-10-018- 440 | = a ¹ | 440 Hz на ножке |
| Fig. 19 | 33-10-019- 64 | = C | 64 Hz / c 128 Hz со снимаемым глушителем на ножке (Rydel-Seiffer) |
| Fig. 20 | 33-10-020- 109 | = A | 109 Hz выставяемого до g 194 Hz, без ножки (без картинки) |
| Fig. 21 | 33-10-021- 109 | = A | 109 Hz выставяемого до g 194 Hz, с ножкой (König) |
| Fig. 22 | 33-10-022- 128 | = c | 128 Hz выставяемого до h 240 Hz, с ножкой, (Lucae) |
| Fig. 23 | 33-10-023- 128 | = c | 128 Hz выставяемого до h 240 Hz, без ножки |



Fig. 24



Fig. 25

Stimmgabelbesteck für Ohrenärzte (im Samtetui / Kunstleder bezogen)
 Sets of Tuning Forks for Aurists (in velvet-lined case / imitation leather referred)
 Jeux de diapasons pour auristes (en boîte garnie de velours / les similis-cuir ont renvoye)
 Juegos de Diapasones para otologos (en estuche forrado de terciopelo / pieles artificiales referidas)
 Камертон, набор для ЛОР врачей (на бархате / в футляре, обтянутом кожей)

Fig. 24 33-10-024-00

Erweitertes Besteck nach Hartmann (c 128Hz/ c¹ 256 Hz/ c³ 1024 Hz/ c⁴ 2048 Hz/ c⁵ 4096 Hz)
Augmented set of tuning forks, pattern Hartmann (c 128Hz/ c¹ 256 Hz/ c³ 1024 Hz/ c⁴ 2048 Hz/ c⁵ 4096 Hz)
Eu augmente de diapasons selon Hartmann (c 128Hz/ c¹ 256 Hz/ c³ 1024 Hz/ c⁴ 2048 Hz/ c⁵ 4096 Hz)
Juego mas completo de diapasones, segun Hartmann (c 128Hz/ c¹ 256 Hz/ c³ 1024 Hz/ c⁴ 2048 Hz/ c⁵ 4096 Hz)
Расширенный набор по Hartmann (c 128Hz/ c¹ 256 Hz/ c³ 1024 Hz/ c⁴ 2048 Hz/ c⁵ 4096 Hz)

Fig. 25 33-10-025-00

Stimmgabelbesteck nach Hartmann (c 128Hz/ c¹ 256 Hz/ c³ 1024 Hz/ c⁴ 2048 Hz)
Set of tuning forks pattern Hartmann (c 128Hz/ c¹ 256 Hz/ c³ 1024 Hz/ c⁴ 2048 Hz)
Jeu de diapasons selon Hartmann (c 128Hz/ c¹ 256 Hz/ c³ 1024 Hz/ c⁴ 2048 Hz)
Juego de diapasones segun Hartmann (c 128Hz/ c¹ 256 Hz/ c³ 1024 Hz/ c⁴ 2048 Hz)
Набор камертоновых вилок по Hartmann (c 128Hz/ c¹ 256 Hz/ c³ 1024 Hz/ c⁴ 2048 Hz)

Stimmgabelbesteck für Ohrenärzte
Sets of Tuning Forks for Aurists
Jeux de diapasons pour auristes
Juegos de Diapasones para otologos
Камертон, набор для ЛОР врачей

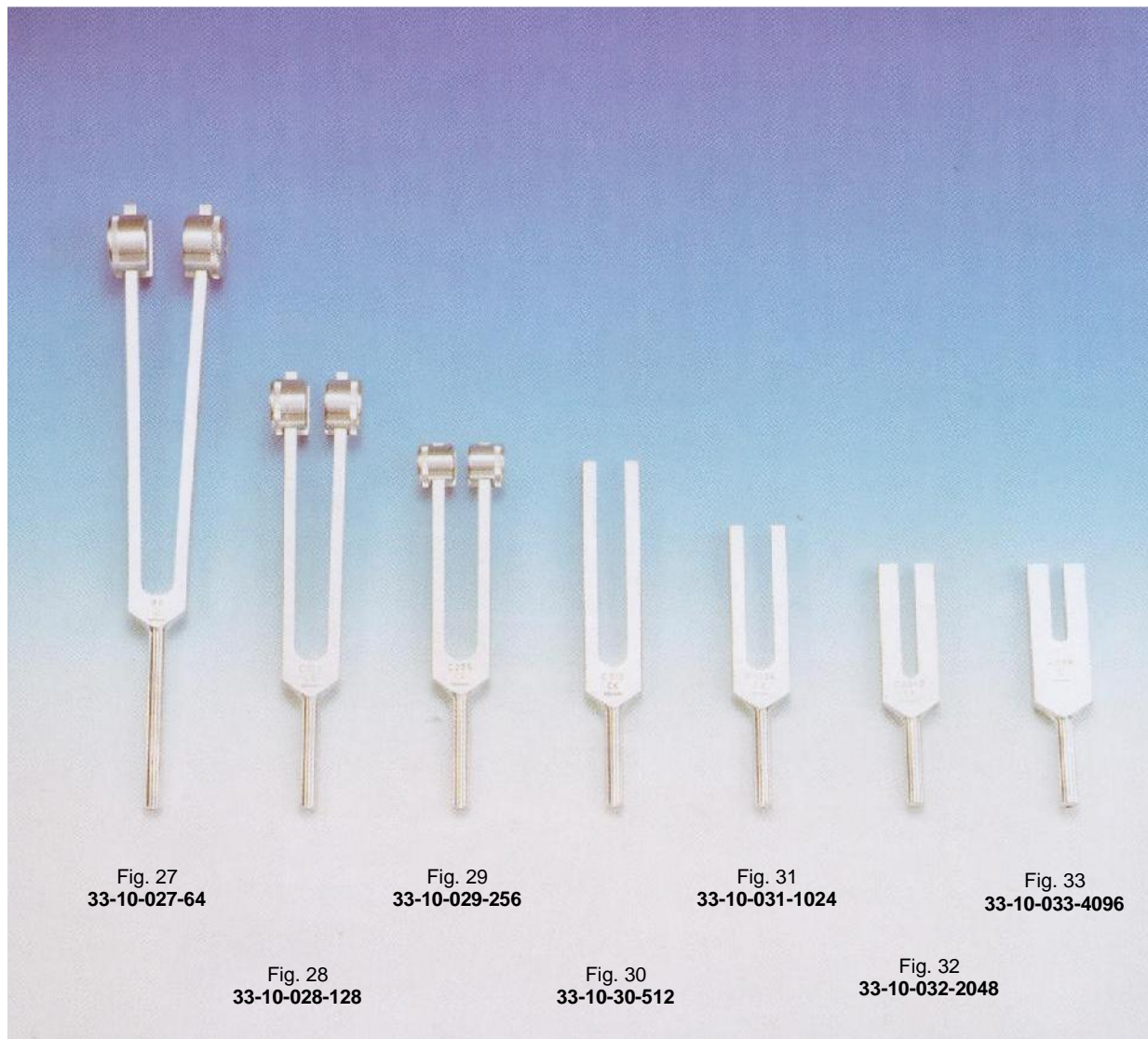

Fig. 26

Stimmgabelbesteck für Ohrenärzte (im Samteteui / Leder bezogen)
Sets of Tuning Forks for Aurists (in velvet-lined case / imitation leather referred)
Jeux de diapasons pour auristes (en boîte garnie de velours / les similis-cuir ont renvoye)
Juegos de Diapasones para otologos (en estuche forrado de terciopelo / pieles artificiales referidas)
Камертон, набор для ЛОР врачей (на бархате/ в футляре, обтянутом кожей)

Fig. 26 33-10-026-00

Großes Besteck nach Hartman-Ostmann (C₋₁ 32 Hz/ C 64 Hz/c 128Hz/ c¹ 256 Hz/ c³ 1024 Hz/ c⁴ 2048 Hz/ c⁵ 4096 Hz)
Large set, pattern Hartmann-Ostmann (C₋₁ 32 Hz/ C 64 Hz/c 128Hz/ c¹ 256 Hz/ c³ 1024 Hz/ c⁴ 2048 Hz/ c⁵ 4096 Hz)
Jeu grand selon Hartman-Ostmann (C₋₁ 32 Hz/ C 64 Hz/c 128Hz/ c¹ 256 Hz/ c³ 1024 Hz/ c⁴ 2048 Hz/ c⁵ 4096 Hz)
Juego grande, segun Hartmann-Osmann (C₋₁ 32 Hz/ C 64 Hz/c 128Hz/ c¹ 256 Hz/ c³ 1024 Hz/ c⁴ 2048 Hz/ c⁵ 4096 Hz)
Большой набор по Hartmann-Osmann (C₋₁ 32 Hz/ C 64 Hz/c 128Hz/ c¹ 256 Hz/ c³ 1024 Hz/ c⁴ 2048 Hz/ c⁵ 4096 Hz)



Stimmgabeln aus Aluminium-Legierung für medizinische Zwecke, z.B. für Gehörprüfungen (Luft- und Knochenleitungen, für Sensibilitätsprüfungen und andere diagnostischen Zwecke (C 64 Hz/c 128Hz/ c¹ 256 Hz/ c³ 1024 Hz/ c⁴ 2048 Hz/ c⁵ 4096 Hz)

Touning forks made from aluminium-alloy, for medical purposes, such as examination of hearing (air and bone conduction), for sensibility examinations, and other diagnostic purposes (C 64 Hz/c 128Hz/ c¹ 256 Hz/ c³ 1024 Hz/ c⁴ 2048 Hz/ c⁵ 4096 Hz)

Diapasons d'un alliage aluminium, concus specifiquement pour fins de Diagnostiques medicaux (C 64 Hz/c 128Hz/ c¹ 256 Hz/ c³ 1024 Hz/ c⁴ 2048 Hz/ c⁵ 4096 Hz)

Diapason de aleacion al aluminio, destinado a fines medicos por ejemplo, determinacion de agudeza auditiv-sensibilidad (de transmision en cuanto al aire y las piezas oseas, en diagnosticos sobre sensibilitad y de otras Indoles (C 64 Hz/c 128Hz/ c¹ 256 Hz/ c³ 1024 Hz/ c⁴ 2048 Hz/ c⁵ 4096 Hz)

Камертон из алюминиевого сплава, предназначен для медицинских целей, например, для проверки слуха (проводимость по воздуху, чувствительность и для других диагностических целей) (C 64 Hz/c 128Hz/ c¹ 256 Hz/ c³ 1024 Hz/ c⁴ 2048 Hz/ c⁵ 4096 Hz)

Satz von 5 Aluminium-Legierung Stimmgabeln, im Etui
 Set of 5 aluminium-alloy tuning forks, in a case
 Jeu de 5 diapasons, alliage aluminium, dans un etui
 Juego especial integrado por 5 diapasones en acero al aluminio, en estuche
 Набор из 5 алюминиевых камертоновых вилок, в футляре



Fig. 34
 33-10-034-00

33

Fig. 34 Satz von 5 Aluminium-Legierung Stimmgabeln, in Etui
 Set of 5 aluminium-alloy tuning forks, in a case
 Jeu de 5 diapasons, alliage aluminium, dans un etui
 Juego especial integrado por 5 diapasones en acero al aluminio, en estuche
 Набор из 5 камертонов из алюминиевого сплава (в футляре)

Fig. 28 - Fig. 32 (с 128Hz/ с¹ 256 Hz/ с³ 1024 Hz/ с⁴ 2048 Hz/ с⁵ 4096 Hz)

Neurologische Kombinations-Stimmgabel „NEUROTONE – 5“ (mit Etui)
 Neurological Multi-Function Tuning Fork „NEUROTONE – 5“ (in a case)
 Neurologique diapason combinaison „NEOROTONE – 5“ (dans un etui)
 Diapason combinado para neurologia „NEOROTONE – 5“ (en estuche)
 Неврологический комбинированный камертон «NEUROTONE – 5» (в футляре)



Fig. 35

Fig. 35 33-10-035-00

In dieser Stimmgabel wurden 5 verschiedene Instrumente für umfassende neurologische Diagnosen vereint:

Stimmgabel für Gehör- und Vibrationstest (Luft- und Knochenleitung)
 Der Perkussions-Hammer zum Test der Sehnenreflexe
 Das Nadelrad (Wartenberg-Rad) zur Prüfung der Schmerzempfindlichkeit
 Die Nadel zum Test verschiedener Hautreflexe
 Der Pinsel für Prüfungen der Haut- und Oberflächensensibilität

This universal neurological tuning fork combines 5 different separate diagnostic instruments:

The tuning fork for audio testing and vibration sensation (air and bone conduction)
 The percussion hammer for testing sinew reflexes
 The pin wheel (Wartenberg) for testing pain sensibility
 The needle for testing different reflexes of the skin
 The brush for different tests of the skin and surface sensibility

En este diapason fueron reunidos 5 instrumentos diferentes para extensos diagnosticos neurologicos:

El diapason para el conducto auditivo y prueba de de vibration (aire y conducto de huesos)
 El martillo de percusion para prueba de reflejo de los tendons
 La rueda de agujas (Wartenberg-Rad) para exsaminar la sensibilidad de dolores
 La aguja para examinar los diferentes reflejos de la piel
 El pincel para examinar la sensibilidad de la superficie cutanea

Этот комбинированный камертон соединяет в себе 5 различных инструментов диагностирования:

Камертон для проверки слуха и вибрационного теста
 Перкусионный молоточек для проверки рефлексов сухожилий
 Игла (Wartenberg-Rad) для проверки чувствительности на боль
 Игла для проверки чувствительности кожи
 Кисточка для проверки поверхности кожи на сенсibilitет

NG-Stimmgabeln aus Aluminium Legierung
NG-Tuning forks made from alluminum-alloy
Ng- Diapasons d'un alliage aluminium
NG- Diapason de aleacion al aluminio
NG-камертон алюминированный

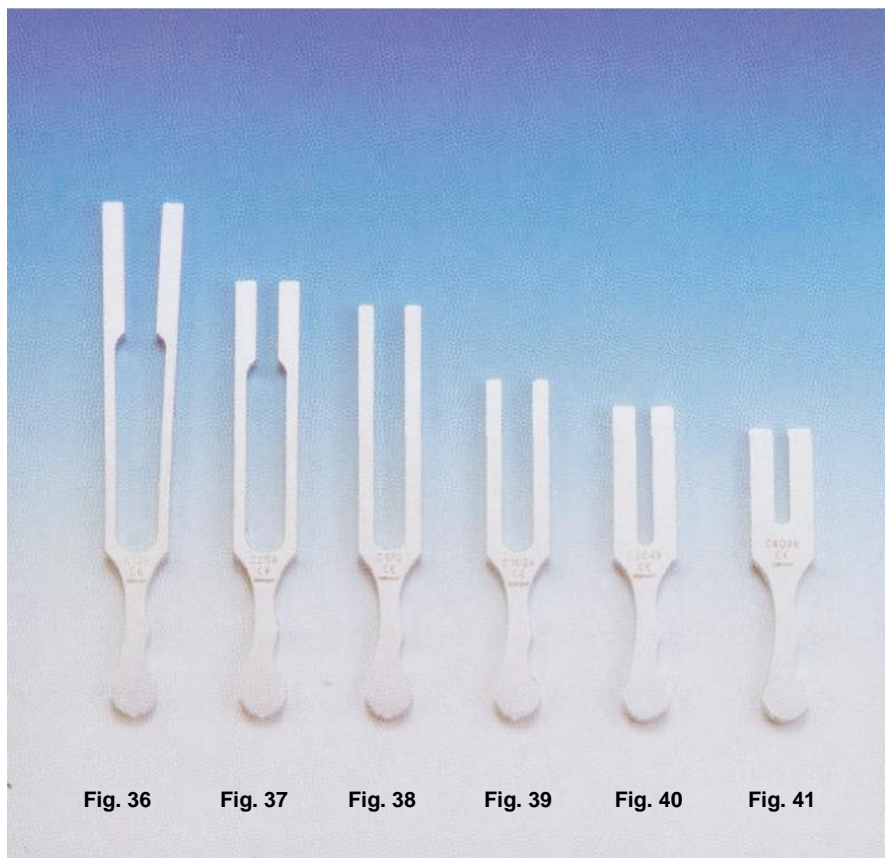

Fig. 36 33-10-036-00
Fig. 37 33-10-037-00
Fig. 38 33-10-038-00
Fig. 39 33-10-039-00
Fig. 40 33-10-040-00
Fig. 41 33-10-041-00

NG-Stimmgabeln aus Aluminium-Legierung für medizinische Zwecke, z.B. für Gehörprüfungen ähnlich Fig. 36 bis 41, Griff ergonomisch, Gewichte integriert (c 128Hz/ c¹ 256 Hz/ c³ 1024 Hz/ c⁴ 2048 Hz/ c⁵ 4096 Hz)

NG-Tuning forks made from alluminum-alloy, for medical purposes, simiarly Fig 36 - Fig.41, ergonomic grasp, integrated weights (c 128Hz/ c¹ 256 Hz/ c³ 1024 Hz/ c⁴ 2048 Hz/ c⁵ 4096 Hz)

Ng-Diapasons d'un alliage aluminium, concus specifiquement pour fins de Diagnostiques medicaux, de facon semblable Fig. 36 - Fig. 41, prise ergonomique, poids integers (c 128Hz/ c¹ 256 Hz/ c³ 1024 Hz/ c⁴ 2048 Hz/ c⁵ 4096 Hz)

NG-Diapason de aleacion al aluminio, destinado a fines medicos por ejemplo, determination de agudeza auditiv-sensibilidad semejantemente Fig. 36 - Fig 41, asimiento ergonomico, pesos integrados (c 128Hz/ c¹ 256 Hz/ c³ 1024 Hz/ c⁴ 2048 Hz/ c⁵ 4096 Hz)

NG-камертон алюминированный медицинского назначения, например, для проверки слуха, подобный Fig. 36 - Fig. 41, ручка эргономической формы, с интегрированными грузиками (c 128Hz/ c¹ 256 Hz/ c³ 1024 Hz/ c⁴ 2048 Hz/ c⁵ 4096 Hz)

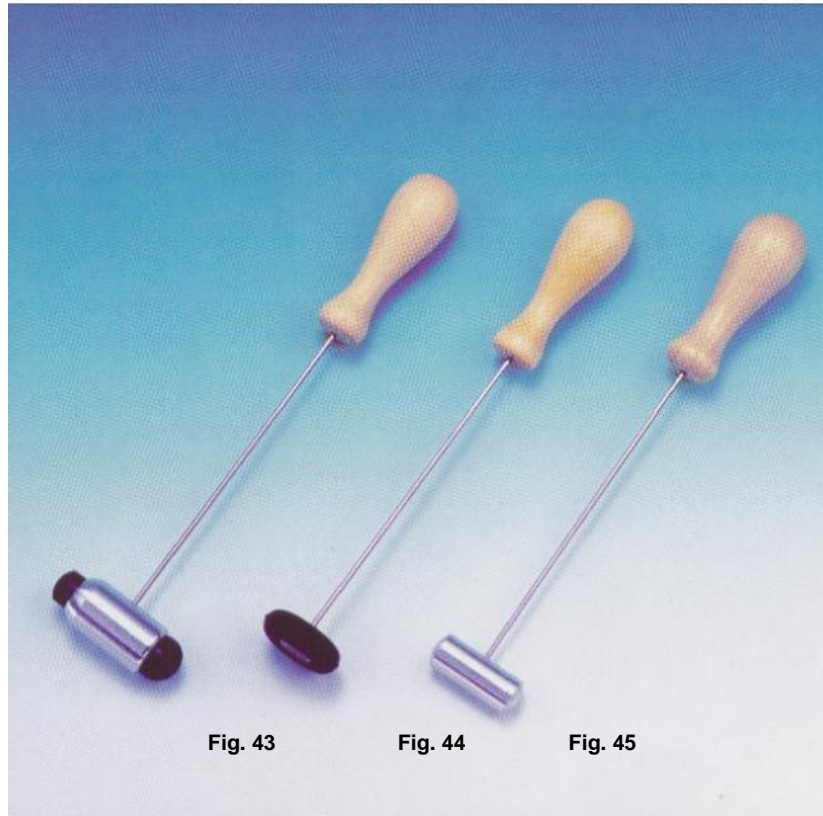

Fig. 43 33-10-044-00

Anschlaghammer für Stimmgabeln der Tone c^3 1024 Hz / c^4 2048 Hz / c^5 4096 Hz
Touching hammer for Tuning Forks of tones c^3 1024 Hz / c^4 2048 Hz / c^5 4096 Hz
Marteau a toucher les diapasons des sons c^3 1024 Hz / c^4 2048 Hz / c^5 4096 Hz
Martillo de tocar para los diapasones de tonos c^3 1024 Hz / c^4 2048 Hz / c^5 4096 Hz
Ударный молоточек для камертона тонов c^3 1024 Hz / c^4 2048 Hz / c^5 4096 Hz

Fig. 44 33-10-045-00

Anschlaghammer für Stimmgabeln der Tone c 128 Hz / c^1 256 Hz / c^3 1024 Hz / c^4 2048 Hz / c^5 4096 Hz,
 mit zwei verschiedenen harten Einsätzen
Touching hammer for Tuning Forks of tones c 128 Hz / c^1 256 Hz / c^3 1024 Hz / c^4 2048 Hz / c^5 4096 Hz
 with two different touching-surfaces
Marteau a toucher les diapasons des sons c 128 Hz / c^1 256 Hz / c^3 1024 Hz / c^4 2048 Hz / c^5 4096 Hz
 avec deux autres mise dures
Martillo de tocar para los diapasones de tonos c 128 Hz / c^1 256 Hz / c^3 1024 Hz / c^4 2048 Hz /
 c^5 4096 Hz con dos diferente durus insertadaes
Ударный молоточек для камертона тонов c 128 Hz / c^1 256 Hz / c^3 1024 Hz / c^4 2048 Hz / c^5 4096 Hz
 с двумя различными по твердости насадками

Fig. 45 33-10-045-00

Anschlaghammer für Stimmgabeln der Tone c 128 Hz bis c^3 1024 Hz
Touching hammer for Tuning Forks of tones c 128 Hz to c^3 1024 Hz
Marteau a toucher les diapasons des sons c 128 Hz jusqu'a c^3 1024 Hz
Martillo de tocar para los diapasones de tonos c 128 Hz hasta c^3 1024 Hz
Ударный молоточек для камертона тонов c 128 Hz до c^3 1024 Hz

Durchschneidende Blakesley Zange
Thru bite Blakesley forceps

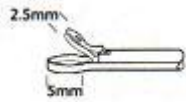

37-23-072-60 Durchneidende Blakesley Zange, Größe 2,5 x 5 mm, gerade
 Thru Bite Blakesley forceps, size 2,5 x 5 mm, Pediatric, straight



37-23-072-80 Durchneidende Blakesley Zange, Größe 3,6 x 8 mm, gerade
 Thru Bite Blakesley forceps, size 3,6 x 8 mm, straight



37-23-073-00 Durchneidende Blakesley Zange, Größe 4,8 x 14 mm, gerade
 Thru Bite Blakesley forceps, size 4,8 x 14 mm, straight



37-23-072-70 Durchneidende Blakesley Zange, Größe 2,5 x 5,5 mm, 45° gewinkelt
 Thru Bite Blakesley forceps, size 2,5 x 5,5 mm, 45°, Pediatric, angled

Thru Bite Blakesley forceps, size 2,5 x 5,5 mm, 45°, Pediatric, angled

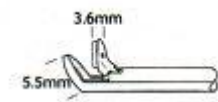

37-23-072-90 Durchneidende Blakesley Zange, Größe 3,6 x 5,5 mm, 45° gewinkelt
 Thru Bite Blakesley forceps, size 3,6 x 5,5 mm, 45°, angled



37-23-073-10 Durchneidende Blakesley Zange, Größe 4,8 x 13,0 mm, 45° gewinkelt
 Thru Bite Blakesley forceps, size 4,8 x 13,0 mm, 45°, angled



37-23-074-30 Durchneidende Blakesley Zange, Größe 3,6 x 6,5 mm, links
 Thru Bite Blakesley forceps, size 3,6 x 6,5 mm, curved left



37-23-074-20 Durchneidende Blakesley Zange, Größe 3,6 x 6,5 mm, rechts
 Thru Bite Blakesley forceps, size 3,6 x 6,5 mm, curved right

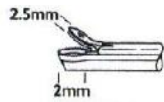

37-70-230-736

Durchneidende Blakesley Zange mit Absaugen, Größe 2,5 x 2,0 mm, Länge 105 mm, gerade
Thru Bite Blakesley forceps wit Suction, size 2,5 x 2,0 mm, Shaft Length 105 mm, Straight

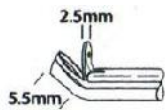

37-70-230-737
 gewinkelt

Durchneidende Blakesley Zange mit Absaugen, Größe 2,5 x 5,5 mm, Länge 95 mm
Thru Bite Blakesley forceps wit Suction, size 2,5 x 5,5 mm, Length 95 mm, upturned

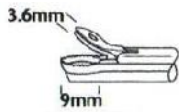

37-70-230-738

Durchneidende Blakesley Zange mit Absaugen, Größe 3,6 x 9,0 mm, Länge 105 mm, gerade
Thru Bite Blakesley forceps wit Suction, size 3,6 x 9,0 mm, Shaft Length 105 mm, Straight

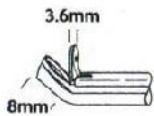

37-70-230-739
 gewinkelt

Durchneidende Blakesley Zange mit Absaugen, Größe 3,6 x 8,0 mm, Länge 95 mm
Thru Bite Blakesley forceps wit Suction, size 3,6 x 8,0 mm, Length 95 mm, upturned



37-70-230-740

Durchneidende Blakesley Zange mit Absaugen, Größe 4,8 x 14,0 mm, Länge 105 mm, gerade
Thru Bite Blakesley forceps wit Suction, size 4,8 x 14,0 mm, Shaft Length 105 mm, Straight



Lightweight forceps design with
 backbiting jaws.

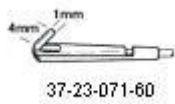









Lightweight forceps design with
 backbiting jaws.

| | | |
|---------------------|-------------------------------|------------|
| 37-23-071-60 | Pediatric Backbiter, straight | 1 x 4 mm |
| 37-23-071-70 | Pediatric Backbiter, right | 1 x 4 mm |
| 37-23-071-80 | Pediatric Backbiter, left | 1 x 4 mm |
| 37-23-071-90 | Medium Backbiter, straight | 1,5 x 8 mm |
| 37-23-072-00 | Medium Backbiter, right | 1,5 x 8 mm |
| 37-23-072-10 | Medium Backbiter, left | 1,5 x 8 mm |
| 37-23-072-20 | Large Backbiter, straight | 2 x 10 mm |
| 37-23-072-30 | Large Backbiter, right | 2 x 10 mm |
| 37-23-072-40 | Large Backbiter, left | 2 x 10 mm |



Lightweight forceps design with backbiting jaws.

| | | | |
|---|---------------------|-------------------------------|------------|
|  | 37-23-071-60 | Pediatric Backbiter, straight | 1 x 4 mm |
|  | 37-23-071-70 | Pediatric Backbiter, right | 1 x 4 mm |
|  | 37-23-071-80 | Pediatric Backbiter, left | 1 x 4 mm |
|  | 37-23-071-90 | Medium Backbiter, straight | 1,5 x 8 mm |
|  | 37-23-072-00 | Medium Backbiter, right | 1,5 x 8 mm |
| | 37-23-072-10 | Medium Backbiter, left | 1,5 x 8 mm |
|  | 37-23-072-20 | Large Backbiter, straight | 2 x 10 mm |
|  | 37-23-072-30 | Large Backbiter, right | 2 x 10 mm |
|  | 37-23-072-40 | Large Backbiter, left | 2 x 10 mm |

HUBER

Universalgriff
Universal Handle

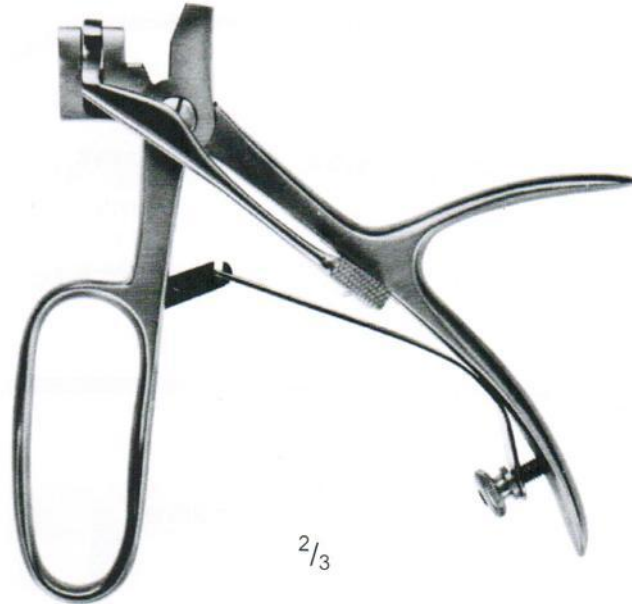

40-45-470-00

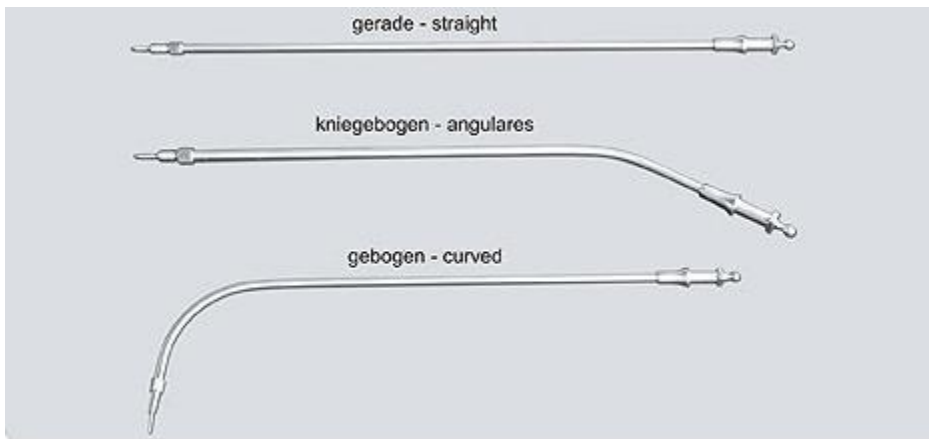

| Länge Lenght | gerade straight | kniegebogen angulares | gebogen curved |
|-----------------|--------------------|--------------------------|-------------------|
| 10 cm | 40-45-470-10 | | |
| 12 cm | 40-45-470-12 | | |
| 15 cm | 40-45-470-15 | | |
| 18 cm | 40-45-470-18 | | |
| 20 cm | 40-45-470-20 | 40-45-477-20 | 40-45-475-20 |
| 25 cm | 40-45-470-25 | 40-45-477-25 | 40-45-475-25 |
| 30 cm | 40-45-470-30 | 40-45-477-30 | 40-45-475-30 |
| 35 cm | 40-45-470-35 | 40-45-477-35 | 40-45-475-35 |
| 40 cm | 40-45-470-40 | 40-45-477-40 | 40-45-475-40 |
| 45 cm | 40-45-470-45 | 40-45-477-45 | |
| 50 cm | 40-45-470-50 | 40-45-477-50 | |
| 60 cm | 40-45-470-60 | 40-45-477-60 | |

Aufsätze gerieft und scharfe Löffel Cutting and Grasping Forceps Tips



Zangenaufsatz
gerieft
serrated
40-45-480-00



Zangenaufsatz
Hechtmal
40-45-482-00



Baracani
40-45-481-00



Fraenkel
lange Löffel
40-45-483-00



Lange, ovale Löffel
Fig. 1 40-45-488-00
Fig. 2 40-45-488-01
Fig. 3 40-45-488-03



Bruenings, runde Löffel
Fig.1 40-45-486-02 2 mm
Fig.2 40-45-486-03 3 mm
Fig.3 40-45-486-04 4 mm
Fig.4 40-45-486-05 5 mm
Fig.5 40-45-486-06 6 mm



Bruenings, runde Löffel
aufgebogen
Fig. 1 40-45-487-02
Fig. 2 40-45-487-03
Fig. 3 40-45-487-03



Scheinman
abgewinkelte Löffel
40-45-484-00

Aufsätze durchschneidend Biopsy Forceps Tips



Krause
durchschneidend



40-45-489-00



40-45-489-01



40-45-489-02



Krause
durchschneidend



40-45-490-00



40-45-490-01



40-45-490-02



Scheinmann
durchschneidend
abgewinkelt



40-45-496-00



Rosenberg
aufeinander-
schneidend

40-45-495-00

Aufsätze durchschneidend Biopsy Forceps Tips



Schneide-Instrumentarium Cutting-Instruments



18,5cm / 7 ¼"
27-11-03-18-1801
Kopfschneider kanuliert
Schneidkapazität bis Ø1,6mm
Pin Cutter canulated
max cap. Ø1,6mm



16cm / 6 ½"
27-11-03-16-1801
"Diamant" Kopfschneider
Schneidkapazität bis Ø1,6mm
"Diamond" Pin Cutter
max cap. Ø1,6mm

Schneide-Instrumentarium Cutting-Instruments

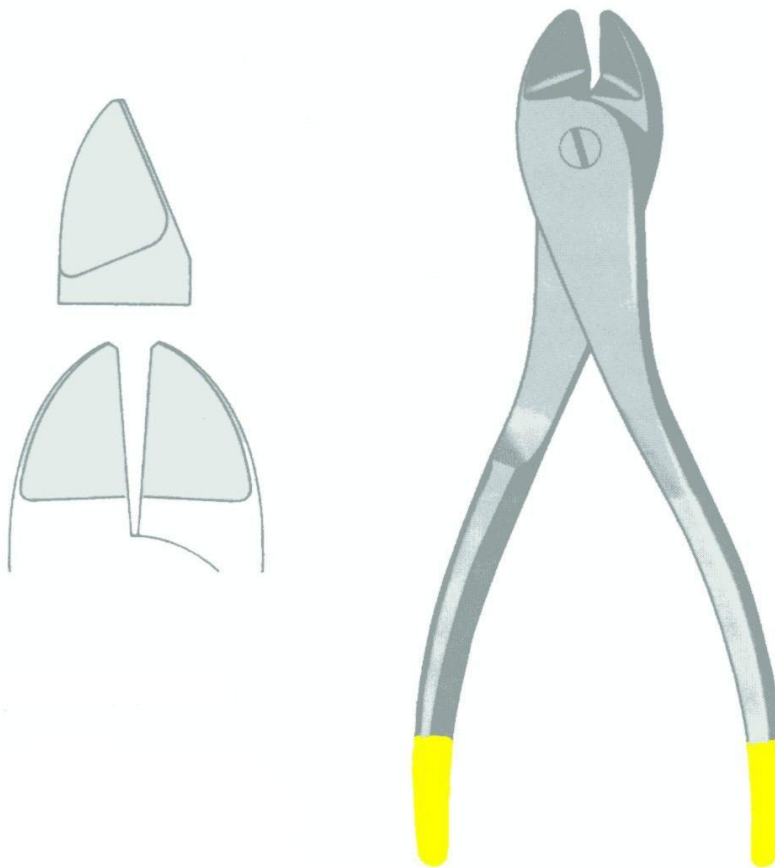

20cm / 8"

27-11-03-18-1804

TC Seitenschneider

Schneidkapazität bis Ø1,5mm

Side Cutter with welded carbide jaws

max cap. Ø1,5mm

Schneide-Instrumentarium Cutting-Instruments



23,5cm / 9 ¼"

27-11-03-23-1800

Platten-Schneidezange

zum schneiden von Stainless Steel Platten bis zu 1,5mm

Plate Cutting Forceps

for cutting stainless steel plates up to 1,5mm

Schneide-Instrumentarium Cutting-Instruments

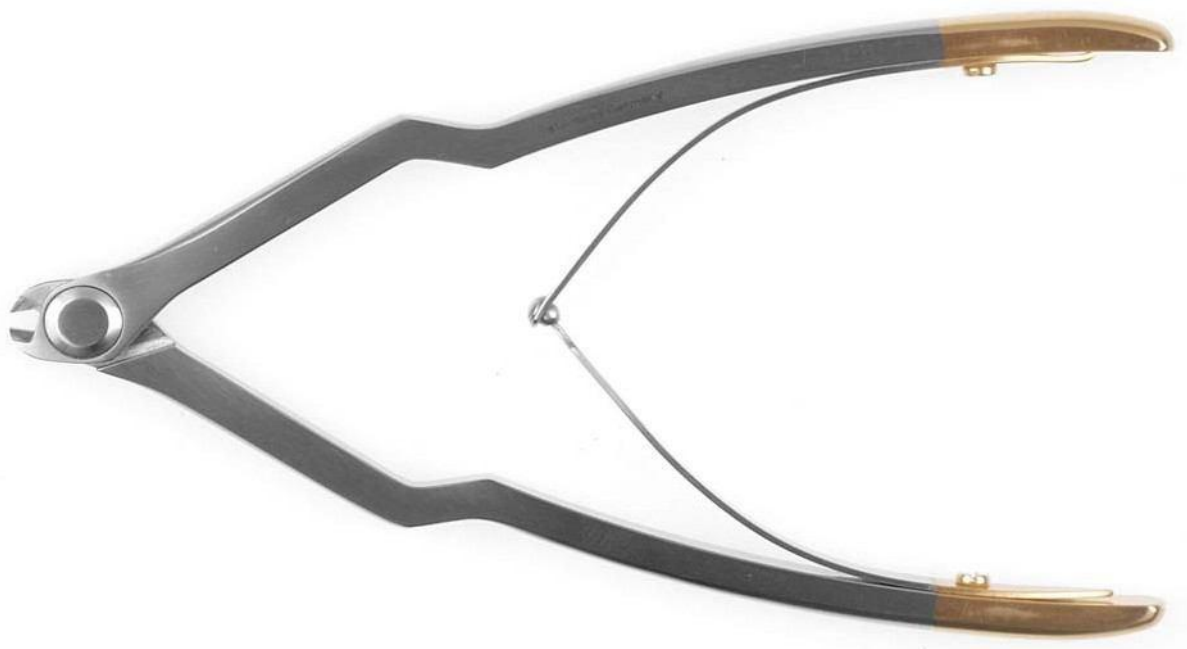

18cm / 7"

27-03-18-1600

Kabelschneidzange

Schneidkapazität bis Ø2,0mm Kabel

Cable Cutter

max cap. Ø2,0mm cable

Schneide-Instrumentarium Cutting-Instruments



26cm / 10"

27-11-03-26-1801

Kopfschneider

Schneidkapazität bis 3,2mm

Pin Cutter

max cap. 3,2mm

38cm / 15"

27- 11-03-38-1801

Kopfschneider

Schneidkapazität bis 4,7mm

Pin Cutter

max cap. 4,7mm

Schneide-Instrumentarium Cutting-Instruments



57cm / 22 1/2"

27-11-03-57-1804

Bolzenschneider

Schneidkapazität bis Ø 6,5mm

Mit abnehmbaren Griffen.

Durch eine eingebauten
Kompressionsfeder wird ein
leichtes und weiches Schneiden
der Stabes ermöglicht.

Bolt Cutter

max cap. Ø6,5mm

With removable handles.

With a integrated compression
spring is it enable cutting of rods
easy and soft.

Schneide-Instrumentarium Cutting-Instruments



27-11-03-34-1800

Stabscherer

Mit dem Stabscherer kann
Rundmaterial bis \varnothing 5,5mm
sauber und ohne erhöhte
Gratbildung abgeschert werden.

Bolt Cutter

*Shearing attention cuts cleanly
no raised burrs or sharp jagged
edges.*

max. cap 5,5mm

Mess - Instrumentarium Measuring Devices

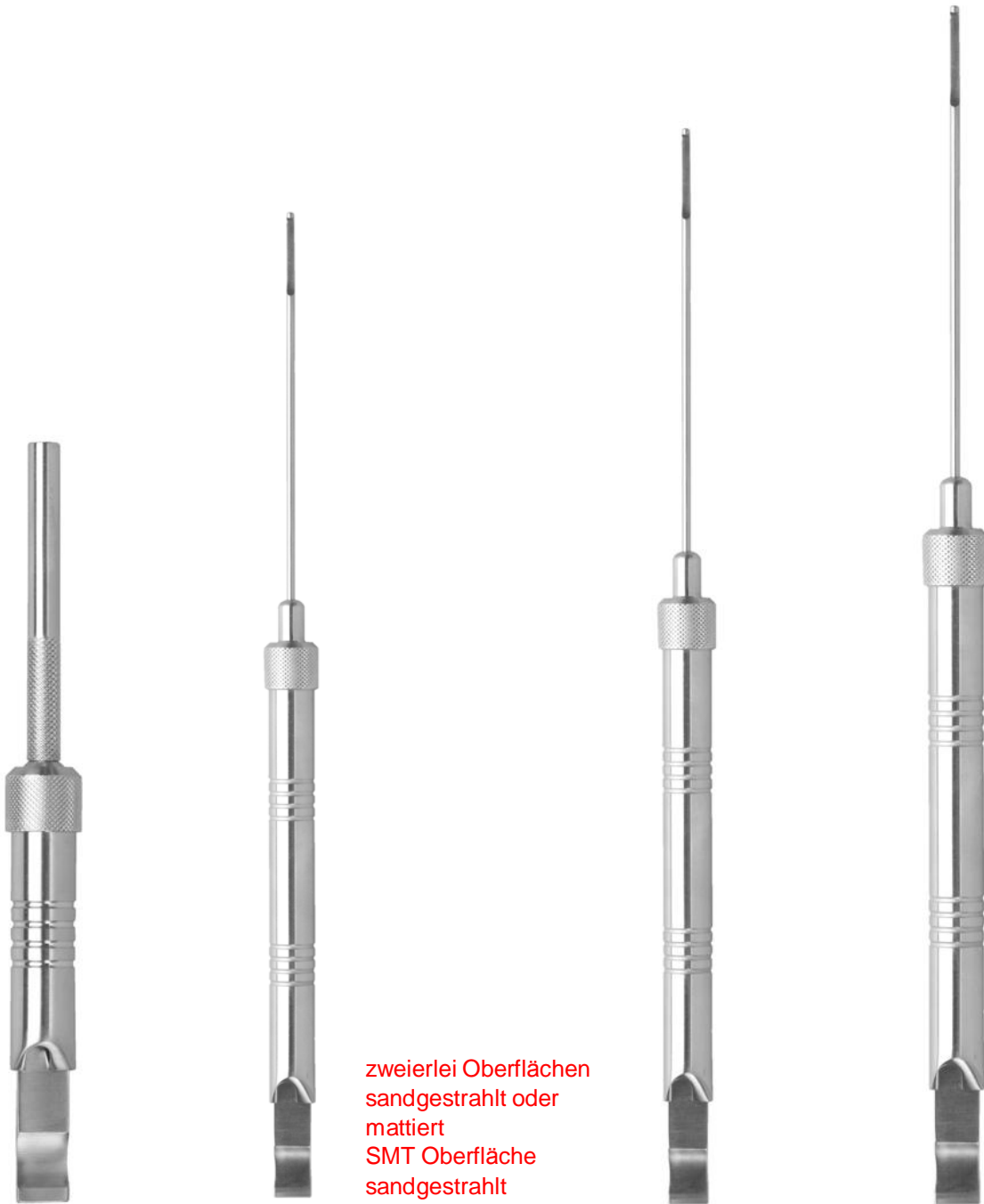

zweierlei Oberflächen
sandgestrahlt oder
mattiert
SMT Oberfläche
sandgestrahlt

13,5cm / 5 ½"
27-13-04-12-1600
Tiefenmaß /
für mini Schrauben
bis zu 30mm
Depth Gauge /
for mini Screws /
up to 30mm

20cm / 7 ¾"
27-13-04-16-1600
Tiefenmaß /
für kleine Schrauben
bis zu 60mm
Depth Gauge /
for small Screws /
up to 60mm

23cm / 9"
27-13-04-22-1600
Tiefenmaß /
für lange Schrauben
bis zu 80mm
Depth Gauge
for long Screws
up to 80mm

28cm / 11"
27-13-04-28-1600
Tiefenmaß
für extra lange Schraub.
bis zu 120mm
Depth Gauge
for extra long Screws
up to 120mm

Skalierung kann nach Kundenvorgabe angebracht werden!
Scaling can be made to customer's specifications!

Mess - Instrumentarium Measuring Devices



vorderseite / front



rückseite / back

15cm / 6"

27-13-04-15-1600

Massstab

Auf der Rückseite lassen sich durch einfache Handhabung Kirschner Bohrdrähte, Steinmann Nägel, Spiral Bohrer, Stifte und Rundstäbe messen.

Rule & Gauge

Reverse side has handy gauge to measure

K-Wires, Steinmann Pins, Twist Drills, Pins and Rods

K-Wires 0,7mm-1,6mm
0,28"-0,62"

Pins 2,0mm-4,76mm
5/64"-3/16"

Rods 5,0mm-6,35mm
0,197"-1/4"

Knochenhalte - Instrumentarium Bone Holding - Instruments

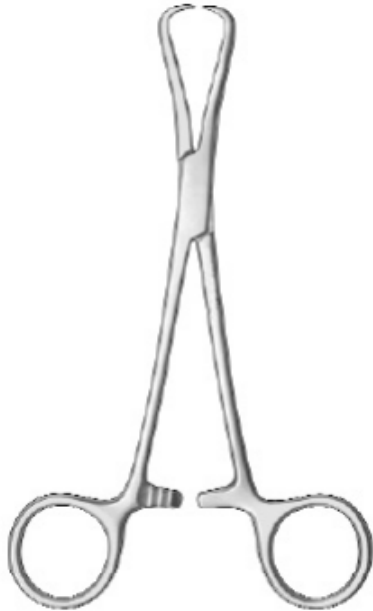

18cm / 7"
27-01-18-1600
Repositionszange / gerade / mit Spitzen
Reposition Forceps / straight / pointed tips

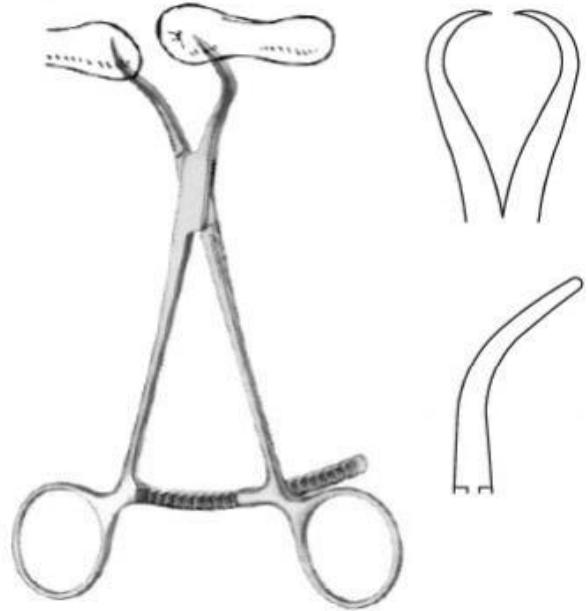

13cm / 5"
27-01-13-1602
Repositionszange / gebogen / mit Spitze
Reposition Forceps / curved / pointed tips

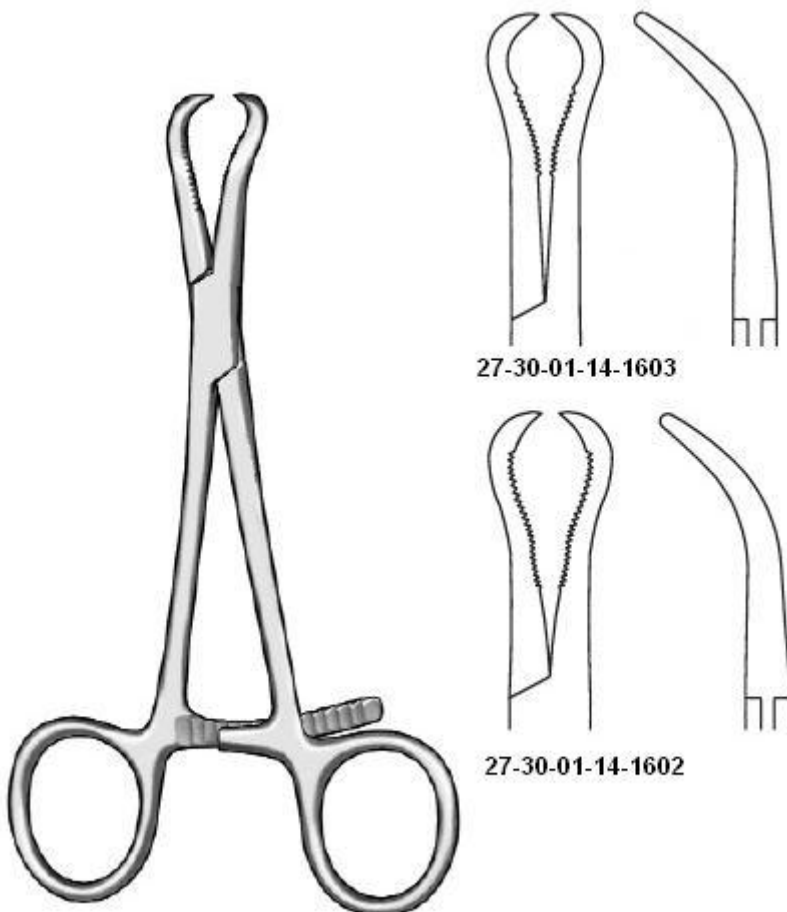

27-30-01-14-1603

27-30-01-14-1602

14cm / 5 ½"
27-01-14-1603
10 Zähne

14cm / 5 ½"
27-01-14-1602
14 Zähne
Knochenhaltezange / gebogen
Gezahnt mit Spitze
Bone Reposition Forceps / curved /
serrated with pointed tips



Knochenhalte - Instrumentarium Bone Holding - Instruments

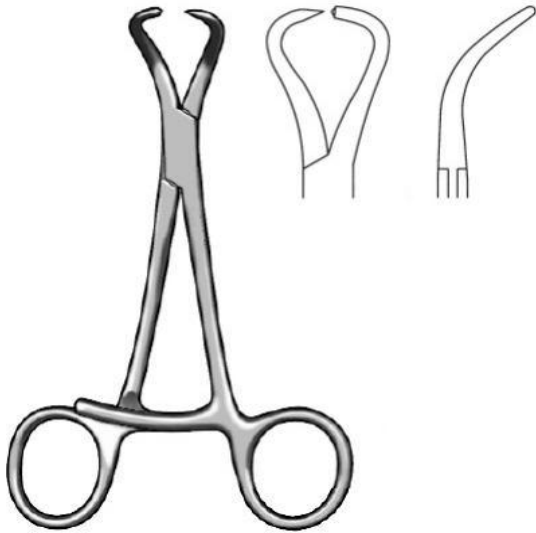

13cm / 5 ¼"

27-07-13-1601

Repositionszange für Kleinfragment / gebogen

Eine der Spitzen ist abgestumpft und bietet dadurch einen besseren Halt an den Knochen

Reposition Forceps for small fragments / curved

One tip has a stepped point for a better hold on bone.

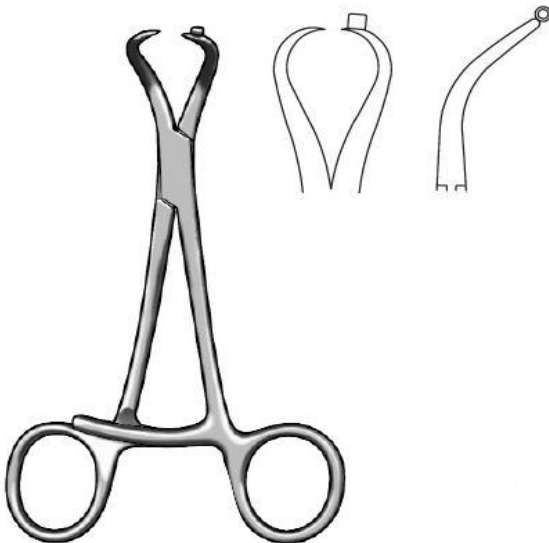

14cm / 5 ½"

27-07-13-1603

Repositionszange mit Bohrbüchse / für Kirschner Bohrdrähte

bis Ø 1,6mm / 0,62" / gebogen

Reposition Forceps with drill guide / for Kirschner wires

up to Ø 1,6mm / 0,62" / curved

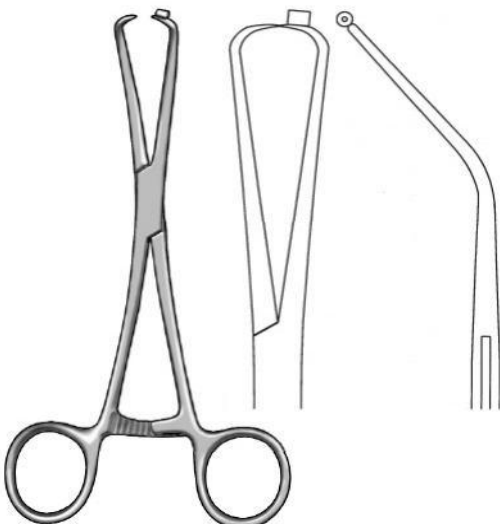

158cm / 6 ¼"

27-07-16-1600

Repositionszange mit Bohrbüchse / für Kirschner Bohrdrähte

bis Ø 0,9mm / 0,35" / gebogen

Reposition Forceps with drill guide / for Kirschner wires

up to Ø 1,6mm / 0,35" / curved



13cm / 5 ¼"

27-07-14-1600

Knochenhaltezange / Selbstzentrierend / Zahnperre
Bone Holding Forceps / Self-centering / ratched fication



Knochenhaltezange Farabeuf
Bone Holding Forceps Farabeuf

20cm : **27-01-20-1810**

25cm : **27-01-25-1835**



Rippenkontraktor

14cm : **28-11-14-1600**

16cm : **28-11-16-1600**

20cm : **28-11-20-1600**

Becken - Instrumentarium Pelvic - Instruments



27-02-25-1800-01

Abstützteller / passend zu Pelvic / mit Schnellverschluss
Spike Disk / compatible to Pelvic / with speed lock

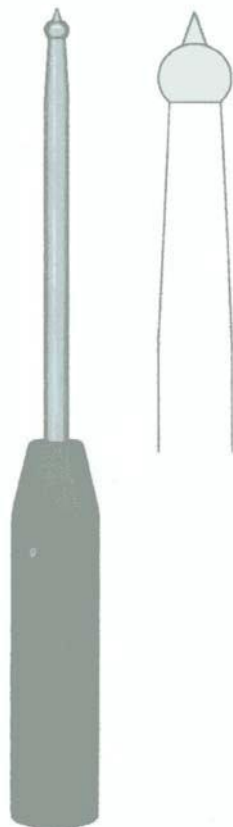

30cm / 12"

27-07-30-1600

Kugel-Spies gerade
Ball Spike straight

Hämmer Mallets



19cm / 7 1/2"

27-01-19-1801

Hammer Modell SMT /

Hammer mit Ausschläger / mit Kunststoff- und Metallbacken / Backen sind austaschbar

Mallet Modell SMT

Mallet to slap out / with plastic and metall disk / disks are exchangeable



27-01-19-1801-01

Kunststoffbacken / plan

Plastic disk / flat



27-01-19-1801-03

Metallbacken / plan

Metal disk / flat

Hämmer Mallets



400g

27-01-35-1601

Auszugshammer für Feststellzange

Extraction mallet for Locking Pliers

700g

27-01-40-1601

Auszugshammer für Feststellzange

Extraction Mallet for Locking Pliers

Stab-Biegeinstrumente Rod-Benders

Schnelle und einfache Verstellung der Kurvenscheibe
Quickly and easily displacement of the center knob

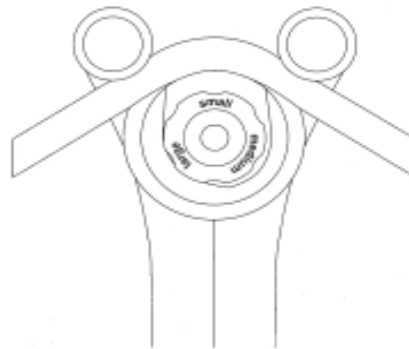
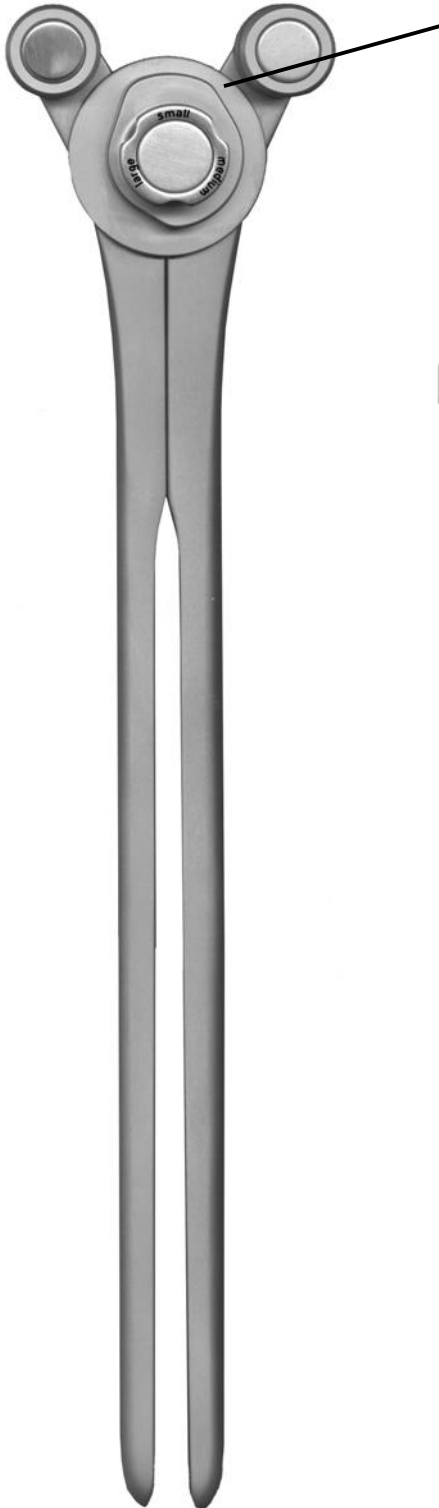

28,5cm / 11 "

27-02-28-2401 Universal bis zu-/ *Universal up to-* Ø7,0mm

27-02-28-2402 Nur für-/ *Only for-* Ø5,5mm

27-02-28-2403 Nur für-/ *Only for-* Ø6,0mm

Stabbieger

zum Biegen von Stäben bis Ø7,0mm.

Durch eine leicht und schnell verstellbare Kurvenscheibe können Stäbe unterschiedlicher Durchmesser leicht bis stark gebogen werden

Rod Bender

bends rods up to Ø7,0mm

Adjustable center knob allows rods to be bent to different diameters-slight to strong bents.

Stab-Biegeinstrumente Rod-Benders



20cm / 7 ¾"

27-02-18-1801 Universal

27-02-18-1802 Für Stäbe-/ For rods- Ø3,0-Ø4,0mm

Biegezange für Rundstäbe

Bending Forceps for Rods



Soderformen / *Special Shapes*



Platten-Biegeinstrumente Plate-Benders

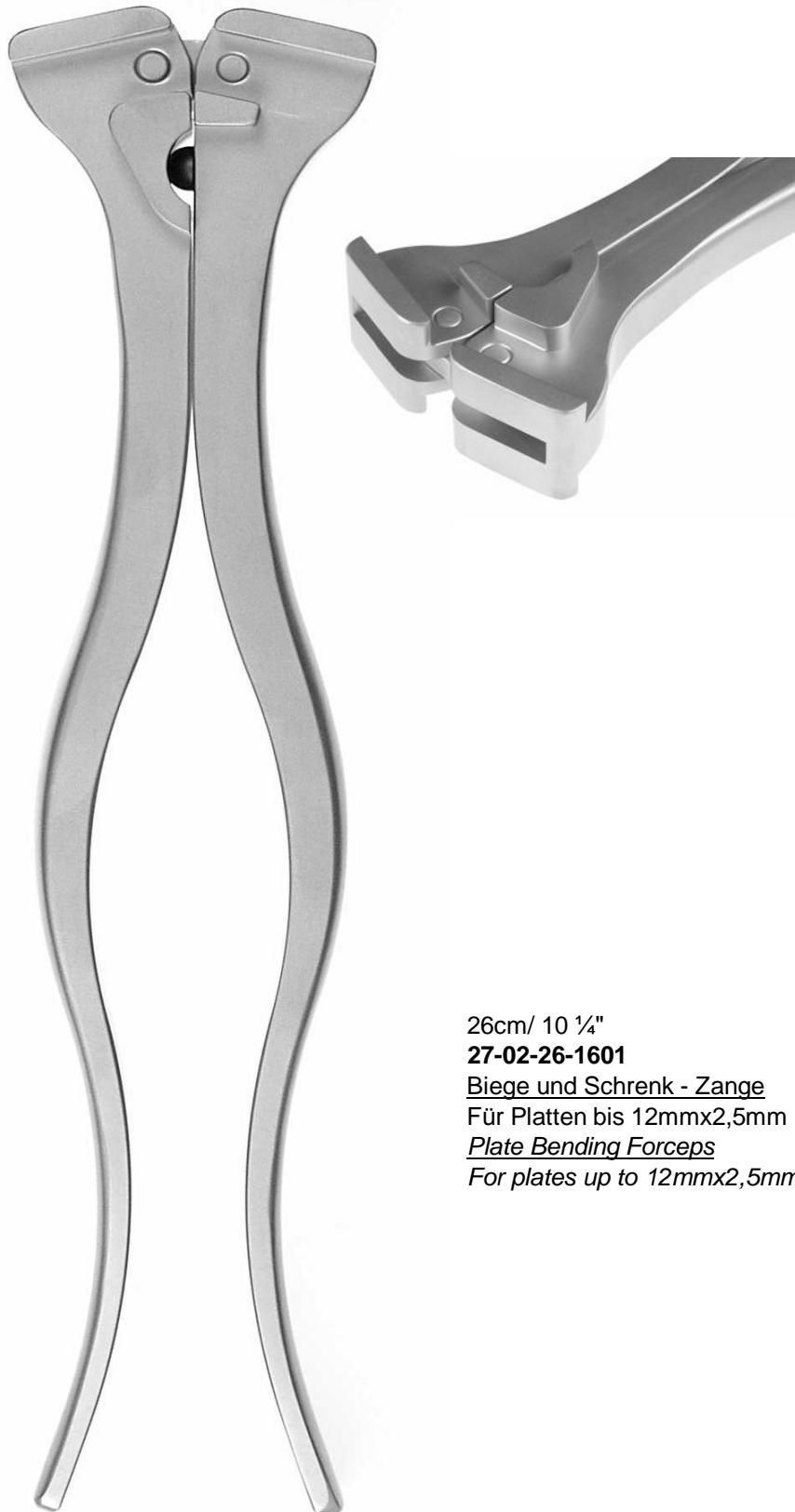

26cm/ 10 1/4"

27-02-26-1601

Biege und Schrenk - Zange

Für Platten bis 12mmx2,5mm

Plate Bending Forceps

For plates up to 12mmx2,5mm

Platten-Biegeinstrumente Plate-Benders



20cm/ 7 ¾"

27-02-20-1601 Für Platten bis-/ For plates up to- 1,6mm

21cm/ 8 ¼"

27-02-22-1601 Für Platten- / For plates- 2,7mm bis 3,5mm

24cm/ 9 ½"

27-02-24-1601 Für Platten bis-/ For plates up to- 3,0mm

Biegezange für Platten

Bending Plier for Plates



43cm/ 17"

27-02-43-0101

Biegeapparat

Für Platten bis 6mm

Bedingpress

For plates up to 6mm

Platten-Biegeinstrumente Plate-Benders



20cm/7,9"

27-02-19-1601

Biegeeisen

Biegen und Schrenken für 3,5
und 4,5mm Platten

Bending iron

*Bending and contouring for
3,5 and 4,5mm plates*

Biegeeisen

Biegen und Schrenken für 2,7
und 3,5mm Platten

Bending iron

*Bending and contouring for
2,7 and 3,5mm plates*

Platten-Biegeinstrumente Plate-Benders



24cm/ 7 1/2"

27-02-24-1602

Schrenkeisen

Für Standard-Platten und Stäbe

Bending iron

for standard plates and wire



14cm/ 5 ½"
27-02-14-1602
Schrenkeisen
Für kleine Platten
Bending iron



14cm/ 5 ½"
27-02-14-1603
Schrenkeisen
Für kleine Platten
Bending iron



13,5cm/ 5,3"
27-02-14-1604
Schrenkeisen
Für Standard-Platten
Bending iron
for standard plates

Schraubendreher und Schlüssel Screw Driver



19,5cm/ 7,75", 2,5mm 6-Kant (Hex)
27-06-20-1802
Schraubenhaltehülse

19,5cm/ 7,75"
27-06-20-1800
Schraubendreher
6-Kant mit sterilisierbarem Ferrozellgriff
und Schraubenhaltehülse
Screw driver with handle



A:
11,5 cm/ 3,5 mm QC
27-06-10-1803
Schraubendreher 6-Kant
Screwdriver Hex

B:
10 cm/ 4", 2,5mm 6-Kant (Hex)
27-06-10-1810
Schraubendrehereinsatz
Screw Driver Insert

Schraubendrehergriffe Screw driver handle



11cm/ 4 1/4"

27-06-11-1600

Handstück für AO-Ansatz

Tap Handle for AO-Shaft

10,5cm/ 4 1/4"
27-06-11-1601

Handstück für Dental-Ansatz

Tap Handle for Dental-Shaft

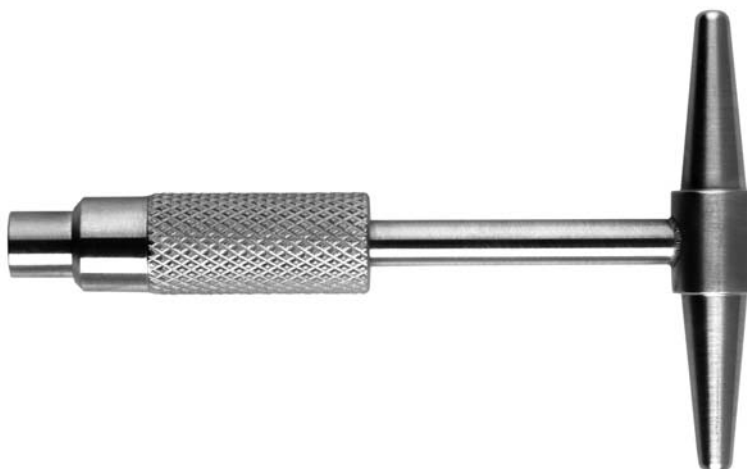

83mm Gesamtlänge

27-06-00-1602

160mm Gesamtlänge

27-06-16-1600

T-Griff mit AO-Ansatz

T-Handle conullated for AO-Shaft

Schraubendrehergriffe Screw driver handle



27-06-10-1805
Klingen-Adapter mit T-Griff
Quick Couplin T-Handle



27-06-18-1800
Schraubendrehergriff mit Schnellkupplung
Quick Couplin Handle

Schraubendreher für Griffe Screw Driver for handle



27-06-17-1808

Kardanverlängerung
Kardanverlängerungsstange und
Klingenadapter Aufnahme
Universal Quick Couplin
long Cardan Joint



17cm/ 6 3/4"

27-06-14-1800

Schraubendreher ohne Griff
Schlitz-Ansatz
Screw driver shaft
Single slot



17cm/ 6 3/4"

27-06-14-1803

Schraubendreher ohne Griff
Kreuzschlitz-Ansatz
Screw driver shaft
Cross slot



17cm/ 6 3/4"

27-06-14-1804

Schraubendreher ohne Griff
Philips-Ansatz, groß
Screw driver shaft
Philips, large



17cm/ 6 3/4"

27-06-14-1805

Schraubendreher ohne Griff
Philips-Ansatz, klein
Screw driver shaft
Philips, small



17cm/ 6 3/4", 3,5mm 6-Kant (Hex)

27-06-14-1806

Schraubendreher ohne Griff
Hex-Ansatz
Screw driver shaft
Hexagonal



Schraubendreher für Griffe Screw Driver for handle



17cm/ 6 ¾", 2,5mm 6-Kant (Hex)

27-06-14-1807

Schraubendreher ohne Griff

Hex-Ansatz

Screw driver shaft

Hexagonal

17cm/ 6 ¾", 3,0mm 6-Kant (Hex)

27-06-14-1808

17cm/ 6 ¾", 4,0mm 6-Kant (Hex)

27-06-14-1809

17cm/ 6 ¾", 4,5mm 6-Kant (Hex)

27-06-14-1810

17cm/ 6 ¾", 5,0mm 6-Kant (Hex)

27-06-14-1811



27-06-00-1801

Schraubendreher für Griff

Ansatz mit 11cm Kardan-Nuß

Screw driver for handle

Schraubendreher Kardanschlüssel Screw driver



27-06-17-1600
Kardanschlüssel
11mm, sandgestrahlt
Socket Wrench
11mm, glass bead



9,0 cm
Oberfläche mattiert: **27-07-09-1801**
Oberfläche Glasgestrahlt: **27-07-09-1601**
Plattenspanner, 9cm
Spannweg 20mm
Articulated Length of Tension Device
9 cm with Indicator, spanning 20mm

Platten- und Schraubeninstrumentarium Gewebeschutzhülsen und Bohrbuchsen Tap sleeve and Drill sleeve

15,5cm/ 4,5"

27-05-15-1600

Gewebeschutzhülsen

Mini-Bohrlehre Ø 1,1mm und 1,5mm

Tap sleeve

*Mini drill sleeve for drill bit Ø 1,1mm
and 1,5mm*



27-05-00-1602

Gewebeschutzhülsen und Bohrlehre

für Bohrer Ø 2,5mm und Gewindeschneider Ø 3,5mm

Tap sleeve

for drill Ø 2,5mm and 3,5mm

27-05-00-1603

Steckbohrbuchse

für Bohrer Ø 2,5mm

Tap sleeve and drill sleeve

for drill Ø 2,5mm



Platten- und Schraubeninstrumentarium Gewebeschutzhülsen und Bohrbuchsen Tap sleeve and Drill sleeve



27-05-00-1604
Ziel- und Plattenbohrbuchse
für Bohrer Ø 2,0mm
Tap sleeve and drill sleeve
for drill Ø 2,0mm



27-05-00-1605
Bohrlehre für Plattenspanner
für Bohrer Ø 3,2mm
Drill sleeve for tension device
for drill Ø 3,2mm

Platten- und Schraubeninstrumentarium Gewebeschutzhülsen und Bohrbuchsen Tap sleeve and Drill sleeve



11,5cm/ 4,5"

27-05-12-1601

Bohrlehre für Rund- und Halbrohrplatten
für Bohrer Ø 3,2mm

Drill sleeve for round-hole and semitibular plates
for drill Ø 3,2mm



27-05-00-1604

Ziel- und Plattenbohrbuchse
für Bohrer Ø 2,0mm

Tap sleeve and drill sleeve
for drill Ø 2,0mm



27-05-00-1605

Bohrlehre für Platten-
spanner

für Bohrer Ø 3,2mm

Drill sleeve for tension
device

for drill Ø 3,2mm

Platten- und Schraubeninstrumentarium Gewebeschutzhülsen und Bohrbuchsen

Tap sleeve and Drill sleeve

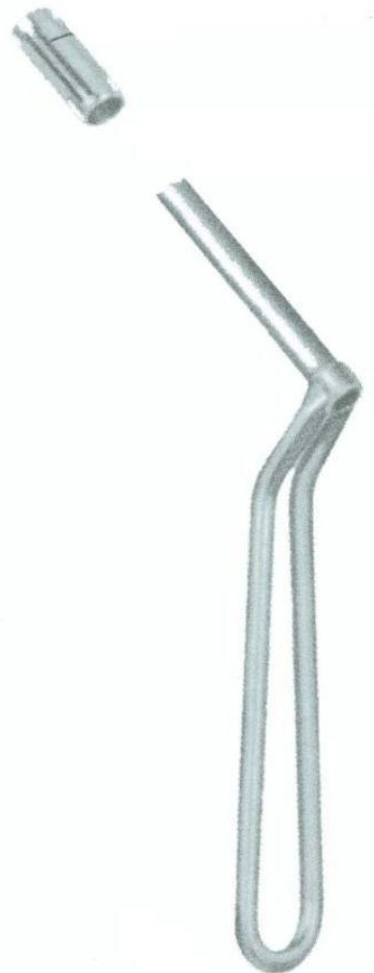

14,5cm/ 5 3/4"

27-05-15-1601

Gewebeschutzhülse

Ø 4,5mm

Tap sleeve

Ø 4,5mm



15cm/ 6"

27-05-15-1602

Zielgerät

für 27-05-15-1601

Drill guide

for 27-05-15-1601

Platten- und Schraubeninstrumentarium Gewebeschutzhülsen und Bohrbuchsen Tap sleeve and Drill sleeve

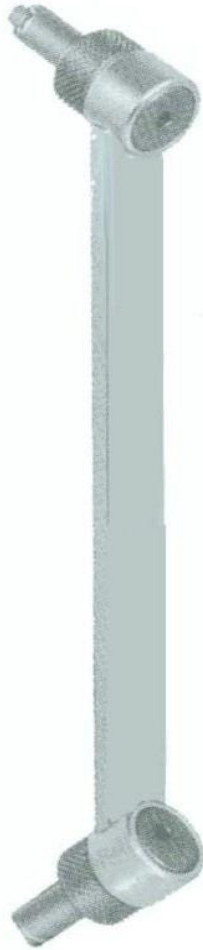

27-05-00-1600
Bohrbuchse neutral exzentrisch
für Bohrer Ø 2,5mm
Drill guide neutral and excentric holes
for drill Ø 2,5mm

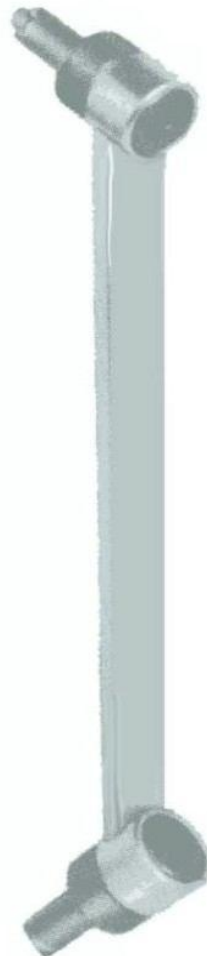

27-05-00-1601
Bohrbuchse neutral exzentrisch
für Bohrer Ø 2,0mm
Drill guide neutral and excentric
for drill Ø 2,0mm

Platten- und Schraubeninstrumentarium Gewebeschutzhülsen und Bohrbuchsen Tap sleeve and Drill sleeve

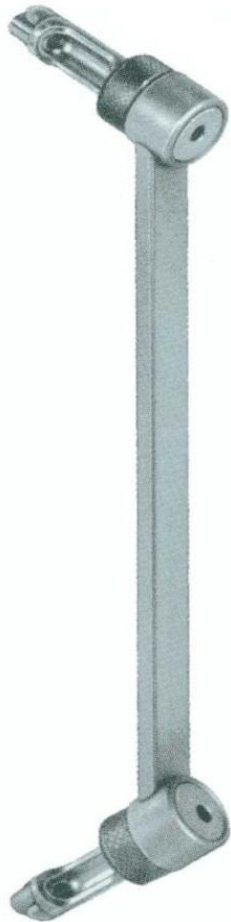

27-05-00-1606

Bohrbuchse neutral exzentrisch
für Bohrer Ø 3,2mm

Drill guide neutral and excentric
for drill Ø 3,2mm



27-05-00-1607

Gewebeschutzhülse

Tissue protector sleeve

Platten- und Schraubeninstrumentarium



A:
3,5mm - 6,5mm
27-01-09-2401
Schraubenhalte-Pinzette
mattiert
Screw Holding

B:
1,5mm - 2,7mm
27-01-09-2400
Schraubenhalte-Pinzette
mattiert
Screw Holding

Platten- und Schraubeninstrumentarium Implantat-Haltezangen zum Halten von Cages



28-01-27-1601
Haltezange
für ADD ab Höhe 16
Holding pliers
for spinal cages, long



28-01-27-1600
Haltezange
für ADD und MDS
Holding pliers
for spinal cages, short

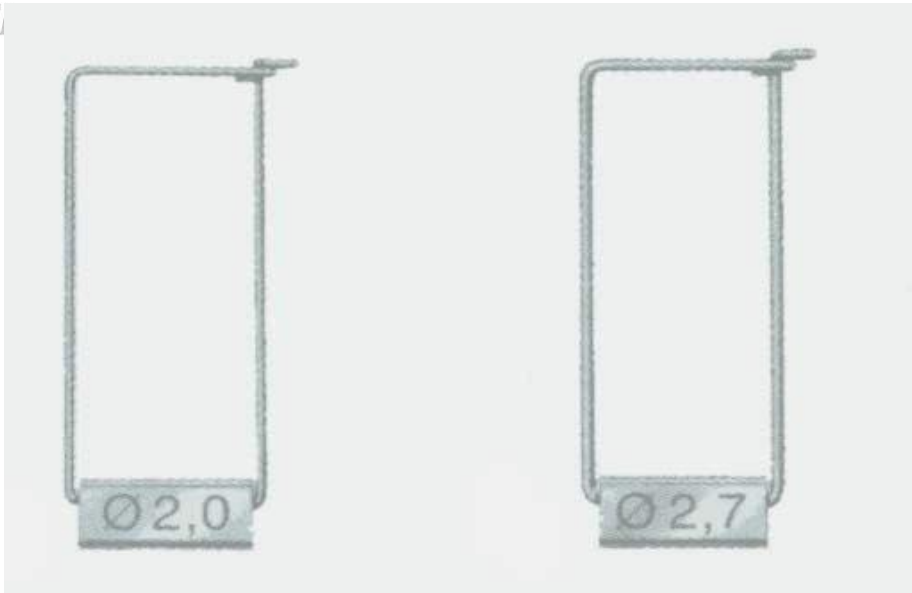

28-01-03-2000

Plattenhalteklammer

für Knochenschrauben \varnothing 3,5mm

Plateholding clip

for 3,5mm bone screws

28-01-03-2001

Plattenhalteklammer

für Knochenschrauben \varnothing 2,7mm

Plateholding clip

for 2,7mm bone screws

28-01-03-2002

Plattenhalteklammer

für Knochenschrauben \varnothing 2,0mm

Plateholding clip

for 2,0mm bone screws

Draht, & Stift Auszieher Wire & Pin Extrator

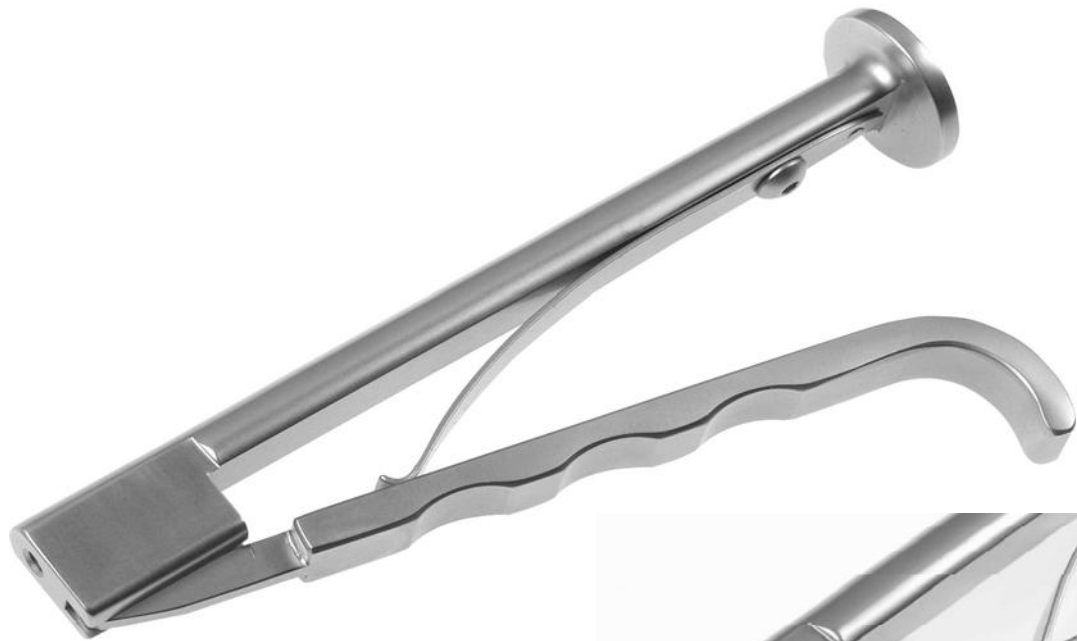

14cm / 5 ½"

27-13-01-14-1600

Stift auszieher / zum Entfernen, einsetzen
von Nägeln und Drähten bis zu 3,2mm

Pin extractor / to removal, insertion
from wires and pins up to 1,24"

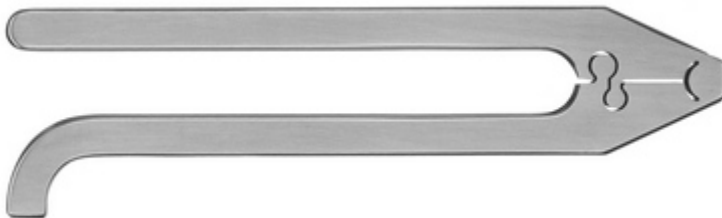

27-13-01-14-1802, 14,0 cm

Stift / Pin Auszieher 1,4mm

27-13-01-32-1802, 14,0 cm

Stift / Pin Auszieher 3,2mm

Zum ausziehen von Kirschnerdrähten und Nägeln von Ø1,2-1,4mm bzw. 3,2mm

Pin extractor / to removal, insertion from wires and pins up to 1,2-1,4 mm respectively 3,2 mm

Draht, & Stift Auszieher Wire & Pin Extractor



14cm / 5 ½"

27-01-14-2601

EASYDRIVER

Draht Eindrehinstrument 0,8 bis 1,6mm /

TC - Einsatz / Eindrehen, Herausziehen, Biegen

Pin Driver 0,28" to 0,62"

TC - Instert / Drive, Pull, Bend



Draht Führungs & Zuggeräte Wire Guides and Tractors



14,5cm / 5 ¾"
27-13-01-15-1800
Kirschner Bügel / klein
max. Öffnungsweite 12,5cm
Kirschner Bow / small
max. opening 5"

19cm / 7,5"
27-13-01-20-1800
Kirschner Bügel / mittel
max. Öffnungsw. 21,5cm
Kirschner Bow / medium
max. opening 8,5"

24cm / 9,5"
27-13-01-25-1800
Kirschner Bügel / gross
max. Öffnungsw. 25cm
Kirschner Bow / large
max. opening 10"



Bemerkung:
Jeder Kirschner Bügel wird mit 3 Haken geliefert.
Note:
Each Kirschner Bow comes with 3 hooks.

Draht Führungs & Zuggeräte Wire Guides and Tractors



18cm / 7"
27-01-00-1602
Drahtumführung / Ø45mm
Wire guide / Ø45mm



24cm / 9 ½"
27-01-00-1603
Drahtumführung / Ø70mm
Wire guide / Ø70mm

Über die Kannülation wird die Zuführung des Drahtes um den Knochen vereinfacht
Cannulation allows for easy feeding of wire around the bone.

Drahtspanner
Wire tightener



26cm /10"

27-08-26-1801

Drahtspanner / von 01,5mm bis 02,5mm

Wire tightener / up 01,5mm to 02,5mm

Drahtbiege-Instrumente Wire Bending Instruments

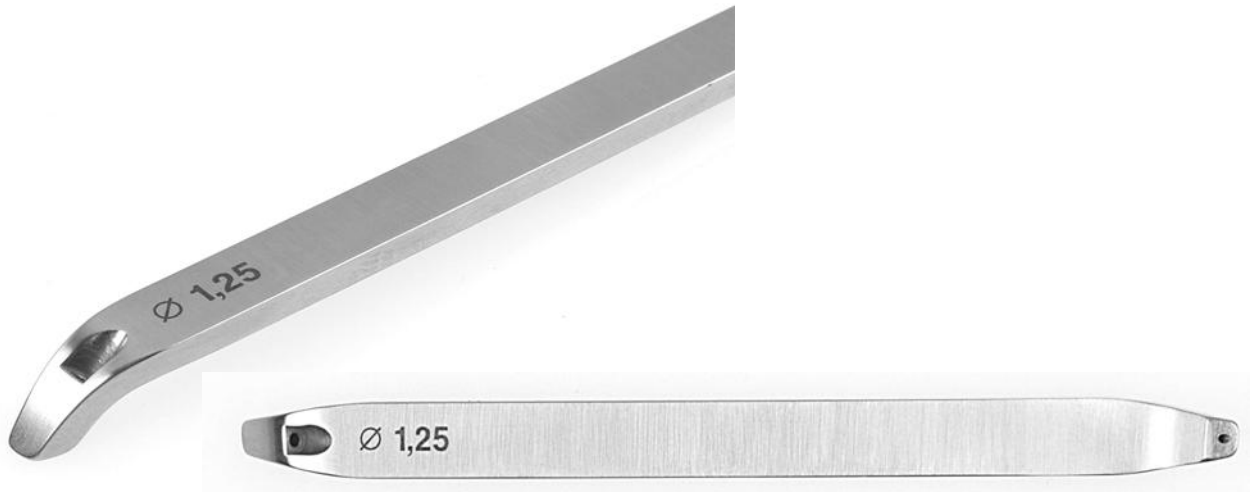

11,5cm / 4 ½"

27-02-00-1601

Biegeinstrument /

für Kirschner Drähte Ø0,8mm und Ø1,25mm

Bending Iron for Wires

for K-Wire Ø0,8mm and Ø1,25mm



12cm / 4 ¾"

27-02-00-1600

Biegeinstrument /

für Kirschner Drähte Ø1,6mm und Ø2,0mm

Bending Iron for Wires

for K-Wire Ø1,6mm and Ø2,0mm

Draht-, Plattenbiege-Instrumente

Wire, Plate Bending Instruments

Zangen Pliers

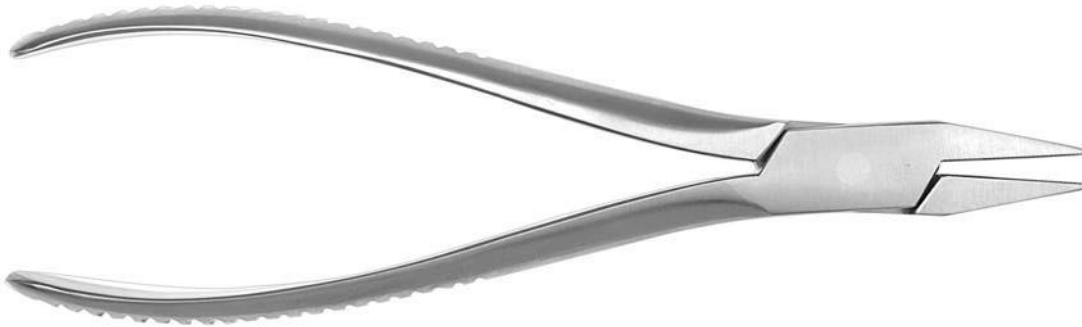

17cm / 6 3/4"

27-02-17-1802

Plattenbiegezange /

zum biegen von mini Platten bis zu 2,7mm

Plate Bending Pliers /

for bending plates up to 2,7mm



17cm / 6 3/4"

27-01-17-1601

Flachzange /

mit V-Nut / zum Ausziehen von
Kirschnerdrähten bis Ø3mm

Flat Nose Pliers /

with V-Nut / to pulling K-Wire
up to Ø3mm



17cm / 6 3/4"

27-01-17-1800

Flachzange /

für Kirschnerdrähte

Falt Nose Pliers /

for K-Wires

Zangen Pliers

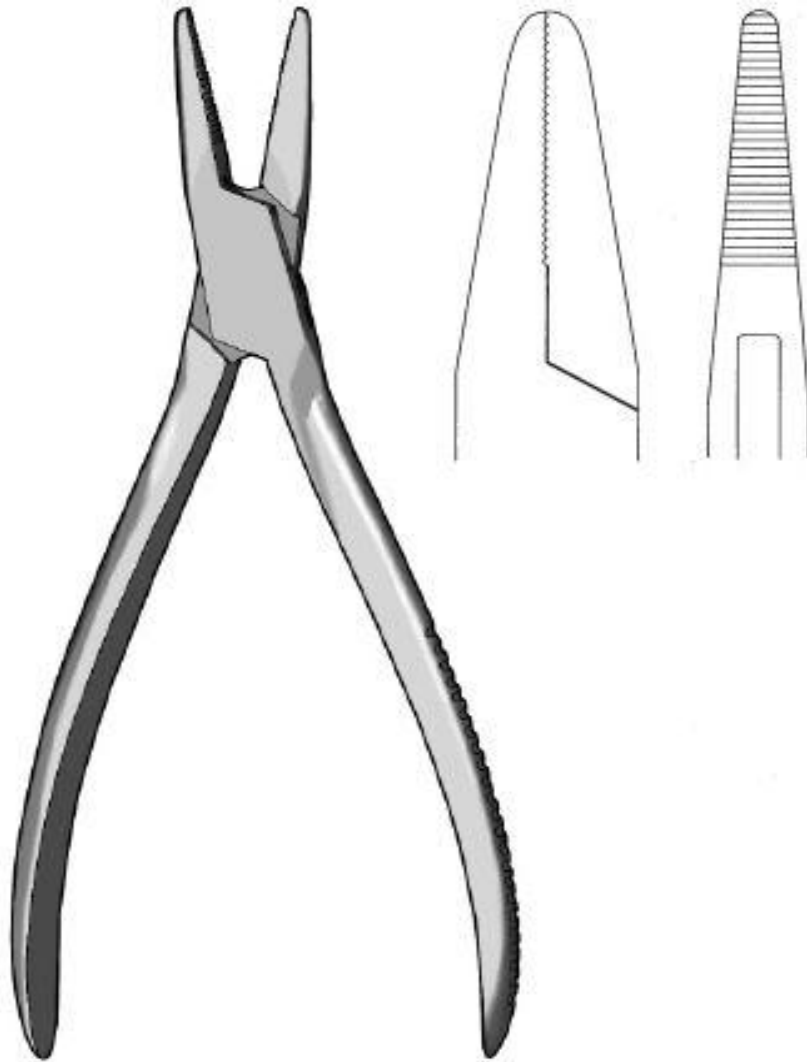

19cm / 7 1/2"

27-01-19-1602

Flachzange Spitzmaul /

Extra starkes Maulteil zum Herausziehen von K-Drähten und Steinmann Nägel. Eine geeignete Variante zur TC-Flachzange (27-01-18-1811). Maulteilstipitze 3mm

Narrow Nose Wire Pulling Forceps / Extra heavy jaws for pulling K-Wires and Steinmann Pins. An economical alternative to double action pliers. Jaws taper to 3mm.

Zangen Pliers

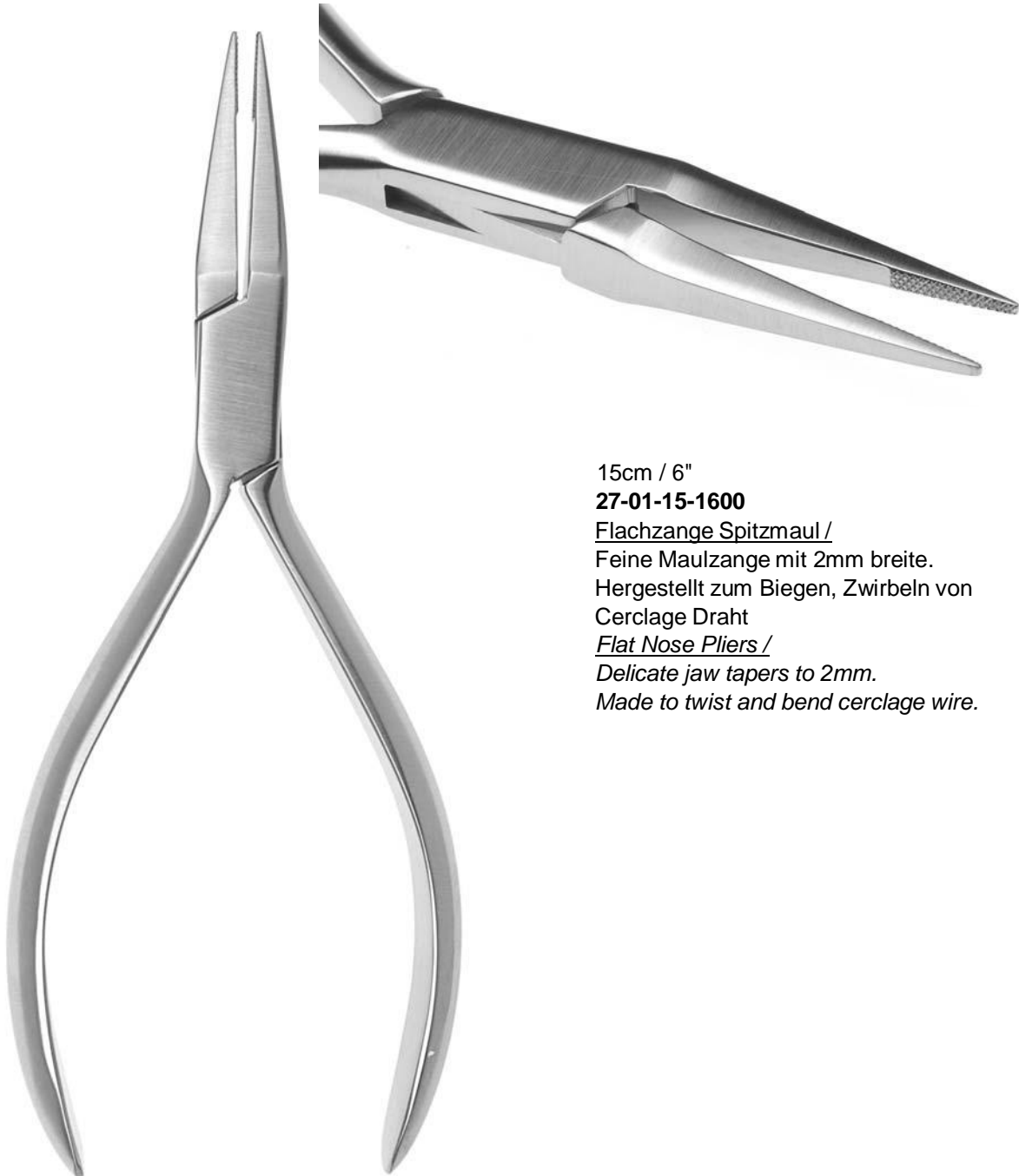

15cm / 6"

27-01-15-1600

Flachzange Spitzmaul /

Feine Maulzange mit 2mm breite.

Hergestellt zum Biegen, Zwirbeln von
Cerclage Draht

Flat Nose Pliers /

Delicate jaw tapers to 2mm.

Made to twist and bend cerclage wire.

Zangen Pliers

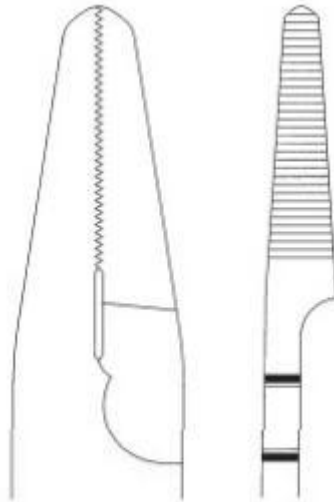

16,5 cm / 6 1/2"
27-03-17-1600

Flach- und Schneidzange / Kombination aus Flach- und Schneidzange. Mit der Schneide 0,2mm-1,5mm Cerclage Draht schneidbar. Maulteilspitze 3,5mm
Flat Nose Pliers / Combination plier and cutter. Cuts all sizes 0,2mm-1,5mm of cerclage wire. Jaw tapers to 3,5mm



14,0 cm /
27-01-14-1604
Flachzange, Spitz / Flat Nose Pliers

Draht Spann- und Zwirbel- Instrumentarium Wire Tighteners and Twisters

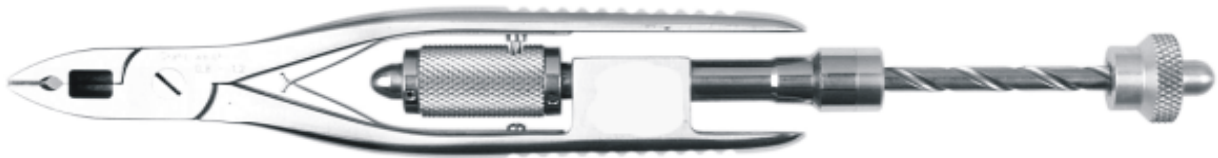

18cm / 11"

27-01-25-1800

Drahtzwirbelzange

Die SMT- Drahtzwirbelzange ist konstruiert um schnell, einfach und gleichmässig weichen Draht zu verdrehen, welche Zeit bei der Operation spart. / Kombiniert mit Schneide.

Jet Wire Twister

The SMT-Jet Wire Twister is desinged to provide fast, smooth and even twisting of soft wire, saving time in the O.R. / Combined with cutter.



22,0 cm

27-01-22-1803

Zwirbelinstrument "Loute"

Jet Wire Twister



Zum einfachen und sicheren Zwirbeln von Circlagedrähten bis Ø1,5mm Klemmen, zwirbeln und abdrehen in einem Arbeitsgang.

Draht Spann- und Zwirbel- Instrumentarium Wire Tighteners and Twisters



12cm / 4 ¾"
27-01-00-1601
Drahtspanner
Wire Tightener



23cm / 9"
27-01-23-1604
Zwirbel Instrument
Wire Tightener

Stabhaltezzangen Rod Holding Forceps



30cm / 10"
27-01-30-1603
Stabrotationszange
Rod Rotation Pliers



24,5cm / 9 ½"
27-01-30-1606 für Ø4,0mm Stab / for Ø4,0mm rods
27-01-25-1604 für Ø5,5mm Stab / for Ø5,5mm rods
27-01-25-1610 für Ø6,0mm Stab / for Ø6,0mm rods
Stabrotationszange
mit 2 Führungsstiften um Verdrehung zu vermeiden
Rod Rotation Pliers
with 2 pins to prevent torsion

Stabhaltezaugen Rod Holding Forceps



20cm / 7¾"

27-01-20-1602

kundenspezifische Maulgeometrie /
customized jaw

27-01-20-1604 für Ø5,5mm Stäbe /
for Ø5,5mm rods

27-01-20-1606 für Ø3,5mm Stäbe /
for Ø3,5mm rods

Selbsthaltende Stabhaltezange

Die Stabhaltezange ist mit folgender Oberflächengüte erhältlich: Mattiert, Sandgestrahlt & Hartverchromt

Rod Gripper

You can receive the Rod Gripper in following surfaces: mattfinished, sand blasted & hard-chrome plated



26cm / 10 ¼"

27-01-24-1800

Stabhaltezange mit Lösehebel

für Ø6,35mm Stäbe

Rod Gripper

für Ø6,35mm rods

Drahtfazzzangen Wire and Pin Bender

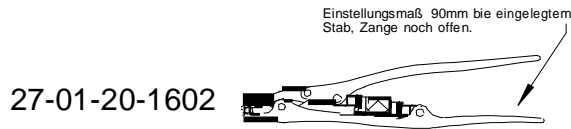

Stabhaltezange individuell einstellbar .
ohne Angaben auf 5,5mm eingestellt
mit Kontermuttern; Oberfl. Sandgestr.

27-01-20-1800

wie oben
Oberfläche mattiert

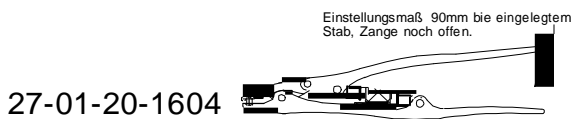

Stabhaltezange fest eingestellt
für Ø5,5 Stab
ohne Kontermuttern; Oberfl. Sandgestr.

27-01-20-2700

wie oben
Oberfläche Hochglanz

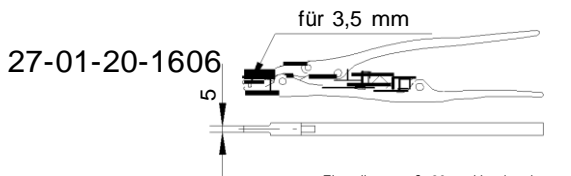

Stabhaltezange für Ø3,5mm Stäbe
Maulbreite vorne 5mm
ohne Kontermuttern; Oberfl. Sandgestr.

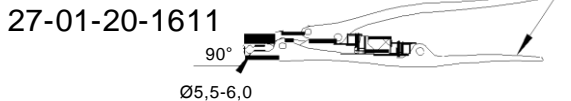

Stabhaltezange
Sonder Maulform 90° für Ø5,5-6,0
mit Kontermuttern; Oberfl. Sandgestr.

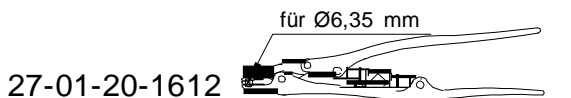

Stabhaltezange für Ø6,35mm Stab
ohne Kontermuttern; Oberfl. Sandgestr.

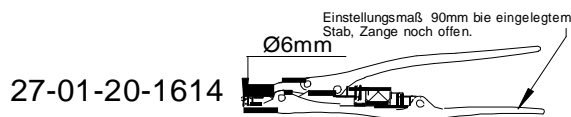

Stabhaltezange für 6,0mm Stab
mit Kontermuttern; Oberfl. Sandgestr.

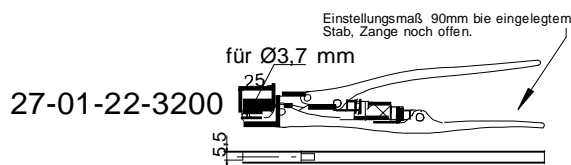

Stabhaltezange für Ø3,7mm Stäbe Maulbreite
vorne 5,5mm mit Kontermuttern;Oberfl.
Hartverchromt
27-01-22-3201 wie 27-01-22-3200 für 3,5mm Stäbe
27-01-22-3202 wie 27-01-22-3200 für 3,2mm Stäbe



Stabhaltezange mit Lösehebel
für 4,5mm Stab
ohne Kontermuttern; Oberfl.Sandgestr.



Stabhaltezange mit Lösehebel
für 6,0mm Stab
mit Kontermuttern: Oberfl.Sandgestr.

Drahtfasszange Wire and Pin Bender

Artikel Nr.

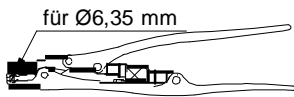
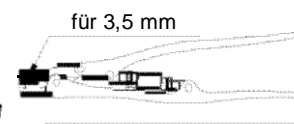
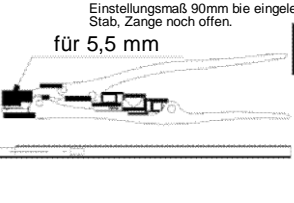
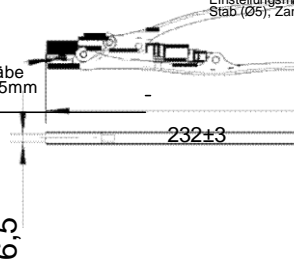
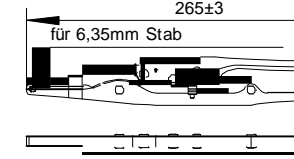
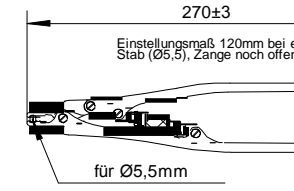
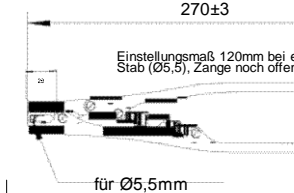
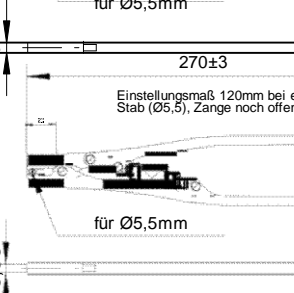
- | | | |
|---------------|---|---|
| 27-01-22-1605 |  | <p>Stabhaltezange für Ø6,35mm Stab mit Kontermuttern; Oberfl. Sandgestr.</p> |
| 27-01-20-1615 |  | <p>Stabhaltezange für Ø3,5mm Stäbe Maulbreite vorne 5mm mit Kontermuttern; Oberfl. Sandgestr.</p> |
| 27-01-22-1801 |  | <p>Stabhaltezange fest eingestellt für Ø5,5 Stab mit Kontermuttern Oberfl. mattiert Maulbreite vorne 7,0mm</p> |
| 27-01-23-1605 |  | <p>Stabhaltezange für 3,5-6,5mm Stäbe/23cm lang Maulteil 6,5mm mit Kontermuttern; Oberfl. Sandgestr.</p> |
| 27-01-24-1605 |  | <p>Stabhaltezange 26 cm mit Lösehebel mit verlängertem Maul für 6,35mm Stäbe Oberfläche Sandgestr.</p> |
| 27-01-24-1800 | | <p>wie oben Oberfläche mattiert</p> |
| 27-01-27-3200 |  | <p>Stabhaltezange fest eingestellt für Ø5,5 Stab mit Kontermuttern Oberfl. Sandgestr./hartverchromt</p> |
| 27-01-27-1801 |  | <p>27-01-27-3201 wie 27-01-27-3200 ohne Kontermuttern Stabhaltezange fest eingestellt für Ø5,5 Stab mit Kontermuttern</p> |
| 27-01-27-1802 |  | <p>Oberfl. mattiert Maulbreite vorne 7,0mm Stabhaltezange fest eingestellt für Ø5,5 Stab lange Gewindeh. mit Konterm. Lasergeschw. Oberfl. mattiert Maulbreite vorne 6,35mm</p> |

Drahtfazzangen Wire and Pin Bender



27-01-22-1601 22cm / 8 ½"
27-01-25-1601 25cm / 10"
27-01-30-1601 30cm / 12"
Spitzmaul Feststellzange
Needle Nosed Locking Pliers



27-01-18-1601 18cm / 7"
27-01-20-1601 20cm / 8"
27-01-24-1601 24cm / 9 ½"
Feststellzange
Locking Pliers

Bitte geben Sie bei einer Bestellung an, ob die Zange mit dem Auszugshammer verwendet wird, da die Mittelschraube in zweierlei Ausführungen erhältlich ist!

Please advice in your order if the pliers are used with the extraction hammer because a holding screw for extraction hammer will be needed!



27-01-35-1601 35cm / 13 ¾" = 400g
27-01-40-1601 40cm / 15 ¾" = 700g
mit Auszugshammer
with Extraction Hammer

Drahtfazzangen Wire and Pin Bender

Feststellzange & Spitzmaul Feststellzange mit Auszugshammer
Locking Pliers & Needle Nosed Locking Pliers with Extraction Hammer

Mögliche Varianten / possible variations:

für Feststellzange / for Locking Pliers

18cm: 27-01-18-1604 + 27-01-35-1601 = **27-01-39-1601**

20cm: 27-01-20-1605 + 27-01-35-1601 = **27-01-41-1601**

24cm: 27-01-24-1605 + 27-01-40-1601 = **27-01-47-1601**

für Spitzmaul Feststellzange / for Needle Nosed Locking Pliers

22cm: 27-01-22-1602 + 27-01-35-1601 = **27-01-43-1601**

25cm: 27-01-25-1602 + 27-01-35-1601 = **27-01-45-1601**

30cm: 27-01-27-1605 + 27-01-40-1601 = **27-01-51-1601**



27-01-30-1607 30,0 cm

Spitzmaul Feststellzange / Needle Nosed Locking Pliers

Parallele Backen bei Abstand 5mm. Bei eingelegtem 5mm Stab liegen beide Backen parallel in voller Länge am Draht an.

Parallel cheeks with distance 5 mm. With inlaid 5 mm of stick both cheeks lie close in parallel in full length in the wire.



27-01-23-0100 23,0 cm

Abbrechzange / Shoe puller

Zange zum Abbrechen der Gewindeflügel bei Mono und Polyaxial- Schrauben
Tongs to the cessation of the thread wings with Mono and Polyaxially screws



18,5cm / 7 ½"
27-01-18-1602
Drahtziehzange
Parallel Pliers



18,5cm / 7 ½"
27-03-18-2401
Drahtziehzange mit Seitenschneider
Schneidkapazität bis Ø1,6mm
Parallel Pliers with Side Cutter
max cap Ø1,6mm

Kundenspezifische Backen / Customized Jaws

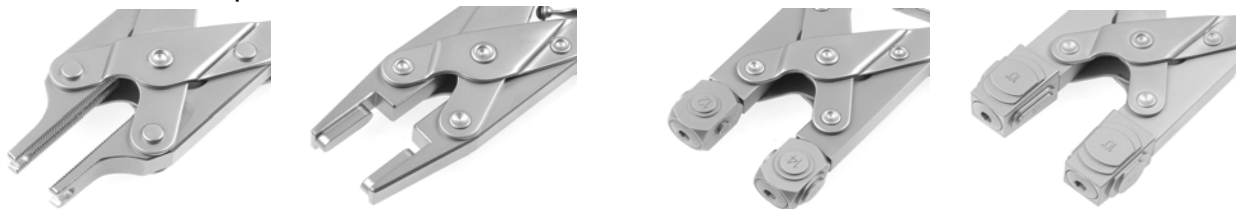

Stabhalte­zangen Rod Holding Forceps



27-01-28-1801, 28,0 cm
Stabhalte­zange, schweres Modell, gerade,
für Stäbe mit Ø6,0 mm
Rod Holding Forceps heavy model, str.,
for Ø 6.0 mm rods

27-01-28-1806, , 28,0 cm
Stabhalte­zange, schweres Modell, gerade,
für Stäbe mit Ø3,0mm
Rod Holding Forceps, heavy model, str. for
Ø 3.0 mm rods



27-01-28-1802, 28,0 cm
Stabhalte­zange, schweres Modell, gerade,
für Stäbe mit Ø6,0mm
Rod Holding Forceps, heavy model, str.,
for Ø 6.0 mm rods



27-01-28-1803, 28,0 cm
Stabhalte­zange, schweres Modell, gewinkelt,
für Stäbe mit Ø6,0mm
Rod Holding Forceps, heavy model,
for Ø 6.0 mm rods



27-01-28-1804, 28,0 cm
Stabhalte­zange, schweres Modell, gewinkelt,
für Stäbe mit Ø6,35mm
Rod Holding Forceps, heavy model,
for Ø 6.35 mm rods



27-01-30-1800, 30,0 cm
Stabhalte­zange, mittelschweres Modell.
Für Stäbe Ø6,0 -6,35mm, Glatte Halteflächen
Rod Holding Forceps moderately severe model for
Ø 6.35 mm rods, Smooth hold surfaces

27-01-30-1602, 30,0 cm

Stabhalte­zange, schweres Modell, für Stäbe
Ø 6,0 -6,35mm Glatte Halteflächen
Rod Holding Forceps heavy model for Ø 6.35
mm rods, Smooth hold surfaces

Bild in Bearbeitung
Picture in treatment

Stabhalte­zangen Rod Holding Forceps

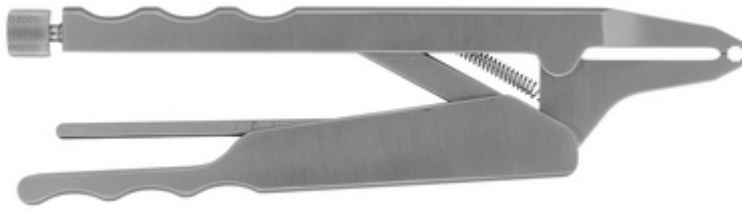

27-01-24-1807. 30 cm

*Stabhalte­zange, schwe­res Modell für Stäbe
Ø6,0 -6,35mm Ge­zahnte Halte­flächen
Mit Löse­hebel*

*Rod Holding Forceps heavy model for Ø
6.35 mm rods, Serrated hold surfaces.*

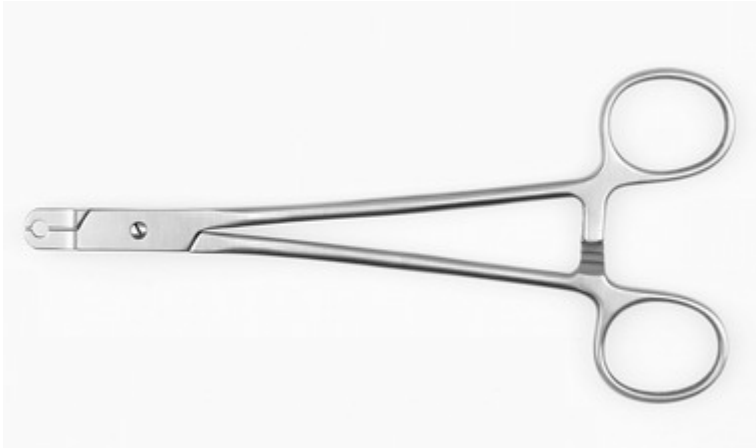

19,0 cm

Stabhalte­zange, gerade

für Stäbe Ø4,5mm : 28-01-19-1600

für Stäbe Ø6,0mm : 28-01-19-1601

für Stäbe Ø5,0mm : 28-01-19-1602

Rod Holding Forceps

for Ø4,5 mm rods : 28-01-19-1600

for Ø6,0 mm rods : 28-01-19-1601

for Ø5,0 mm rods : 28-01-19-1602



DHS - Instrumetarium DHS - Instruments



24cm / 9,5"
30-05-41-1601
DHS-Bohrer
Fräserlänge 41mm
DHS-Drill
Millinglength 41mm

24cm / 9,5"
30-05-26-1601
DCS- Bohrer kurz
Fräserlänge 26mm
DCS-Drill short
Millinglength 26mm

Spezielles Instrumentarium Special Instruments

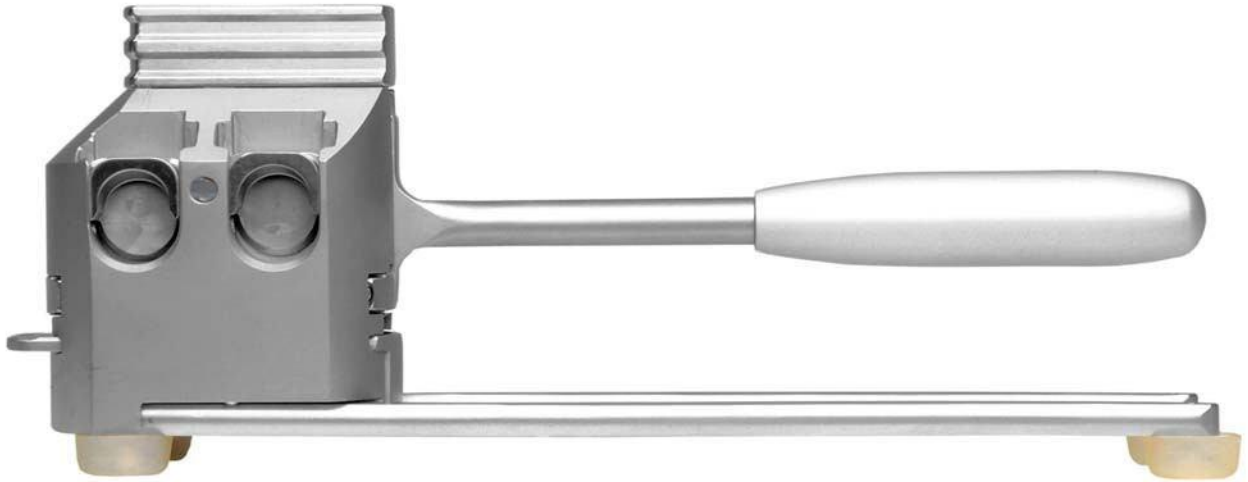

28 cm / 11"
28-03-28-1602
Knochenspan/-schaber

DBGM 200 00 516 2

Bonescraper



Spezielles Instrumentarium Special Instruments



42cm / 16,5"

28-03-42-2401

Knochenmühle

Schneidtrommel und Spannhand bitte bei der Bestellung gesondert angeben

Bone Mill



28-03-04-1801

Schneidtrommel mit 4 Schneiden in Reihe

Bohrungs - Ø 4,2mm

Cutting cylinder



28-01-00-1601

Spannhand zur Befestigung der Knochenmühle am OP-Tisch

Fixation clamp, stainless



28-03-05-1801

Schneidtrommel mit 4 Schneiden in Reihe,

Bohrungs - Ø 3,2mm

Cutting cylinder

Universal-Extraktor für Marknägel Intramedullary Nail Extractor

-schnelle und sichere Extraktion aller gängigen Marknägel mit nur einem Set
Fast and safety extraction of all Intramedullary Nails only with one Set

-Problemloses Ansetzen und Verspannen
Easy positioning and tightening

-Deutliche Verkürzung der OP - Zeit
Significant reduction of intraoperative extraction time

-Saubere, übersichtliche Aufbewahrung
Functional and convenient storage in a specially designed and fully autoclavable container system

54-09-55-0000

Universal - Marknagel - Entfernungset:

Universal - Intramedullary Nail - Removal Set:

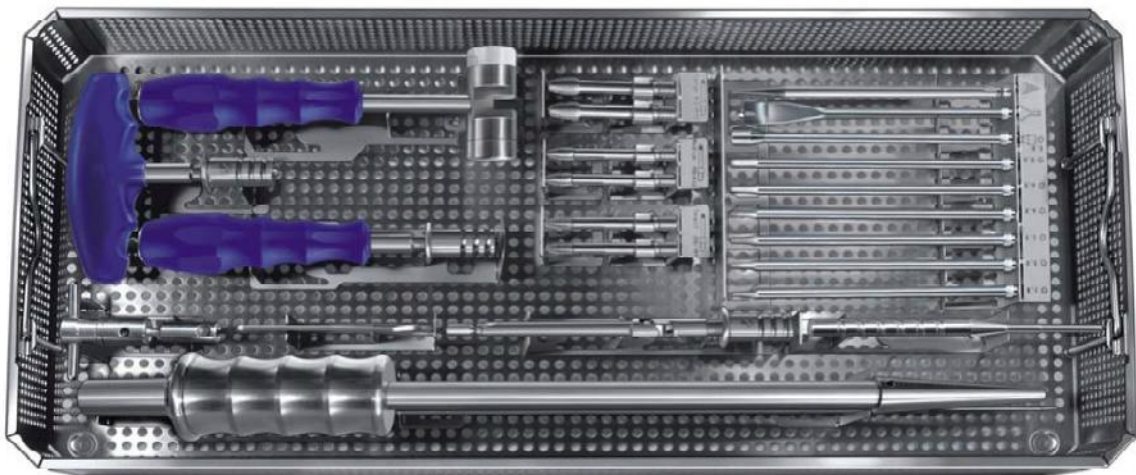

Universal-Extraktor für Marknägel

Intramedullary Nail Extractor

Inhalt

| | | |
|---------|---|------------------|
| 1 Stück | Siebeinsatz mit Halter <i>STERILISATION TRAY</i> | 54-09-55-0000-30 |
| 1 Stück | Ausschläger <i>EXTRAKTOR</i> | 27-09-55-1800 |
| 2 Stück | Spreizereinsatz Gr. 1 von 6-9mm <i>ADAPTER FOR NAIL EXTRACTOR GR1 von 6-9mm</i> | 27-09-55-1800-11 |
| 2 Stück | Spreizereinsatz Gr. 2 von 9-12mm <i>ADAPTER FOR NAIL EXTRACTOR GR 2 von 9-12mm</i> | 27-09-55-1800-12 |
| 2 Stück | Spreizereinsatz Gr. 3 von 12-15mm <i>ADAPTER FOR NAIL EXTRACTOR GR 3 von 12-15mm</i> | 27-09-55-1800-13 |
| 1 Stück | Gabelschlüssel <i>WRENCH</i> | 27-06-10-1806 |
| 1 Stück | Klinge SW 2,5 <i>DRIVER HEXAGONAL SW 2,5</i> | 27-06-25-1803 |
| 1 Stück | Klinge SW 3,0 <i>DRIVER HEXAGONAL SW 3,0</i> | 27-06-30-1803 |
| 1 Stück | Klinge SW 3,5 <i>DRIVER HEXAGONAL SW 3,5</i> | 27-06-35-1803 |
| 1 Stück | Klinge SW 4,0 <i>DRIVER HEXAGONAL SW 4,0</i> | 27-06-40-1803 |
| 1 Stück | Klinge SW 4,5 <i>DRIVER HEXAGONAL SW 4,5</i> | 27-06-45-1803 |
| 1 Stück | Klinge SW 5,0 <i>DRIVER HEXAGONAL SW 5,0</i> | 27-06-50-1803 |
| 1 Stück | Schraubendreher mit Führungsbolzen <i>SCREW DRIVER WITH GUIDE PIN</i> | 27-06-01-1803 |
| 1 Stück | Steckschlüssel <i>SOCKET WRENCH</i> | 27-06-02-1803 |
| 1 Stück | Extraktionsschraubendreher <i>CONICAL EXTRACTION SCREW</i> | 27-06-03-1803 |
| 1 Stück | Durchschlag <i>HEMOSAT</i> | 27-05-15-1800 |
| 1 Stück | T-Griff mit Adapter <i>QUICK COUPLING T-HANDLE</i> | 27-06-10-1805 |
| 1 Stück | Griff mit Adapter <i>QUICK COUPLING HANDLE</i> | 27-06-18-1800 |
| 1 Stück | Kardanverlängerung <i>UNIVERSAL QUICK COUPLING CARDAN JOINT</i> | 27-06-17-1808 |
| 1 Stück | Hammer <i>MALLET</i> | 27-01-19-1801 |

Universal-Extraktor für Marknägel Intramedullary Nail Extractor



27-06-10-1805
T-Griff mit Adapter
Quick Couplin T-Handle



27-06-18-1800
Griff mit Adapter
Quick Couplin Handle



27-01-19-1801
Hammer
Mallet Modell Schilling



27-06-17-1808
Kardanverlängerung
Universal Quick Coupling



27-06-10-1806
Gabelschlüssel
Wrench

Universal-Extraktor für Marknägel Intramedullary Nail Extractor



27-06-25-1803

Klinge SW 2,5

Driver Hexagonal SW 2,5

27-06-40-1803

Klinge SW 4,0

Driver Hexagonal SW 4,0

27-06-30-1803

Klinge SW 3,0

Driver Hexagonal SW 3,0

27-06-45-1803

Klinge SW 4,5

Driver Hexagonal SW 4,5

27-06-35-1803

Klinge SW 3,5

Driver Hexagonal SW 3,5

27-06-50-1803

Klinge SW 5,0

Driver Hexagonal SW 5,0



27-05-15-1800

Durchschlag

Punch



27-09-55-1800-11

Spreizereinsatz Gr. 1 von 6-9mm

Adapter for nail Extractor Gr 1



27-09-55-1800-12

Spreizereinsatz Gr. 2 von 9-12mm

Adapter for nail Extractor Gr 2



27-09-55-1800-13

Spreizereinsatz Gr. 3 von 12-15mm

Adapter for nail Extractor Gr 3

Universal-Extraktor für Marknägel Intramedullary Nail Extractor



27-06-02-1803
Steckschlüssel
Socket Wrench



27-06-03-1803
Extraktionsschraub-
dreher
Conical Extraction
Screw



27-09-55-1800-31
Spannstab
Tension Rod



27-09-55-1800-32
Spannstück
Tension Device



27-09-55-1800-30
Hammer
Extractor



27-09-55-1800
Ausschläger
Intramedullary Nail
Extraction Hammer

Universal-Extraktor für Marknägel Intramedullary Nail Extractor



27-01-19-1801-01
Kunststoffbacken
Spare Nylon Discs



27-01-19-1801-03
Metallbacken
Spare Steel Discs

IMPLANTS & INSTRUMENTS



**EMERGENCY INSTRUMENTS TO REMOVE
DAMAGED AND BROKEN BONE SCREWS**



EMERGENCY INSTRUMENTS TO REMOVE DAMAGED AND BROKEN BONE SCREWS (UP FROM DIAMETER 1.5 MM TO 7.0 MM SCREWS)



| |
|----------------------|
| SCREW-EXTRACTION-SET |
| 27-54-09-25-000 |
| complete |



| |
|--|
| RECOMMENDED FOR STERILIZATION CONTAINER FOR |
| 27-54-09-25-000 |
| complete |



| |
|--------------------|
| CONTAINER BOTTOM |
| 305-100 |
| 285 x 280 x 100 mm |

| |
|---------------------|
| 27-54-09-25-0000-31 |
| TRAY(Empty) |

| |
|---------------|
| CONTAINER IID |
| 300-010 |
| 285 x 280 mm |

SET - LISTING FOR SET: 27-54-09-25-000 SCREW EXTRACTION-SET COMPLETE



| SET - LISTING FOR SET: 27-54-09-25-000 SCREW- EXTRACTION - SET COMPLETE | | |
|---|--|---------|
| REF. - NO.: | PRODUCT - DESCRIPTION: | |
| 27-54-09-25-0000-31 | AI-Tray for Screw-Extraction Set-27-54-09-25-000 | -1-Pcs. |
| 28-09-15-1603 | Conical Extraction Screw for 1.5 / 2.0 mm Screws | -1-Pcs. |
| 28-09-27-1603 | Conical Extraction Screw for 2.7 / 3.5 / 4.0 mm Screws | -1-Pcs. |
| 28-09-45-1603 | Conical Extraction Screw for 4.5 / 5.0 / 6.5 / 7.0 mm Screws | -1-Pcs. |
| 28-09-15-1601 | Extraction Bolt for 1.5 mm Screws | -1-Pcs. |
| 28-09-20-1601 | Extraction Bolt for 2.0 mm Screws | -1-Pcs. |
| 28-09-27-1601 | Extraction Bolt for 2.7 mm Screws | -1-Pcs. |
| 28-09-35-1601 | Extraction Bolt for 3.5 / 4.0 mm Screws | -1-Pcs. |
| 28-09-45-1601 | Extraction Bolt for 4.5 mm Screws | -1-Pcs. |
| 28-09-65-1601 | Extraction Bolt for 5.0 / 6.5 / 7.0 mm Screws | -1-Pcs. |
| 28-09-15-1602 | Hollow Reamer for 1.5 mm Screws | -1-Pcs. |
| 28-09-20-1602 | Hollow Reamer for 2.0 mm Screws | -1-Pcs. |
| 28-09-27-1602 | Hollow Reamer for 2.7 mm Screws | -1-Pcs. |
| 28-09-35-1602 | Hollow Reamer for 3.5 / 4.0 mm Screws | -1-Pcs. |
| 28-09-45-1602 | Hollow Reamer for 4.5 mm Screws | -1-Pcs. |
| 28-09-65-1602 | Hollow Reamer for 5.0 / 6.5 / 7.0 mm Screws | -1-Pcs. |
| 28-09-15-1602-03 | Spare Reamer (Reamer Tube) for Hollow Reamer 1.5 mm (used for 1.5 mm Screws) | -1-Pcs. |
| 28-09-20-1602-03 | Spare Reamer (Reamer Tube) for Hollow Reamer 2.0 mm (used for 2.0 mm Screws) | -1-Pcs. |
| 28-09-27-1602-03 | Spare Reamer (Reamer Tube) for Hollow Reamer 2.7 mm (used for 2.7 mm Screws) | -1-Pcs. |
| 28-09-35-1602-03 | Spare Reamer (Reamer Tube) for Hollow Reamer 3.5 / 4.0 mm (used for 3.5 / 4.0 mm Screws) | -1-Pcs. |
| 28-09-45-1602-03 | Spare Reamer (Reamer Tube) for Hollow Reamer 4.5 mm (used for 4.5 mm Screws) | -1-Pcs. |
| 28-09-65-1602-03 | Spare Reamer (Reamer Tube) for Hollow Reamer 5.0 / 6.5 / 7.0 mm (used for 5.0 / 6.5 / 7.0 mm Screws) | -1-Pcs. |
| 27-46-16-1800 | Sharp Hook, length 155 mm | -1-Pcs. |
| 27-21-03-00-1600 | Mini Hexer Gouge, 4 mm | -1-Pcs. |
| 27-21-03-00-1601 | Mini Hexer Gouge, 6 mm | -1-Pcs. |
| 27-21-03-00-1603 | Mini Hexer Gouge, 10 mm | -1-Pcs. |
| | Screw Holding Forceps 20.5 cm / 8" | -1-Pcs. |
| 27-06-16-1600 | T-Handle, large with AO-Quickcoupling length 160 mm | -1-Pcs. |
| 27-54-09-25-000-01 | Template for use Broken Screw-Extraction Instruments (Guide Manual for Use) | -1-Pcs. |

27-54-09-25-000-01 TEMPLATE FOR USE BROKEN SCREW- EXTRACTION INSTRUMENTS (GUIDE MANUAL FOR USE IN SURGICAL THEATRE)

1.

Bitte Gebrauchsanweisung vor dem Sterilisieren aus der Box entfernen.
Please remove the instruction before sterilisation.

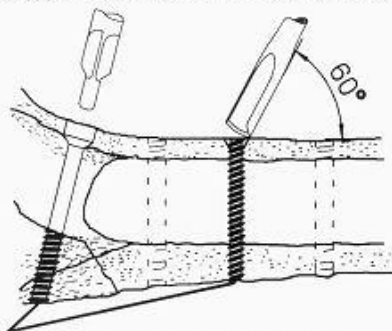

Abgebrochene Schrauben / Broken Screw / Vis Cassées / Viti Spezzate

Freilegung des Schraubenkanals und der abgebrochenen Schraube als Zentrierung für den Hohlfräser, mit Kopfraumfräser oder Spezialmeißel.

Exposure of the screw hole and the broken screw, which serves to centre the hollow reamer, using a countersink or special osteotome.

Préparation de l'orifice et de la vis cassée pour centrer le trépan au moyen de la fraise à chambrer ou du ciseau gouge spécial.

Messa a nudo del canale della vite e della vite spezzata tramite la fresa per sede conica oppure opposto scalpello.

2.

Zentrierbolzen
Centering tip
Guide de centrage
Perno di centraggio

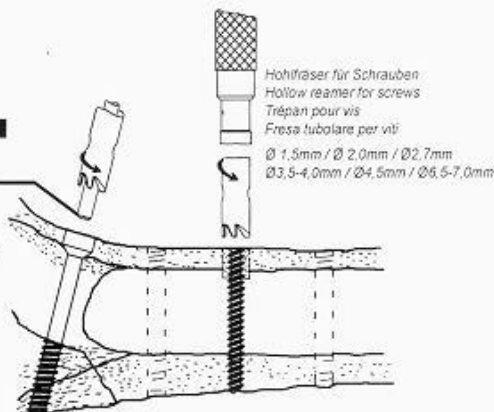

Hohlfräser für Schrauben
Hollow reamer for screws
Trépan pour vis
Fresa tubolare per viti
Ø 1,5mm / Ø 2,0mm / Ø 2,7mm
Ø 3,5-4,0mm / Ø 4,5mm / Ø 6,5-7,0mm

Mit Hohlfräser Zugang für den Extraktionsbolzen ausfräsen, Schraubenrichtungen beachten. Bei Hohlfräser Zentrierbolzen entfernen wenn der Schraubenstumpf erreicht ist.

The orientation of the screw is noted. The hole for the extraction bolt is cut using the hollow reamer. The centering tip is removed as soon as it contacts the screw fragment.

Préparer l'approche pour le boulon d'extraction à l'aide du trépan en observant la direction de la direction de la vis. Enlever le guide de centrage au moment où il entre en contact avec la vis cassée.

Aprire la via per il perno d'estrazione con la fresa tubolare osservando la direzione della vite. Estrarre il perno di centraggio dalla fresa tubolare appena si raggiunge il resto della vite.

3.

Extraktionsbolzen für Schrauben
Extracting bolt for screw
Boulon d'extraction pour vis
Perno d'estrazione per viti
Ø 1,5mm / Ø 2,0mm / Ø 2,7mm
Ø 3,5-4,0mm / Ø 4,5mm / Ø 6,5-7,0mm

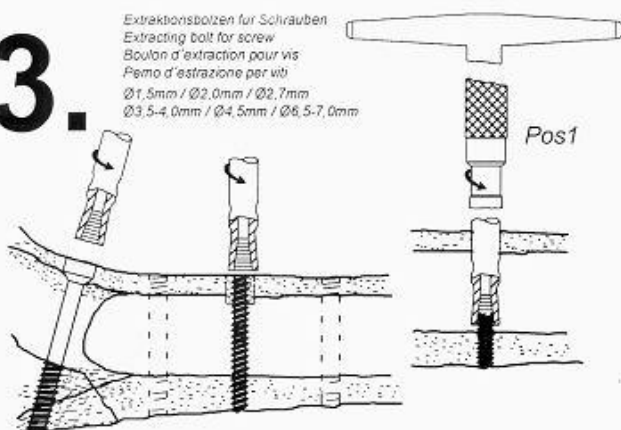

Mit Linksdrehung den Extraktionsbolzen kräftig auf den Schraubenstumpf drücken und herausdrehen.

The extraction bolt is strongly pressed onto the screw fragment and rotated anticlockwise, thus allowing the fragment to be screwed out.

Extraction de la vis en enfonceant avec force le boulon sur la vis cassée puis en le tournant de droite à gauche.

Premere forte il perno d'estrazione sulla vite spezzata ed estrarla ed estrarla girando a sinistra.

Konische Extraktions Schraube für
Conical extraction screw
Vis d'extraction conique
Vite d'estrazione conica

für / for / pour / per Ø 1,5/2,0mm
für / for / pour / per Ø 2,7/3,5/4,0mm
für / for / pour / per Ø 4,5/6,5/7,0mm#

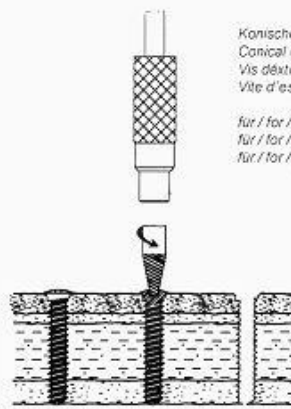

Bei beschädigtem Innensechskant passende konische Extraktionsschraube mit Griffstück Pos1 unter Druck und Linksdrehung möglichst senkrecht eindrehen und Schraube entfernen.

If the hexagonal socket is damaged, insert the fitting conical extraction screw with handle Pos1 as vertically as possible under pressure and left-hand rotation and remove the screw.

En cas d'une empreinte hexagonale intérieure endommagée, visser la vis d'extraction juste avec poignée Pos1 sous pression et rotation inversée aussi verticalement que possible et enlever la vis. In caso che l'esagone incassato è danneggiato, avvitare la vite conica per estrazione adatta con l'impugnatura Pos1 sotto pressione e torsione sinistrorsa il più verticalmente possibile e rimuovere la vite.

Conical Extraction Screws



| | |
|---------------|--|
| 28-09-15-1603 | Conical Extraction Screw for 1.5 / 2.0 mm Screws |
| 28-09-27-1603 | Conical Extraction Screw for 2.7 / 3.5 / 4.0 mm Screws |
| 28-09-45-1603 | Conical Extraction Screw for 4.5 / 5.0 / 6.5 / 7.0 mm Screws |

Hollow Reamers complete

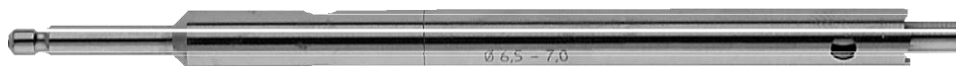

| | |
|---------------|---|
| 28-09-15-1602 | Hollow Reamer for 1.5 mm Screws |
| 28-09-20-1602 | Hollow Reamer for 2.0 mm Screws |
| 28-09-27-1602 | Hollow Reamer for 2.7 mm Screws |
| 28-09-35-1602 | Hollow Reamer for 3.5 / 4.0 mm Screws |
| 28-09-45-1602 | Hollow Reamer for 4.5 mm Screws |
| 28-09-65-1602 | Hollow Reamer for 5.0 / 6.5 / 7.0 mm Screws |

Extraction Bolts



| | |
|---------------|-----------------------------------|
| 28-09-15-1601 | Extraction Bolt for 1.5 mm Screws |
| 28-09-20-1601 | Extraction Bolt for 2.0 mm Screws |
| 28-09-27-1601 | Extraction Bolt for 2.7 mm Screws |



| | |
|---------------|---|
| 28-09-35-1601 | Extraction Bolt for 3.5 / 4.0 mm Screws |
| 28-09-45-1601 | Extraction Bolt for 4.5 mm Screws |
| 28-09-65-1601 | Extraction Bolt for 5.0 / 6.5 / 7.0 mm Screws |

Hollow Reamers Tube

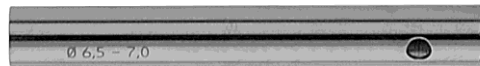

| | |
|------------------|--|
| 28-09-15-1602-03 | Speare Reamer (Reamer Tube) for Hollwow Reamer 1.5 mm (used for 1.5 mm Screws) |
| 28-09-20-1602-03 | Speare Reamer (Reamer Tube) for Hollwow Reamer 2.0 mm (used for 2.0 mm Screws) |
| 28-09-27-1602-03 | Speare Reamer (Reamer Tube) for Hollwow Reamer 2.7 mm (used for 2.7 mm Screws) |
| 28-09-35-1602-03 | Speare Reamer (Reamer Tube) for Hollwow Reamer 3.5 / 4.0 mm (used for 3.5 / 4.0 mm Screws) |
| 28-09-45-1602-03 | Speare Reamer (Reamer Tube) for Hollwow Reamer 4.5 mm (used for 4.5 mm Screws) |
| 28-09-65-1602-03 | Speare Reamer (Reamer Tube) for Hollwow Reamer 5.0 / 6.5 / 7.0 mm (used for 5.0 / 6.5 / 7.0 mm Screws) |

Hollow Reamers Centrical Bolt



| | |
|------------------|---|
| 28-09-15-1602-02 | Centrical Bolt used with Hollow Reamer for 1.5 mm |
| 28-09-20-1602-02 | Centrical Bolt used with Hollow Reamer for 2.0 mm |
| 28-09-27-1602-02 | Centrical Bolt used with Hollow Reamer for 2.7 mm |
| 28-09-35-1602-02 | Centrical Bolt used with Hollow Reamer for 3.5 / 4.0 mm |
| 28-09-45-1602-02 | Centrical Bolt used with Hollow Reamer for 4.5 mm |
| 28-09-65-1602-02 | Centrical Bolt used with Hollow Reamer for 5.0 / 6.5 / 7.0 mm |

Sharp Hook



| |
|---------------|
| 27-46-16-1800 |
| length 155 mm |

SELECTED INSTRUMENTS

T-Handle Large with AO-Quickcoupling

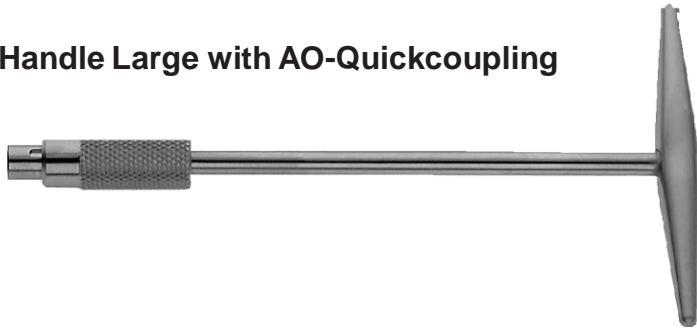

27-06-16-1600

length 160 mm

Screw Holding Forceps



27-01-21-1603

length 20,5 cm / 8"

Mini Lexer Gouge



27-21-03-00-1600

length 4 mm

Mini Lexer Gouge



27-21-03-00-1601

length 6 mm

Mini Lexer Gouge



27-21-03-00-1603

length 10 mm

Drähte - Produktlinie

Wires - product line



Kirschnerdrähte

Kirschner Wires

Material/Material

33 Werkstoff 1.4441 (Implantatstahl)/ 33 All wires are manufactured of 1.4441
34 Titan (auf Anfrage)/ 34 Titan (on request)

Durchmesser in mm: Available diameter in mm

Ø = 0,6 | 0,8 | 0,9

Ø = 1,0 | 1,1 | 1,2 | 1,3 | 1,4 | 1,5 | 1,6 | 1,7 | 1,8 | 1,9

Ø = 2,0 | 2,2 | 2,4 | 2,5 2,8

Ø = 3,0 | 3,2 | 3,5

Ø = 4,0 | 4,5 | 4,8

Ø = 5,0 | 5,5

Ø = 6,0

Kirschner Drähte Länge

Fertigen können wir Kirschner Drähte
von 5cm bis 60cm Länge.

Schleifbild je Ende



Trokarspitze (Dreikant Spitze)



Flach (Flaches Ende)



Rund (Gerundetes Ende)



Dreikant (Für Dreikant Anschluss)



Vierkant (Für Vierkant Anschluss)



Flach mit Loch (Flaches Ende mit Bohrung)



Trokar mit Gewindeansatz (Dreikant Spitze mit Gewindeansatz zB 15mm)

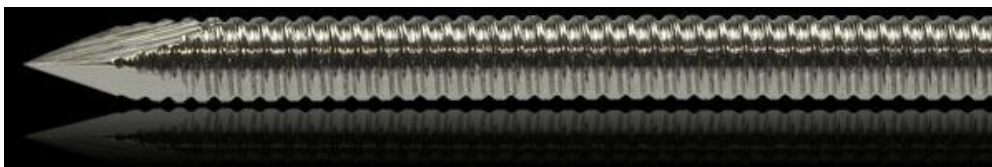

Trokar mit Vollgewinde (Dreikant Spitze mit druchgänigem Gewinde)



Lanzette (Lanzetten Spitze - Vier Flächen mit Bohrwirkung)



Lanzette mit Loch (Lanzetten Spitze mit zentrierter Bohrung)



Lanzette mit Gewindeansatz (Lanzetten Spitze mit Gewindeansatz zB 15mm)



Trokar mit Rändel (Dreikant Spitze mit Längsrändel Ansatz)



Öse (Geschlitztes Längsloch)



Bohrer (Bohrer Anschliff)

Weiter Ausführungen auf Anfrage...



















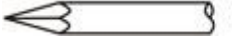
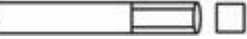



































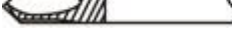

Mindestbestellmengen:

Kirschner Draht aus 1.4441: 10 Stück / je Sorte

Steinmann Nagel: 1 Stück / je Sorte

Kirschner Draht aus Titan: 1 Stück / je Sorte

Style

| | | |
|---|--|---|
| 01 Trocar / Flat |  |  |
| 02 Trocar / Round |  |  |
| 03 Trocar / Trocar |  |  |
| 04 Trocar / 3sided |  |  |
| 05 Trocar / 4sided |  |  |
| 06 Trocar / Flat with hole |  |  |
| 12 Trocar with 15mm threaded / Flat |  |  |
| 13 Trocar with 15mm threaded / Round |  |  |
| 14 Trocar with 15mm threaded - each side |  |  |
| 15 Trocar with 15mm threaded / 3sided |  |  |
| 17 Trocar / Flat - threaded full length |  |  |
| 18 Trocar / Round - threaded full length |  |  |
| 19 Trocar / Trocar - threaded full length |  |  |
| 25 Round / Round - (Hackenthal Bündelnail) |  |  |
| 31 Lancet / Flat |  |  |
| 32 Lancet / Round |  |  |
| 33 Lancet / Lancet |  |  |
| 34 Lancet / 3sided |  |  |
| 35 Lancet / 4sided |  |  |
| 36 Lancet / Flat with hole |  |  |
| 37 Lancet with hole / Round |  |  |
| 38 Lancet with hole - each side |  |  |
| 39 Lancet with hole / Trocar |  |  |
| 40 Lancet / Trocar |  |  |
| 42 Lancet with 15mm threaded - each side |  |  |
| 44 Trocar with knurled lengthwise / Round |  |  |
| 45 Trocar with knurled lengthwise / Special Eyelet |  |  |
| 46 Drill tip / Round |  |  |
| 47 Drill tip / Special Eyelet |  |  |

INHALTSVERZEICHNIS

DEUTSCH



INHALTSVERZEICHNIS DEUTSCH

| | Seite |
|------------------------------|---------------------|
| A | |
| Abortuskürette | 23 - 37 |
| Abortuslöffel | 23 - 38 |
| Abortuszange | 23 - 37; 38 |
| ADAIR Hakenzange | 23 - 17 |
| ADLERKREUTZ Pinzette | 05 - 9 |
| ADSON-CONE Wundspreizer | 15 - 7 |
| ADSON | |
| Arterienklemme | 09 - 11 |
| Elevator | 27 - 5 |
| Meißel | 27 - 5 |
| Nadelhalter | 11 - 2 |
| Pinzette | 05 - 3; 8; 20 |
| Raspatorium | 27 - 5 |
| Saugrohr | 17 - 9 |
| Wundspreizer | 15 - 2 |
| ADSON-BABY Arterienklemme | 09 - 15 |
| ADSON-BABY Wundspreizer | 15 - 2 |
| ADSON-BROWN Pinzette | 05 - 9 |
| Adventitia Mikro-Schere | 03 - 51 |
| ALAN-PARKS Analspreizer | 21 - 13 |
| ALEXANDER Flachmeißel | 27 - 9 |
| ALEXANDER Probeexzisionzange | 23 - 33 |
| ALLEN Darmklemme | 21 - 1 |
| ALLIS | |
| Atraumatische Darmfasszange | 21 - 1; 3 |
| Darmfasszange | 21 - 1; 3 |
| Gewebe Fasszange | 21 - 1; 3 |
| ALLIS-ADAIR Darmfasszange | 21 - 2 |
| ALLIS-BABY Darmfasszange | 21 - 1 |
| ALLISON Lungenspatel | 13 - 27 |
| ALLPORT Wundspreizer | 15 - 1 |
| ALM Wundspreizer | 15 - 1 |
| Aniotom | 23 - 22 |
| Amputationsmesser | 01 - 8; 10 |
| Analspreizer | 21 - 13 |
| Anatomische Pinzette | 05 - 1-5; 19; 20 |
| Anatomische Skalpelle | 01 - 7 |
| ANDERSON-ADSON Wundspreizer | 15 - 2 |
| ANDREW-PINCHON Saugrohr | 17 - 9 |
| ANTHONY Saugrohr | 17 - 9 |
| Anuskop | 21 - 14; 15 |
| Appendektomie-Wundspreizer | 15 - 4 |
| Arterienklemme | 09 - 3-22 |
| Aspirationsrohr | 17 - 8 |
| Atrauma-Bulldog Klemme | 09 - 2; 3 |
| Atrauma-Pinzette | 05 - 18 |
| Atraumische Darmklemme | 21 - 7 |
| Autopsie Messer | 01 - 9 |
| AUVARD Vaginalspekulum | 23 - 4 |
| AYRE Myommesser | 23 - 25 |

| | Seite |
|---|-------------------|
| B | |
| BABCOCK Atraumatische Darmfasszange | 21 - 4 |
| BABCOCK Darmfasszange | 21 - 4 |
| BACKHAUS Tuchklemme | 07 - 1 |
| BADGLEY Wundspreizer | 15 - 27 |
| BAGGISH Uterus-Biopsiezange | 23 - 34 |
| BAINBRIDGE Arterienklemme | 09 - 12 |
| BAKES Gallenkanal-Dilatator | 19 - 5 |
| BALFOUR Bauchdeckenhalter | 15 - 17 |
| BALFOUR Wechelvalve | 15 - 18 |
| BALFOUR-BABY Bauchdeckenhalter | 15 - 18 |
| BARRAQUER Mikro-Nadelhalter | 11 - 7 |
| BARRAQUER Nadelhalter | 11 - 21 |
| BARRAQUER-TROUTMAN Mikro-Nadelhalter | 11 - 7 |
| BARRETT Hakenzange | 23 - 17 |
| BARRY Sternal Drahtspannzange | 11 - 16 |
| Bauchdeckenhalter | 15 - 14-23 |
| Bauchdeckenhalter, Rahmen | 15 - 23 |
| Bauchdeckenhalter, Valve | 15 - 23 |
| Bauchdeckenschere | 03 - 25 |
| Bauchspatel | 15 - 25 |
| BEACHAM Aniotom | 23 - 22 |
| Beckenzirkel | 23 - 38 |
| BECKMANN Wundspreizer | 15 - 8; 9 |
| BECKMANN-ADSON Wundspreizer | 15 - 8 |
| Befestigungsgestell | 15 - 24 |
| BENGOLEA Arterienklemme | 09 - 13 |
| BERGMANN Gipsschere | 03 - 29 |
| BERGMANN Hammer | 27 - 11 |
| BERLIN Schlauchklemme | 07 - 6 |
| BERNHARD Tuchklemme | 07 - 2 |
| Beschneidungsinstrument | 19 - 10 |
| Besteck, Wundklammer- | 11 - 32 |
| BIER Lumbal-Punktionkanüle | 17 - 14 |
| Biopsiekanüle | 17 - 13; 15 |
| Biopsiekürette | 23 - 24 |
| Biopsiezange | 23 - 16; 32-34 |
| Biopsiezange, Mastdarm- | 21 - 16 |
| Biopsiezange, Uterus- | 23 - 32-34 |
| BIRKETT Präparierklemme | 9 - 10 |
| BLAKE Gallensteinzange | 19 - 2 |
| BLAKE Uteruskürette | 23 - 32 |
| Blasenspatel | 19 - 8 |
| Blasenhalsspreizer | 19 - 6 |
| BOETTCHER Tonsillen Schere | 03 - 21 |
| Bohrer, Nagel- | 25 - 1 |
| BONNEY Anatomische Pinzette | 05 - 5 |
| BONNEY Chirurgische Pinzette | 05 - 20 |
| BOYS-ALLIS Darmfasszange | 21 - 3 |

| | | | |
|--|-----------|------------------------------|--|
| BOZEMANN | | | |
| Gynäkologische Schere | 03 | - 25 | |
| Nadelhalter | 11 | - 16 | |
| Schlingendreher | 11 | - 31 | |
| Tupferzange | 07 | - 3; 4 | |
| BRAITHWAITE Dermatom | 01 | - 11 | |
| BRAITHWAITE Ersatzklinge | 01 | - 11 | |
| BRAUN | | | |
| Hakenzange | 23 | - 18; 20 | |
| Uterusdepressor | 23 | - 22 | |
| Vaginalsepekulum | 23 | - 12 | |
| BRAUN-STADLER Darmschere | 03 | - 28 | |
| BREISKY Vaginalsepekulum | 23 | - 8 | |
| BRODIE Hohlsonde | 17 | - 1 | |
| Bronchusklemme | 09 | - 22; 25 | |
| BROPHY Anatomische Pinzette | 05 | - 5 | |
| BROPHY Chirurgische Pinzette | 05 | - 11 | |
| BROPHY-SULLIVAN) Schere | 03 | - 17 | |
| BROWN Chirurgische Pinzette | 05 | - 13 | |
| BROWN Nadelhalter | 11 | - 2 | |
| BRUNNER | | | |
| Atraumatische Darmklemme | 21 | - 8 | |
| Hohlsonde | 11 | - 28 | |
| Nadel | 11 | - 25 | |
| Wundhaken | 13 | - 24 | |
| BRUNNER-FERROZELL Sonde | 11 | - 30 | |
| BRUNS | | | |
| Gipsschere | 03 | - 30 | |
| Löffel | 27 | - 1 | |
| Verbandschere | 03 | - 40 | |
| BRYANT Korn- und Tupferzange | 07 | - 3 | |
| BUCK Ligaturschere | 03 | - 19 | |
| BUELAU Trocar | 17 | - 6 | |
| Bulldog Klemme | 09 | - 1; 2; 3 | |
| Bulldog Klemme, Atrauma- | 09 | - 3; 2 | |
| Bulldog Klemme, Vene | 09 | - 2 | |
| BUMM Kürette | 23 | - 30 | |
| BUNT Sterilierklammer | 29 | - 1 | |
| BURKE Uterus-Biopsiezange | 23 | - 34 | |
| BUSCH Nabelschnurschere | 03 | - 28 | |
| BYRD Saugrohr | 17 | - 10 | |
| | | | |
| C | | | |
| CAMPBELL Hamröhrenkatheter | 19 | - 10 | |
| CAMPBELL Trocar | 17 | - 7 | |
| CANNY RYAL Wundhaken | 13 | - 12 | |
| CAPLAN Nasenschere | 03 | - 20 | |
| CARREL Arterienklemme | 09 | - 5 | |
| CASTROVIEJO Mikro-Nadelhalter | 11 | - 8 | |
| CASTROVIEJO Nadelhalter | 11 | - 21 | |
| CATLIN Amputationsmesser | 01 | - 8 | |
| CHAPUT Arterienklemme | 09 | - 3 | |
| CHEATLE Sterilisierzange | 29 | - 1 | |
| CHELSEA EATON Anuskop | 21 | - 15 | |
| | | | |
| CHERON Tupferzange | 07 | - 4 | |
| CHILDE Wundklammer Pinzette | 11 | - 32 | |
| Chirurgische Pinzette | 05 | - 5-14; 20 | |
| Chirurgische Schere | 03 | - 1-6; 11; 15-17; 31; 40; 42 | |
| | | | |
| CLAUS Unterbindungsnadel | 11 | - 27 | |
| CLAUS-EICKEN Unterbindungsnadel | 11 | - 27 | |
| CLIPS , Gefäß- | 09 | - 1 | |
| CLOWARD Modif. Valve | 15 | - 12; 13 | |
| CLOWARD Modif. Wundspreizer | 15 | - 12 | |
| COAKLEY Kieferhöhlentroc | 17 | - 7 | |
| COGSWELL Saugrohr | 17 | - 9 | |
| COHEN Intra-Uterussonde | 23 | - 14 | |
| COLLIER Nadelhalter | 11 | - 1 | |
| COLLIN | | | |
| Amputationsmesser | 01 | - 8 | |
| Bauchdeckenhalter | 15 | - 15 | |
| Fassklemme | 09 | - 3 | |
| Hammer | 27 | - 11 | |
| Operationsskalpell | 01 | - 6 | |
| Tupferzange | 07 | - 4 | |
| Uterusfasszange | 23 | - 22 | |
| Uterussonde | 23 | - 23 | |
| Vaginalsepekulum | 23 | - 1 | |
| Wundklammerzängchen | 11 | - 31 | |
| COLLIN-BABY Bauchdeckenhalter | 15 | - 14 | |
| COLLIN-DUVAL Fasspinzette | 05 | - 12 | |
| CONE Wundspreizer | 15 | - 7 | |
| COOLEY Saugrohr | 17 | - 9; 10 | |
| COOPER Unterbindungsnadel | 11 | - 24 | |
| COPPELSON Uterus-Biopsiezange | 23 | - 34 | |
| CORYKKOS Wundhaken | 13 | - 23 | |
| COTTLE Nasenschere | 03 | - 20 | |
| COUPLAND Saugrohr | 17 | - 9 | |
| COXETER Katheter | 19 | - 9 | |
| CRAFOORD Arterienklemme | 09 | - 11 | |
| CRAFOORD Lungenlappenschere | 03 | - 24 | |
| CRAFOORD-SELLORS Bronchusklemme | 09 | - 22 | |
| CRILE Arterienklemme | 09 | - 9 | |
| CRILE-MURRAY Nadelhalter | 11 | - 2 | |
| CRILE-RANKIN Arterienklemme | 09 | - 10 | |
| CRILE-WOOD Nadelhalter | 11 | - 2; 11 | |
| CUSCO Spekulum SCHWEIZER MOD. | 23 | - 2 | |
| CUSCO Vaginalsepekulum | 23 | - 1; 2 | |
| CUSHING | | | |
| Anatomische Pinzette | 05 | - 4 | |
| Chirurgische Pinzette | 05 | - 11 | |
| Nervhaken | 13 | - 4 | |
| Pinzette | 05 | - 20 | |
| Venenhaken | 13 | - 8 | |
| CUSHING-TAYLOR Pinzette | 05 | - 20 | |
| CZERNY | | | |
| Gallensteinzange | 19 | - 2 | |
| Hakenzange | 23 | - 20 | |
| Wundhaken | 13 | - 12 | |

INHALTSVERZEICHNIS DEUTSCH

D

| | |
|---------------------------------|--------------------|
| DANDY Arterienklemme | 09 - 9 |
| DANDY Neurochirurgische Schere | 03 - 18 |
| Darm-Fasszange | 21 - 1-5 |
| Darm-Klemme | 21 - 5-8; 10 |
| Darm-Pinzette | 05 - 12 |
| Darm-Quetschklemme | 21 - 9 |
| Darm-Schere | 03 - 26 |
| DARTIGUES Uterusfasszange | 23 - 21 |
| DAUBENSPECK Löffel | 27 - 2 |
| DAVIDSON Trocar | 17 - 6 |
| DAVIDSON Wundhaken | 13 - 27 |
| DE BAKEY | |
| Atrauma-Bulldog Klemme | 09 - 2 |
| Atrauma-Pinzette | 05 - 18 |
| Atraumatische Gefäßspinzette | 05 - 18 |
| Gefäßschere | 03 - 21; 23; 38 |
| Nadelhalter | 11 - 13 |
| Saugrohr | 17 - 9 |
| Wundspreizer | 15 - 9 |
| DE LA ROZA Unterbindungsnadel | 11 - 26 |
| DE LEE Geburtszange | 23 - 35 |
| DE MARTEL-WOLFSON | |
| Klemmenhalter | 21 - 9 |
| Schließzange | 21 - 9 |
| Zange | 21 - 9 |
| DEAVER Chirurgische Schere | 03 - 2 |
| DEAVER Wundhaken | 13 - 25-27 |
| Delicate Arterienklemme | 09 - 12 |
| DENNIS-BROWNE Bauchdeckenhalter | 15 - 20 |
| DEPRESSOR Uterus | 23 - 22 |
| DERF Nadelhalter | 11 - 1; 10 |
| DERF-CONVERSE Nadelhalter | 11 - 1 |
| Dermatome | 01 - 11 |
| DESCHAMPS Unterbindungsnadel | 11 - 23; 24 |
| DESJARDINS | |
| Gallenkanalklemme | 09 - 21 |
| Gallensteinlöffel | 19 - 4 |
| Gallensteinzange | 19 - 1 |
| DESMARRES Lidhalter | 13 - 7 |
| DESMARRES Wundhaken | 13 - 7 |
| DIEFFENBACH Bulldog Klemme | 09 - 1 |
| DIEFFENBACH Skalpell | 01 - 7 |
| DIETHRICH Gefäßschere | 3 - 22; 38; 39 |
| DIETHRICH Mikro-Nadelhalter | 11 - 10 |
| Dilatationskatheters | 19 - 10 |
| Dilatator, Gallenkanal- | 19 - 5 |
| Dilatator, Gefäß- | 05 - 17 |
| Dilatator, Uterus- | 23 - 16; 17 |
| DITTEL Harnröhrenkatheter | 19 - 9 |
| DIXON-LOVELACE Arterienklemme | 09 - 10 |
| DOUGLAS Trocar | 17 - 8 |

DOYEN

| | |
|--------------------------------|-------------|
| Bauchdeckenhalter | 13 - 19 |
| Bauchdeckenschere | 03 - 25 |
| Darmklemme | 21 - 5; 6 |
| Myomheber | 23 - 25 |
| Polypen- und Ovarienzange | 23 - 21 |
| Raspatorium | 27 - 6 |
| Scheidenhalter | 23 - 12 |
| Sonde | 17 - 1 |
| Vaginalspekulum | 23 - 7 |
| Wundhaken | 15 - 19; 24 |
| DOYEN-BABY Darmklemme | 21 - 5 |
| DOYEN-STILLE Wundhaken | 13 - 20 |
| Drahtschere | 03 - 29; 40 |
| Drahtzange | 11 - 16 |
| Dreiwegehahn | 17 - 16 |
| Druckklemme | 09 - 5 |
| DUBOIS Kephalotom-Schere | 03 - 26 |
| DUEHRSEN Anatomische Pinzette | 05 - 5 |
| DUEHRSEN Chirurgische Pinzette | 05 - 12 |
| DUPLAY Hakenzange | 23 - 18 |
| Dura und Hauthaken | 13 - 1 |
| Durchflusshahn | 17 - 16; 17 |
| DUVAL Darmfasszange | 21 - 4; 5 |
| DUVAL Dampinzette | 05 - 12 |

E

| | |
|---------------------------------|-------------|
| Einlagesieb | 23 - 15 |
| Einmal Skalpell | 01 - 3; 4 |
| EISELSBERG Ligaturschere | 03 - 18 |
| Elevator | 27 - 4 |
| ELLIOT Geburtszange | 23 - 36 |
| EMMET Fistelhaken | 23 - 25 |
| Endarterektomie Präparierschere | 03 - 42 |
| Endospekulum | 23 - 13 |
| ENGL. MOD. Tuckklemme | 07 - 1 |
| Episiotomie-Schere | 03 - 27; 28 |
| EPPENDORF Uterus-Biopsiezange | 23 - 33 |
| Ersatzklinge | 01 - 11 |
| ESMARCH Verbandschere | 03 - 30 |
| Etui | 23 - 15; 16 |

F

| | |
|-------------------------|-------------|
| Fadenfänger | 11 - 31 |
| Fadengabel | 11 - 31 |
| FALK Unterbindungsnadel | 11 - 27 |
| FARABEUF Raspatorium | 27 - 5 |
| FARABEUF Wundhaken | 13 - 10 |
| FARREL Wattenträger | 17 - 3 |
| Fassklemme | 09 - 3 |
| Fasspinzette | 05 - 5; 12 |
| Fasszange, Uterus- | 23 - 21; 22 |
| FAURE Peritoneumklemme | 09 - 26 |

| | |
|------------------------------------|---------------------------|
| FAURE Uterus-Biopsiezange | 23 - 32 |
| FAVALORO Gefäßschere | 03 - 23 |
| Federschraubkappe | 17 - 16 |
| FEILCHENFELD Splitter-Pinzette | 05 - 15 |
| Fein Watteträger | 17 - 3 |
| Fein Chirurgische Pinzette | 05 - 7 |
| Fein Chirurgische Schere | 03 - 15; 16; 40; 42 |
| Fein Präparierschere | 03 - 44 |
| Fein Schere | 03 - 14-16; 40; 42; 44 |
| Fein Wundhaken | 13 - 1; 2 |
| FERGUSSON | |
| Chirurgische Schere | 03 - 17 |
| Druckklemme | 09 - 5 |
| Gallensteinlöffel | 19 - 3 |
| Saugrohr | 17 - 11 |
| FERRIS-SMITH Chirurgische Pinzette | 05 - 5;13 |
| Fingerringssäge | 25 - 3 |
| FINOCCHIETTO | |
| Arterienklemme | 09 - 22 |
| Nadelhalter | 11 - 4; 15 |
| Lungenlappenschere | 03 - 27 |
| Rippensperrerr | 15 - 26 |
| FINOCCHIETTO-BABY Rippensperrerr | 15 - 26 |
| FINSEN Wundspreizer | 15 - 1 |
| Fistelhaken | 21 - 17; 23 - 25 |
| Flachmeißel | 27 - 7-9 |
| FOERSTER Schwammzange | 07 - 5 |
| FOERSTER-BALLENGER Schwammzange | 07 - 5 |
| FOMON Nasenschere | 03 - 19; 44 |
| FOMON Präparierschere | 03 - 6 |
| FOX Hautkürette | 25 - 2 |
| FRANZ | |
| Bauchdeckenhalter | 15 - 23 |
| Bauchdeckenhalter Rahmen | 15 - 23 |
| Bauchdeckenhalter Valve | 15 - 23 |
| Dura und Hauthaken | 13 - 1 |
| Saugkanüle | 17 - 11 |
| Fremdkörperzange | 19 - 7 |
| FRITSCH Wundhaken | 13 - 19 |
| Führungshohlsonde | 11 - 29; 30 |
| G | |
| Gabel, Faden- | 11 - 31 |
| Gallenkanaldilatator | 19 - 5 |
| Gallenkanalklemme | 09 - 14; 21; 22 |
| Gallensteinlöffel | 19 - 3; 4 |
| Gallensteinsonde | 19 - 3; 4 |
| Gallensteinzange | 19 - 1; 2 |
| GARLAND Klemmzange | 09 - 28 |
| Gaumennadel | 11 - 27 |
| Geburtszange | 23 - 35; 36 |
| Gefäßklemme | 09 - 1 |

| | |
|-------------------------------------|---------------------------|
| Gefäßdilatoren | 05 - 17 |
| Gefäßpinzette, Atraumatisch | 05 - 18 |
| Gefäßschere | 03 - 20-24; 38; 39; 44 |
| GELPI Wundspreizer | 15 - 7 |
| GELPI-LOKTITE Wundspreizer | 15 - 7 |
| GEMINI Präparier- und Ligaturklemme | 09 - 19 |
| GERALD Anatomische Pinzette | 05 - 3, 4, 20 |
| GERALD Chirurgische Pinzette | 05 - 20 |
| Gestell, Befestigungs- | 15 - 24 |
| Gewebefasszange | 21 - 2, 3 |
| GILLIES | |
| Chirurgische Pinzette | 05 - 9; 20 |
| Hauthaken | 13 - 1 |
| Nadelhalter/Schere | 11 - 17 |
| GIL-VERNET Wundhaken | 13 - 9 |
| Gipsschere | 03 - 29; 30 |
| GLASSMAN Darmklemme | 21 - 8 |
| GLOVER Atrauma-Bulldog Klemme | 09 - 3 |
| GÖLET Wundhaken | 13 - 12 |
| GOMEL Mikro-Nadelhalter | 11 - 7 |
| GOOD Tonsillen Schere | 03 - 21 |
| GOSSET Bauchdeckenhalter | 15 - 16 |
| GRAEFE Feiner Wundhaken | 13 - 1 |
| GRAEFE-IRIS Pinzette | 05 - 16; 17 |
| GRAVE Vaginalspekulum | 23 - 3 |
| GRAY Gallenkanalklemme | 09 - 22 |
| GREEN-ARMYTAGE Uterusklemmzange | 23 - 37 |
| Griff, Skalpell- | 01 - 1; 2 |
| GROSS-MAIER Kornzange | 07 - 5 |
| GUTHRIE Feiner Wundhaken | 13 - 2 |
| GUYON | |
| Katheter | 19 - 10 |
| Dilatationskatheters | 19 - 10 |
| Nierensteinklemme | 09 - 23 |
| Gynäkologische Schere | 03 - 11; 24; 25; 37 |
| HABERER Bauchspatel | 15 - 25 |
| Hahn, Dreiwege- | 17 - 16 |
| Hahn, Durchfluss- | 17 - 16; 17 |
| HAIGHT Rippensperrerr | 15 - 27 |
| Häkchen, Haut- | 13 - 1 |
| Häkchen, Tränensack- | 13 - 3 |
| Haken, | |
| Bauchdecken- | 15 - 24 |
| Dura und Haut- | 13 - 1 |
| Fistel- | 21 - 17 |
| Fistel- | 23 - 25 |
| Haut- | 13 - 1 |
| Hüftgelenk- | 13 - 14 |
| Nerv- | 13 - 4 |
| Prostata- | 19 - 8 |
| Tracheal- | 13 - 3; 4 |
| Venen- | 13 - 8 |
| Wund- | 13 - 1-27 |
| Zängchen- | 23 - 17-20 |

INHALTSVERZEICHNIS DEUTSCH

| | | | |
|---------------------------------|---------------|--------------------------------------|-------------|
| HALLE Nasenschere | 03 - 19 | HOSEMANN Arterienklemme | 09 - 21 |
| HALLE Löffel | 27 - 2 | Hüftgelenkhaken | 13 - 14 |
| HALSEY Nadelhalter | 11 - 1 | HUMBY Dermatom | 01 - 11 |
| HALSTED Arterienklemme | 09 - 7 | HUNTER Splitterpinzette | 05 - 15 |
| HALSTED-MOSQUITO Arterienklemme | 09 - 7 | HURD Gaumennadel | 11 - 27 |
| Halter, Bauchdecken- | 15 - 14-23 | HURWITZ Trocar | 17 - 5 |
| Halter, Klemmen- | 21 - 9 | Hysterektomie Klemme | 09 - 27 |
| Halter, Lid- | 13 - 7 | Hysterektomie Präparierschere | 03 - 36 |
| Halter, Nadel- | 11 - 4 | | |
| Halter, Scheiden- | 23 - 5 | I | |
| Haltevorrichtung | 15 - 24 | Instrumenten-Etui | 11 - 32 |
| Hammer | 27 - 8; 11 | Instrumentenfasspinzette | 29 - 1 |
| Hämorrhoiden Ligatoren | 21 - 16 | Instrumentenkasten | 29 - 3 |
| Hämorrhoiden Zange | 23 - 21 | Insufflationskanüle VERESS | 17 - 13 |
| Hämorrhoiden Klemme | 09 - 4; 5 | Intra-Uterussonde | 23 - 14 |
| Hämorrhoiden Fasszange | 21 - 17 | Inzisionschere | 03 - 17 |
| Handgriff | 17 - 4 | IOWA Hakenzange | 23 - 20 |
| HANK Uterus-Dilatator | 23 - 16 | IOWA Kanüle | 17 - 12 |
| Harnröhrenkatheter | 19 - 9 | IRIS | |
| HARRINGTON Wundhaken | 13 - 23 | Feine Chirurgische Schere | 03 - 15; 40 |
| HARTMANN Arterienklemme | 09 - 6 | Schere | 03 - 15; 43 |
| Hauthäkchen | 13 - 1 | Pinzette | 05 - 16; 17 |
| Hauthaken | 13 - 1 | ISRAEL Wundhaken | 13 - 14 |
| Hautkürette | 25 - 1; 2 | IVES FANSLER Anuskop | 21 - 15 |
| Hautstanze | 25 - 1 | | |
| HAYES Rektum-Anastomosenklemme | 21 - 11 | J | |
| HEANEY Klemmzange | 09 - 29 | JABALEY Feine Chirurgische Schere | 03 - 42 |
| HEANEY Nadelhalter | 11 - 4 | JACKSON BURROWS Wundspreizer | 15 - 10 |
| HEANEY-BALLANTINE Klemmzange | 09 - 28 | JACKSON Vaginalspekulum | 23 - 9 |
| HEANEY-KANTER Klemmzange | 09 - 28 | JACOBI Unterbindungsnadel | 11 - 26 |
| Heber, Myom- | 23 - 25 | JACOBS Hakenzange | 23 - 19 |
| HEGAR Nadelhalter | 11 - 16 | JAMISON Nadelhalter | 11 - 4 |
| HEGAR Uterusdilatator | 23 - 15; 16 | JAMISON Präparierschere | 03 - 42 |
| HEGAR-BAUMGARTNER Nadelhalter | 11 - 1; 10 | JANSEN Löffel | 27 - 3 |
| HEGEMANN Gefäßschere | 03 - 44 | JANSEN Wundspreizer | 15 - 1 |
| HEGEMANN-DIETHRICH Gefäßschere | 03 - 22 | JARCHO Hakenzange | 23 - 18 |
| HEGENBARTH Wundklammer Pinzette | 11 - 31 | JOBSON-HORNE Watteträger | 17 - 3 |
| HEISS Arterienklemme | 09 - 14 | JOHNS-HOPKINS Arterienklemme | 09 - 15 |
| HENLEY Wechselvalve | 15 - 11 | JOHNS-HOPKINS Bulldog Klemme | 09 - 1 |
| HENLEY Wundspreizer | 15 - 11 | JOHNSON Nadelhalter | 11 - 4 |
| HEPP SCHEIDEL | | JOLL (FRIEDMAN) Vaginal-Wundspreizer | 15 - 10 |
| Mikro-Nadelhalter | 11 - 20 | JONES Tuchklemme | 07 - 1 |
| Mikro-Schere | 3 - 45 | JOSEPH | |
| Saugrohr | 17 - 10 | Hauthäkchen | 13 - 1 |
| HERRICK Nierensteinklemme | 09 - 24 | Feiner Wundhaken | 13 - 2 |
| HESS Bulldog Klemme | 09 - 1 | Schere | 03 - 13 |
| HESSBERG Unterbindungsnadel | 11 - 26 | JUDD-ALLIS Darmfasszange | 21 - 2 |
| HEYMANN Nasenschere | 03 - 20 | JUDD-MASON Blasenwundspreizer | 19 - 6 |
| HEYMANN Tonsillenschere | 03 - 20 | | |
| HEYWOOD-SMITH Hämorrhoidenzange | 23 - 21 | K | |
| Hirmmesser | 01 - 9 | KAHN Hakenzange | 23 - 18 |
| HIRSCHMANN Anuskop | 21 - 14 | KALLMORGEN Vaginalspekulum | 23 - 9 |
| Hohlmeißel | 27 - 7-10 | KALT Mikro-Nadelhalter | 11 - 10 |
| Hohlsonde | 17 - 1; 2; 28 | Kaltlichtträger | 21 - 15 |

| | |
|---------------------------------------|-----------------|
| KANTROWITZ Präparierklemme | 09 - 19 |
| Kanüle, | |
| Biopsie- | 17 - 12-14 |
| Insufflations- | 17 - 13 |
| Lumbal-Punktions- | 17 - 14 |
| Punktions- | 17 - 15 |
| Saug- | 17 - 11 |
| Spezial- | 17 - 12 |
| Spül- | 17 - 12 |
| Sternal-Punktion- | 17 - 12 |
| Katheter | 19 - 9; 10 |
| KAYE Face Lift Präparierschere | 03 - 41 |
| KELLY | |
| Arterienklemme | 09 - 8 |
| Fistelschere | 03 - 26 |
| Polypenzange | 23 - 21 |
| Präparier- und Ligaturklemme | 09 - 18 |
| Proktoskop | 21 - 14 |
| Sphinkterskop | 21 - 14 |
| Wundhaken | 13 - 18; 21 |
| KELLY-RANKIN Arterienklemme | 09 - 8 |
| Kephalotom-Schere | 03 - 26 |
| Kette mit Gewicht | 15 - 24 |
| KEVORKIAN Biopsiekürette | 23 - 24 |
| KEVORKIAN-PACIFIC Uterus-Biopsiezange | 23 - 34 |
| KEVORKIAN-YOUNGE Biopsiezange | 23 - 33 |
| KEYES Hautstanze | 25 - 1 |
| Kieferhöhlentrocar | 17 - 7 |
| KIELLAND Geburtszange | 23 - 36 |
| KILNER | |
| Feine Präparierschere | 03 - 44 |
| Hauthaken | 13 - 1 |
| Nadelhalter | 11 - 11 |
| Schere | 03 - 12 |
| KIRSCHNER Bauchdeckenhalter | 15 - 21; 22 |
| KIRSCHNER Führungshohlsonde | 11 - 30 |
| Klammer, Wund- | 11 - 32 |
| Klammer, Sterilisier- | 29 - 1 |
| KLEINERT-KUTZ Wund- und Hauthäkchen | 13 - 1 |
| Klemme, | |
| Arterien- | 09 - 3-26 |
| Atrauma-Bulldog- | 09 - 3 |
| Bronchus- | 09 - 22; 25 |
| Bulldog | 09 - 1 |
| Darm- | 21 - 1-8; 10 |
| Darmquetsch- | 21 - 9 |
| Druck- | 09 - 5 |
| Fass- | 09 - 3 |
| Gallenkanal- | 09 - 14; 21; 22 |
| Halter- | 21 - 9 |
| Hämorrhoiden- | 09 - 4; 5 |
| Hysterektomie- | 09 - 27 |
| Kopfhaut- | 09 - 4 |
| Magen- | 21 - 10 |
| Magenquetsch- | 21 - 9 |

| | |
|--|---------------------------------|
| Klemme, | |
| Nierenstiel- | 09 - 23; 24 |
| Peritoneum- | 09 - 25; 26 |
| Präparier- | 09 - 6; 10; 16; 18-20; 22 |
| Rektum-Anastomosen | 21 - 11 |
| Schlauch- | 07 - 6 |
| Tuch- | 07 - 1; 2; 3 |
| Uro-Tangential- | 09 - 24 |
| Vene- | 09 - 2 |
| Klemmzange | 09 - 26-29 |
| KLIMA-ROSSEGGER Sternal-Punktionkanüle | 17 - 12 |
| Klingen, Skalpell- | 01 - 5 |
| KLINKENBERGH-LOTH Gefäßschere | 03 - 24 |
| KNAPP Tränensackhäkchen | 13 - 3 |
| Knopfsonde | 11 - 30; 17 - 1 |
| Knorpelschere | 03 - 21; 24 |
| KNOWLES Schere | 03 - 30 |
| KOCHER | |
| Atraumatische Darmklemme | 21 - 7 |
| Blasenspatel | 19 - 8 |
| Darmklemme | 21 - 6 |
| Knopfsonde | 11 - 30 |
| Unterbindungsnadel | 11 - 25 |
| Wundhaken | 13 - 13; 17; 20 |
| KOCHER Delicate Arterienklemme | 09 - 12 |
| KOCHER-LANGENBECK Wundhaken | 13 - 16 |
| KOERTE Wundhaken | 13 - 14 |
| KOGAN Endospekulum | 23 - 13 |
| Komedonenquetscher | 25 - 2 |
| KÖNIG Führungshohlsonde | 11 - 29 |
| KÖNIG Raspatorium | 27 - 5 |
| Konus | 23 - 14 |
| Kopfklemme | 09 - 4 |
| Kornzange | 07 - 4; 5 |
| Krampfader-Besteck | 17 - 4 |
| KRAUSE Trocar | 17 - 8 |
| KRISTELLER Vaginalsepekulum | 23 - 5; 9 |
| KROENLEIN Arterienklemme | 09 - 5 |
| KRONECKER Unterbindungsnadel | 11 - 26 |
| Kürette, Abortus- | 23 - 37 |
| Kürette, Biopsie- | 23 - 24 |
| Kürette, Haut- | 25 - 1; 2 |
| Kürette, Saug- | 23 - 24 |
| Kürette, Uterus- | 23 - 27; 29; 32 |
| L | |
| Lagersieb | 23 - 16 |
| LAHEY Gallenkanalklemme | 09 - 21 |
| LAHEY Wundhaken | 13 - 20 |

INHALTSVERZEICHNIS DEUTSCH

| | | | |
|---|--|------------------------|--|
| LAMBOTTE | | | |
| Osteotom | | 27 - 11 | |
| Osteotom, mini | | 27 - 11 | |
| Raspatorium | | 27 - 5 | |
| LANDAU Trocar | | 17 - 6 | |
| LANDAU Vaginalsepekulum | | 23 - 11 | |
| LANDOLT Feine Schere | | 03 - 14 | |
| LANE | | | |
| Chirurgische Pinzette | | 05 - 13; 14 | |
| Darm- und Gewebefasszange | | 21 - 2 | |
| Magenklemme | | 21 - 10 | |
| Tuchklemme | | 07 - 2 | |
| LANGE Wundklammer Pinzette | | 11 - 32 | |
| LANGENBECK | | | |
| Amputationsmesser | | 01 - 9 | |
| Elevator | | 27 - 4 | |
| Hüftgelenkhaken | | 13 - 14 | |
| Nadelhalter | | 11 - 20 | |
| Raspatorium | | 27 - 6 | |
| Wundhaken | | 13 - 15 | |
| Wundhaken, mini | | 13 - 5 | |
| LANGENBECK-GREEN Wundhaken | | 13 - 4 | |
| LAWRENCE Arterienklemme | | 09 - 21 | |
| LAWRENCE Nadelhalter | | 11 - 3 | |
| LEGUEU Blasenspatel | | 19 - 8 | |
| LEGUEU Blasenwundsperrerr | | 19 - 6 | |
| LEMPERT Löffel | | 27 - 2 | |
| LERICHE Arterienklemme | | 09 - 9 | |
| LERMOYEZ Trocar | | 17 - 7 | |
| LEXER Präparierschere | | 03 - 11 | |
| LEXER Schere | | 03 - 32 | |
| LEXER-BABY Präparierschere | | 03 - 11 | |
| LICHTENBERG Nadelhalter | | 11 - 6, 19 | |
| LICHTWITZ Trocar | | 17 - 8 | |
| Lidhalter | | 13 - 7 | |
| Ligator, Hämorrhoidal- | | 21 - 16 | |
| Ligaturklemme | | 09 - 15; 18; 19; 22 | |
| Ligaturschere | | 03 - 18; 19 | |
| LINCOLN Gefäßschere | | 03 - 20 | |
| LISTER Tupferzange | | 07 - 3 | |
| LISTER Verbandschere | | 03 - 29; 40 | |
| LISTON Amputationsmesser | | 01 - 8 | |
| LITTAUER Ligaturschere | | 03 - 19 | |
| LITTLE Wundhaken | | 13 - 21 | |
| LITTLE-WOOD Darm- und Gewebefasszange | | 21 - 2 | |
| LLOYD-DAVIES Darmschere | | 03 - 26 | |
| LOCKHART-MUMMERY Sonde | | 17 - 2 | |
| LOCKWOOD Darm- und Gewebefasszange | | 21 - 3 | |
| Löffel, Abortus- | | 27 - 38 | |
| Löffel, Gallenstein- | | 19 - 3; 4 | |
| Löffel, Uterus- | | 23 - 32 | |
| LONG Klemmzange | | 09 - 28 | |
| LORENZ Verbandschere | | 03 - 30 | |
| LORNA Tuchklemme | | 07 - 2 | |
| LOVELACE Lungenfasszange | | 09 - 24 | |
| LOWER Arterienklemme | | 09 - 21 | |
| LUER-KOERTE Gallensteinlöffel | | 19 - 3 | |
| LUER-LOCK Spezial Kanüle | | 17 - 12 | |
| LUMBAL Punktionkanüle | | 17 - 14; 15 | |
| Lungenfasszange | | 09 - 24 | |
| Lungenlappenschere | | 03 - 24; 27 | |
| Lungenspatel | | 13 - 27 | |
| M | | | |
| M.G.H. Nadelhalter | | 11 - 2 | |
| Magenklemme | | 21 - 10 | |
| Magenquetschklemme | | 21 - 9 | |
| MAGILL Mandrin | | 17 - 10 | |
| MAGILL Saugrohr | | 17 - 10 | |
| MAINGOT Hysterektomieklammer | | 09 - 27 | |
| MARTEL Kopfhautklemme | | 09 - 4 | |
| MARTIN | | | |
| Beckenzirkel | | 23 - 38 | |
| Uterussonde | | 23 - 23 | |
| Löffel | | 27 - 3 | |
| MASSON Nadelhalter | | 11 - 4, 15 | |
| Mastdarm-Biopsiezange | | 21 - 16 | |
| Mastdarm-Spekulum | | 21 - 12 | |
| MATHIEU | | | |
| Fremdkörperzange | | 19 - 7 | |
| Mastdarm-Spekulum | | 21 - 12 | |
| Nadelhalter | | 11 - 6; 18; 19 | |
| Vaginalsepekulum | | 23 - 11 | |
| Wundhaken | | 13 - 11 | |
| MATHIEU-KOCHER Nadelhalter | | 11 - 7; 18 | |
| MATZENAUER Vaginalsepekulum | | 23 - 12 | |
| MAYO | | | |
| Chirurgische Schere | | 03 - 5 | |
| Gallensteinlöffel | | 19 - 3 | |
| Gallensteinsonde | | 19 - 4 | |
| Schere | | 03 - 5; 32; 41 | |
| Sterilisierklammer | | 29 - 1 | |
| Uterus Schere | | 03 - 5 | |
| MAYO-ADAMS Appendektomie- Wundspreizer | | 15 - 4 | |
| MAYO-BLAKE Gallensteinzange | | 19 - 1 | |
| MAYO-HEGAR Nadelhalter | | 11 - 3; 12 | |
| MAYO-HEGAR Delicate Nadelhalter | | 11 - 3 | |
| MAYO-NOBLE Chirurgische Schere | | 03 - 6 | |
| MAYO-ROBSON Atraumatische Darmklemme | | 21 - 7 | |
| MAYO-ROBSON Darmklemme | | 21 - 7 | |
| MAYO-STILLE Chirurgische Schere | | 03 - 6 | |
| MAYO-STILLE Schere | | 03 - 32 | |
| MC DONALD Elevator | | 27 - 4 | |
| MC GIVNEY Hämorrhoidal Fasszange | | 21 - 17 | |
| MC GIVNEY Hämorrhoidal Ligator | | 21 - 16 | |

| | |
|----------------------------------|--------------------------|
| MC INDOE | |
| Anatomische Pinzette | 05 - 3; 20 |
| Chirurgische Pinzette | 05 - 10 |
| Knorpelschere | 03 - 24 |
| MC QUIGG-MIXTER Präparierklemme | 09 - 22 |
| MEEKER Arterienklemme | 09 - 20 |
| Meißel, Flach- | 27 - 7; 8 |
| Meißel, Hohl- | 27 - 7-10 |
| MENGHINI Biopsie-Kanüle | 17 - 15 |
| Messer, Amputations- | 01 - 8-10 |
| Messer, Autopsie- | 01 - 9 |
| Messer, Hirn- | 01 - 9 |
| Messer, Myom- | 23 - 25 |
| Messer, Resektions- | 01 - 10 |
| Metall-Etui | 23 - 15; 16 |
| Metall-Katheter | 19 - 9 |
| METZENBAUM | |
| Delicate Schere | 03 - 9 |
| Nadelhalter | 11 - 2 |
| Schere | 03 - 7; 8; 33; 34; 41 |
| METZENBAUM-BABY | |
| Chirurgische Schere | 03 - 43 |
| Präparierschere | 03 - 43 |
| Schere | 03 - 7 |
| METZENBAUM-FINO Präparierschere | 03 - 10; 34-36; 41 |
| METZENBAUM-LAHEY Präparierschere | 03 - 10 |
| METZENBAUM-NELSON Schere | 03 - 7; 8; 41 |
| MEYERDING Wundhaken | 13 - 5; 24 |
| MICHEL | |
| Wundklammer | 11 - 32 |
| Wundklammer Besteck | 11 - 32 |
| Wundklammer Pinzette | 11 - 32 |
| Wundklammerzängchen | 11 - 31 |
| MIDDELDORPF Wundhaken | 13 - 18; 19 |
| Mikro-ADSON | |
| Anatomische Pinzette | 05 - 3 |
| Chirurgische Pinzette | 05 - 8 |
| Präparierpinzette | 09 - 15 |
| Mikro-MOSQUITO Arterienklemme | 09 - 8 |
| Mikro-Nadelhalter | 11 - 7; 8-10; 20 |
| Mikro-Pinzette | 05 - 15 |
| Mikro-Präparierschere | 03 - 46 |
| Mikro-RYDER Nadelhalter | 11 - 13 |
| Mikro-Schere | 03 - 8; 45-47; 51 |
| MIKULICZ | |
| Peritoneumklemme | 09 - 25 |
| Rektum-Anastomosenklemme | 21 - 11 |
| Wundhaken | 13 - 22 |
| MIKULICZ-BABY Peritoneumklemme | 09 - 25 |
| MILAN Biopsiekürette | 23 - 24 |
| MILLIGAN Wundspreizer | 15 - 6 |

| | |
|---|--------------------|
| MILLIN | |
| Blasenhalsperrer | 19 - 7 |
| Blasenwundsperrer | 19 - 7 |
| Fadenführungszange | 19 - 7 |
| Fasszange | 19 - 7 |
| Kapselasszange | 19 - 7 |
| MIXTER | |
| Arterienklemme | 09 - 20 |
| Chirurgische und Gynäkologische Schere | 03 - 11 |
| Gallensteinzange | 19 - 1 |
| MIXTER-BABY Arterienklemme | 09 - 6 |
| MIXTER-BABY Präparierklemme | 09 - 15 |
| MOCK Spül Kanüle | 17 - 12 |
| MOD. BONN Schere | 03 - 16 |
| MOD. ERLANGEN Uterus Perforator | 23 - 25 |
| MOD. USA Schere | 03 - 28 |
| MOD. USA Chirurgische Pinzette | 05 - 8 |
| MOD. WIEN Fadenfänger | 11 - 31 |
| MOLLISON Wundspreizer | 15 - 3 |
| MOORE Gallensteinlöffel | 19 - 4 |
| MORGAN Proktoskop | 21 - 15 |
| MORRIS Wundhaken | 13 - 22 |
| MOYNIHAN Gallensteinsonde und Löffel | 19 - 3 |
| MOYNIHAN Hysterektomieklammer | 09 - 27 |
| MUSEUX Hakenzange | 23 - 20 |
| Myomheber | 23 - 25 |
| Myommesser | 23 - 25 |
| Myrtelblattsonde | 17 - 1 |
| N | |
| NABATOFF | |
| Handgriff | 17 - 4 |
| Krampffader-Besteck | 17 - 4 |
| Kunststoffspitze | 17 - 4 |
| Metall-Etui | 17 - 4 |
| Metall-Sonden Spitze | 17 - 4 |
| Olive | 17 - 4 |
| Zugseil | 17 - 4 |
| Nabelschnurschere | 03 - 28 |
| Nadel, Gaumen- | 11 - 15; 22-27 |
| Nadel, Unterbindungs- | 11 - 23-27 |
| Nadelausreißzange | 25 - 3 |
| Nadelbohrer | 25 - 1 |
| Nadeldose | 29 - 3 |
| Nadelhalter | 11 - 1-21 |
| Nadelhalter/Schere | 11 - 5 |
| NAEGELE Geburtszange | 23 - 36 |
| Nagel-Zwickzange | 25 - 3 |
| NAGER Unterbindungs-nadel | 11 - 27 |
| Nasenschere | 03 - 19; 20; 44 |
| NEGUS Gallenkanalklemme | 09 - 14 |
| NEIVERT Nadelhalter | 11 - 1 |

INHALTSVERZEICHNIS DEUTSCH

| | | | |
|----------------------------------|----------------------|---------------------------------------|---------------------------------------|
| NELATON Sonde | 17 - 1 | Perforator | 23 - 25 |
| NELSON Fasspinzette | 05 - 12 | Peritoneumklemme | 09 - 25; 26 |
| NELSON Trocar | 17 - 7 | PESTALOZZA Abortuskürette | 23 - 37 |
| Nervhaken | 13 - 4 | PHANEUF Klemme | 09 - 26 |
| Nerv-Präparierschere | 03 - 13 | PIERCE Oberkiefertrocar | 17 - 7 |
| Neurochirurgische Schere | 03 - 18 | PIFFARD Hautkürette | 25 - 1 |
| Nierenschale | 29 - 2 | Pinzette, | |
| Nierensteinzange | 19 - 1 | Anatomische | 05 - 1-5; 18-20 |
| Nierensteinklemme | 09 - 23; 24 | Atrauma- | 05 - 18 |
| NORFOLK-NORWICH Wundspreizer | 15 - 10 | Chirurgische | 05 - 5-14 |
| NORTHBENT Ligaturschere | 03 - 18 | Darmfass- | 05 - 12 |
| NOTO Polypenzange | 23 - 21 | Gefäß- | 05 - 18 |
| NOVAK Saugkürette | 23 - 24 | Instrumentenfass- | 29 - 1 |
| O | | IRIS | 05 - 16; 17 |
| Oberkiefertrocar | 17 - 7 | Mikro- | 05 - 15 |
| OCHSNER Gallensteinsonde | 19 - 4 | Splitter- | 05 - 14; 15 |
| OCHSNER Trocar | 17 - 7 | Uhrmacher- | 05 - 17 |
| OCHSNER-KOCHER Arterienklemme | 09 - 13 | Wundklammer- | 11 - 31; 32 |
| O'CONNOR Feiner Wundhaken | 13 - 1 | PIPER Geburtszange | 23 - 36 |
| Ohr Sonde | 17 - 1 | Plazentarzange | 23 - 38 |
| Olive | 17 - 4; 9 | PLESTER Wundspreizer | 15 - 6 |
| OLSEN-HEGAR Nadelhalter / Schere | 11 - 5 | Polypenzange | 23 - 21 |
| Operationsskalpell | 01 - 6 | POOLE Aspirationsrohr | 17 - 8 |
| Osteotom | 27 - 7; 8; 10; 11 | POPPE (FERGUSSON) Saugrohr | 17 - 11 |
| O'SULLIVAN-O'CONNOR | 15 - 20 | POTTS DE MARTEL Gefäßschere | 03 - 38 |
| Bauchdeckenhalter | | POTTS-SMITH | |
| O'SULLIVAN-O'CONNOR Rahmen | 15 - 20 | Anatomische Pinzette | 05 - 4; 20 |
| Ovarienzange | 23 - 21 | Chirurgische Pinzette | 05 - 11 |
| OVERHOLT-BABY Arterienklemme | 09 - 9 | Gefäßschere | 03 - 23; 39 |
| OVERHOLT-GEISSENDOERFER Klemme | 09 - 17 | Schere | 03 - 27 |
| OVERHOLT-MIXTER Klemme | 09 - 15 | POZZI | |
| P | | Hakenzange | 23 - 18 |
| Paparell Schere | 03 - 16 | Präparier-Klemme | 09 - 6; 10; 16; 18-20 |
| PARKER Wundhaken | 13 - 11 | Präparier-Mikro-Schere | 03 - 46 |
| PARKER-LANGENBECK Wundhaken | 13 - 12 | Präparier-Ligatur Klemme | 09 - 15; 18; 19; 22 |
| PARTSCH | | Präparier-Schere | 03 - 6; 10-13; 17; 34-36; 41-44 |
| Flachmeißel | 27 - 7 | PRATT | |
| Hammer | 27 - 8; 11 | Fistelhaken | 21 - 17 |
| Hohlmeißel | 27 - 8 | Hakenzange | 23 - 20 |
| PAYR | | Hämorrhoidenklemmen | 09 - 5 |
| Darmquetschklemme | 21 - 9 | Uterus-Dilatator | 23 - 17 |
| Führungshohlsonde | 11 - 29 | PRESBYTERIAN Schlauchklemme | 07 - 6 |
| Magenquetschklemme | 21 - 9 | PRICE-THOMAS Klemme | 09 - 25 |
| PAYR-BABY Darmquetschklemme | 21 - 9 | PRINCE Tonsillenschere | 03 - 21 |
| PEAN Arterienklemme | 09 - 6 | Probeexzisionzange | 23 - 32; 33 |
| PEAN Delicate Arterienklemme | 09 - 12 | Proktoskope | 21 - 14; 15 |
| PEDERSON Vaginalspekulum | 23 - 3 | Prostatahaken | 19 - 8 |
| PEERS Tuchklemme | 07 - 3 | PROVIDENCE-HOSPITAL Arterienklemme | 09 - 7 |
| PELKMANN Tupferzange | 07 - 4 | Punktionkanüle | 17 - 12; 14; 15 |
| Penisklemme | 19 - 10 | PYE-SMITH (HARRISON) Sterilisierzange | 29 - 1 |
| PENNINGTON Arterienklemme | 09 - 4 | QUINKE Lumbal-Punktionkanüle | 17 - 15 |

R

| | |
|-----------------------------------|-----------------|
| RADOLF Nadelausreißzange | 25 - 3 |
| RAGNELL Wundhaken | 13 - 6 |
| RAGNELL-DAVIS Wundhaken | 13 - 6 |
| Rahmen | 15 - 20 |
| Rahmen, Bauchdeckenhalter- | 15 - 23 |
| RAMPLEY Schwammzange | 07 - 5 |
| RANDALL Nierensteinzange | 19 - 1 |
| RANDALL Saugkürette | 23 - 24 |
| Raspatorium | 27 - 4-6 |
| RECAMIER Kürette | 23 - 26; 28 |
| Rektum-Anastomosenklemme | 21 - 11 |
| Rektumschere | 03 - 27 |
| Rektumspreizer | 21 - 12 |
| Resektionsmesser | 01 - 10 |
| Retraktor | 15 - 19 |
| REVERDIN Bauchspatel | 15 - 25 |
| REVERDIN Nadel | 11 - 22 |
| REYNOLDS Präparierschere | 03 - 12; 36; 43 |
| RICARD Bauchdeckenhalter | 15 - 14 |
| RICHARDSON Wundhaken | 13 - 18 |
| RICHARDSON-EASTMAN Wundhaken | 13 - 19 |
| RICHTER Wundsperrerr | 15 - 10 |
| RICHTER-HEATH Wundklammerzängchen | 11 - 31 |
| Rippensperrerr | 15 - 26; 27 |
| ROBERTS Arterienklemme | 09 - 14 |
| ROBIN-MASSE Bauchdeckenhalter | 15 - 15 |
| ROCHARD | |
| Bauchdeckenhaken | 15 - 24 |
| Befestigungsgestell | 15 - 24 |
| Haltevorrichtung | 15 - 24 |
| ROCHESTER-CARMALT Arterienklemme | 09 - 12 |
| ROCHESTER-PEAN Arterienklemme | 09 - 13 |
| ROEDER Tuchklemme | 07 - 1 |
| ROGGE Sterilisierzange | 29 - 1 |
| ROUX Mini-Wundhaken | 13 - 11 |
| ROUX Wundhaken | 13 - 10 |
| ROUX-BABY Wundhaken | 13 - 11 |
| RUDD Hämorrhoidal-Ligatoren | 21 - 16 |
| RUMEL Präparierklemme | 09 - 16 |
| Runde Schale | 29 - 2 |
| RUSS. MOD. Chirurgische Pinzette | 05 - 11 |
| RYDER/FRENCH-EYE Nadelhalter | 11 - 13, 14 |

S

| | |
|------------------------------------|-------------|
| SAALFELD Komedonenquetscher | 25 - 2 |
| Säge Fingerring | 25 - 3 |
| Sägeblatt | 25 - 3 |
| SÄNGER Plazentar- und Abortuszange | 23 - 37; 38 |
| SANVENERO Schere | 03 - 13 |
| SAROT Arterienklemme | 09 - 14 |
| SAROT Nadelhalter | 11 - 11; 15 |

| | |
|------------------------------|--------------------------|
| SATINSKY Gefäßschere | 03 - 24 |
| SAUERBRUCH Wundhaken | 13 - 17 |
| Saugkanüle | 17 - 11 |
| Saugkürette | 23 - 24 |
| Saugrohr | 17 - 9; 10; 11 |
| SCALP-CONTOUR Wundspreizer | 15 - 2 |
| Schale, Nieren- | 29 - 2 |
| Schale, Spül- | 29 - 2; 3 |
| SCHAMBERG Komedonenquetscher | 25 - 2 |
| SCHEDE Löffel | 27 - 1 |
| Scheidenhalter | 23 - 5; 12; 21 |
| SCHERBAK Vaginalsepekulum | 23 - 4 |
| Schere, | |
| Bauchdecken- | 03 - 25 |
| Chirurgische | 03 - 1-6; 11; 16; 17; 31 |
| Chirurgische Feine | 03 - 14; 15; 40; 42 |
| Coronar- | 03 - 24 |
| Darm- | 03 - 26; 28 |
| Episiotomie- | 03 - 27; 28 |
| Fistel- | 03 - 26 |
| Gefäß- | 03 - 20 -24; 38; 39; 44 |
| Gips- | 03 - 29; 30 |
| Gynäkologische | 03 - 11; 24; 25; 37 |
| Inzisions- | 03 - 17 |
| IRIS- | 03 - 15; 40; 43 |
| Kephalotom- | 03 - 26 |
| Knorpel- | 03 - 21; 24 |
| Ligatur- | 03 - 18; 19 |
| Lungenlappen- | 03 - 24; 27 |
| Mikro- | 03 - 8; 45; 47 |
| Nabelschnur- | 03 - 28 |
| Nasen- | 03 - 19; 20; 44 |
| Neurochirurgische | 03 - 18 |
| Präparier- | 03 - 6; 10-13; 36; 41-44 |
| Präparier- (Mikro-) | 03 - 46 |
| Präparier- (Nerv-) | 03 - 13 |
| Sehnen- | 03 - 14; 43; 45 |
| Strabismus- | 03 - 14; 42 |
| Tonsillen- | 03 - 20; 21 |
| Uterus- | 03 - 5 |
| Verband- | 03 - 29; 30; 40 |
| SCHINK Dermatome | 01 - 11 |
| SCHINK Dermatome Spannplatte | 01 - 10 |
| Schlauchklemme | 07 - 6 |
| Schließzange | 21 - 9 |

INHALTSVERZEICHNIS DEUTSCH

| | | | |
|--------------------------------------|--------------------|--------------------------------|--------------------|
| Schlingendreher | 11 - 31 | SINGLEY-TUTTLE Fassspinzette | 05 - 5 |
| SCHMID Kanüle | 17 - 14 | Skalpell | 01 - 3; 4; 6; 7 |
| SCHMIEDEN Führungshohlsonde | 11 - 29 | Skalpell Anatomische | 01 - 7 |
| SCHMIEDEN Unterbindungsnadel | 11 - 25 | Skalpell, Griff- | 01 - 1; 2 |
| SCHMIEDEN-PAYR Führungshohlsonde | 11 - 29 | Skalpell, Klängen- | 01 - 5 |
| SCHMIEDEN-TAYLOR Schere | 03 - 20 | Skalpell steril einmal | 01 - 3; 4 |
| SCHNIDT-SAWTELL Tonsillenzange | 09 - 11 | SKENE Hakenzange | 23 - 19 |
| SCHROEDER Hakenzange | 23 - 18 | SMITH-BUIE Rektumspreizer | 21 - 12 |
| SCHUBERT Probeexzisionzange | 23 - 33 | SMITH-PETERSON Hohlmeißel | 27 - 10 |
| SCHUHKNECHT Wundspreizer | 15 - 3 | SMITH-PETERSON Osteotom | 27 - 10 |
| SCHUMACHER Nabelschur-Schere | 03 - 28 | SÖKELAND Gallensteinzange | 19 - 2 |
| SCHUMACHER Probeexzisionzange | 23 - 33 | SOMER Uterusfasszange | 23 - 21 |
| SCHUMACHER-VAN DOREN Biopsiezange | 23 - 32 | Sonde, | 17 - 1; 2; 30 |
| Schwammzange | 07 - 5 | Führungshohl- | 11 - 29; 30 |
| SCHWEIZER MOD. Nadelhalter | 11 - 14 | Gallenstein- | 19 - 3; 4 |
| SCHWEIZER MOD. Spekulum | 23 - 2 | Hohl- | 17 - 1; 2; 28 |
| SCUDDER Darmklemme | 21 - 10 | Intra-Uterus- | 23 - 14 |
| SEDILLOT Raspatorium | 27 - 6 | Knopf- | 17 - 1; 30 |
| SEGOND Myommesser | 23 - 25 | Ohr- | 17 - 1 |
| Sehnenschere | 03 - 14; 43; 45 | Uterus | 23 - 22; 23 |
| SELDINGER Biopsiekanüle | 17 - 13 | Spatel, Bauch- | 15 - 25 |
| SELETZ-GELPI Wundspreizer | 15 - 7 | Spatel, Blasen- | 19 - 8 |
| SEMB Bronchusklemme | 09 - 25 | Spekulum, Endo- | 23 - 13 |
| SEMKEN Anatomische Pinzette | 05 - 4 | Spekulum, Mastdarm- | 21 - 12 |
| SEMKEN Chirurgische-Pinzette | 05 - 10 | Spekulum, Vaginal- | 23 - 1-12; 14 |
| SEMM | 15 - 23 | SPENCER Ligaturschere | 03 - 19 |
| Bauchdeckenhalter Rahmen | 15 - 23 | SPENCER-WELLS Arterienklemme | 09 - 6 |
| Bauchdeckenhalter Valve | 15 - 23 | Sperrer, Rippen- | 15 - 26; 27 |
| Vaginalspekulum | 23 - 3 | Spezial Kanüle | 17 - 12 |
| SENN-GREEN Wundhaken | 13 - 5 | Sphinkteroskop | 21 - 14 |
| SENN-MILLER Wundhaken | 13 - 6 | Spitze | 17 - 4 |
| SENN-MILLER-BABY Wundhaken | 13 - 6 | Splitterpinzette | 05 - 14; 15 |
| SHORTBENT Ligaturschere | 03 - 18 | Spreizer, Blasenwund- | 19 - 6 |
| SIEBOLD Gynäkologische Schere | 03 - 25 | Spreizer, Rektum- | 21 - 12 |
| SILVER Dermatome | 01 - 11 | Spreizer, Wund- | 15 - 1- 13; 27 |
| SILVER Ersatzklinge | 01 - 11 | Spülkanüle | 17 - 12 |
| SIMON | | Spülröhr | 17 - 9 |
| Fistelhaken | 23 - 25 | Spülschale | 29 - 2 |
| Scheidenhalter | 13 - 21 | ST. MARKS Wundhaken | 13 - 27 |
| Uteruslöffel | 23 - 32 | STACKE Ohr Sonde | 17 - 1 |
| Wundhaken | 13 - 21 | Standard Anatomische Pinzette | 05 - 1 |
| SIMPSON Geburtszange | 23 - 35 | Standard Chirurgische Pinzette | 05 - 7 |
| SIMPSON Uterussonde | 23 - 23 | Standard Schere | 03 - 1; 2; 31 |
| SIMPSON-BRAUN Geburtszange | 23 - 35 | Standard Trocar | 17 - 5 |
| SIMPSON-LUIKART Geburtszange | 23 - 35 | Standzylinder | 29 - 2 |
| SIMS | | Stanze, Haut | 25 - 1 |
| Gynäkologische Schere | 03 - 24; 25; 37 | STAUDE-MOORE Hakenzange | 23 - 17 |
| Mastdarm-Spekulum | 21 - 12 | STELZNER Lungenlappenschere | 03 - 27 |
| Uterus Depressor | 23 - 22 | Sterilisierklammer | 29 - 1 |
| Uteruskürette | 23 - 27; 29 | Sterilisierzange | 29 - 1 |
| Uterussonde | 23 - 22 | Sternal-Punktionkanüle | 17 - 12 |
| Vaginalspekulum | 23 - 10; 11 | STEVENS Mikro-Schere | 03 - 47 |
| | | STEVENS Sehnenschere | 03 - 14, 43 |

STILLE

| | |
|---------------------------------|-------------|
| Anatomische Pinzette | 05 - 3 |
| Chirurgische Pinzette | 05 - 9 |
| Flachmeißel | 27 - 8 |
| Hohlmeißel | 27 - 9 |
| Nierensteinklemme | 09 - 23 |
| Osteotom | 27 - 8 |
| STOCKMANN Penisklemme | 19 - 10 |
| Stoff-Rolltasche | 23 - 16 |
| Strabismussschere | 03 - 14; 42 |
| STRATTE Nadelhalter | 11 - 5; 17 |
| STRAUSS Penisklemme | 19 - 10 |
| STRULLY Neurochirurgischeschere | 03 - 18 |
| SYME Unterbindungsnadel | 11 - 24 |

T

| | |
|--|-----------------|
| TAYLOR Anatomische Pinzette | 05 - 3 |
| TAYLOR Chirurgische Pinzette | 05 - 10 |
| TEALE Hakenzange | 23 - 19 |
| TERRIER Arterienklemme | 09 - 5 |
| THOMS-ALLIS Darmfazzange | 21 - 3 |
| THOMS-GAYLOR Probeexzisionzange | 23 - 32 |
| THOMSON-WALKER Blasenwundspreizer | 19 - 6 |
| THOREK Präparierschere | 03 - 13 |
| TISCHLER-BABY Biopsiezange | 23 - 34 |
| TISCHLER-KEVORKIAN Uterus-Biopsiezange | 23 - 34 |
| TISCHLER-MORGAN Biopsiezange | 23 - 34 |
| TOENNIS | |
| Arterienklemme | 09 - 18 |
| Nadelhalter | 11 - 5; 17 |
| Präparierschere | 03 - 17 |
| TOENNIS-ADSON Präparierschere | 03 - 10; 17; 42 |
| TOENNIS-ADSON Schere | 03 - 35 |
| TOHOKU-JAPAN Tuchklemme | 07 - 3 |
| Tonsillenzange | 09 - 11 |
| Tonsillenschere | 03 - 20; 21 |
| TOWNSEND Mini-Uterus-Biopsiezange | 23 - 34 |
| Trachealhaken | 13 - 3; 4 |
| Tränensackhäkchen | 13 - 3 |
| TRELAT Unterbindungsnadel | 11 - 27 |
| TREVES Chirurgische Pinzette | 05 - 13 |
| Trocare | 17 - 5-8; 15 |
| Trocare Kieferhöhlen | 17 - 7 |
| Trocare, Oberkiefer- | 17 - 7 |
| Tuchklemme | 07 - 1-3 |
| TUFFIER | |
| Arterienklemme | 09 - 3 |
| Bauchspatel | 15 - 25 |
| Rippensperrer | 15 - 26 |
| TUOHY Nadel | 17 - 15 |
| Tupferzange | 07 - 3; 4 |
| TURNER-WARWICK Gallensteinzange | 19 - 2 |
| TURNER-WARWICK Modif. Retraktor | 15 - 19 |

U

| | |
|--------------------------|-----------------|
| UCKERMANN Watterträger | 17 - 3 |
| Uhrmacher Pinzette | 05 - 17 |
| ULRICH Kornzange | 07 - 4 |
| Universal Drahtschere | 03 - 29; 40 |
| Universal Trocare | 17 - 5 |
| Universal Verbandsschere | 03 - 30 |
| UNNA Komedonenquetscher | 25 - 2 |
| Unterbindungsnadel | 11 - 23-27 |
| Uro-Tangential Klemme | 09 - 24 |
| Uterus | |
| Schere | 03 - 5 |
| Depressor | 23 - 16; 22 |
| Perforator | 23 - 25 |
| Biopsiezange | 23 - 32-34 |
| Dilatator | 23 - 15-17 |
| Fazzange | 23 - 21; 22 |
| Klemmzange | 23 - 37 |
| Kürette | 23 - 27; 29; 32 |
| Löffel | 23 - 32 |
| Sonde | 23 - 22; 23 |

V

| | |
|-----------------------------|-------------------------------|
| Vaginalspekulum | 23 - 1-12; 14 |
| Vaginalwundsperrer | 15 - 10 |
| VALLEIX Uterussonde | 23 - 23 |
| Valve | 15 - 6; 11-15; 18; 20; 21; 23 |
| VAN BUREN Hamröhrenkatheter | 19 - 9 |
| Venenhaken | 13 - 8 |
| Verbandschere | 03 - 29; 30; 40 |
| Verbindungsstück | 17 - 16; 17 |
| VERESS Insufflationskanüle | 17 - 13 |
| VERRES Kanüle | 17 - 13 |
| VIRCHOW Hirnmesser | 01 - 9 |
| VOLKMANN Löffel | 27 - 1; 3 |
| VOLKMANN Wundhaken | 13 - 13 |

W

| | |
|----------------------------------|------------|
| WACHENFELDT Wundklammerpinzette | 11 - 31 |
| WAGNER Feine Schere | 03 - 14 |
| WALB Autopsie Messer | 01 - 9 |
| WALDMANN Episiotomieschere | 03 - 28 |
| WALLICH Abortuslöffel | 23 - 38 |
| WALTER-CARMALT Splitterpinzette | 05 - 15 |
| WALTON Komedonenquetscher | 25 - 2 |
| WANGENSTEEN Anatomische Pinzette | 05 - 19 |
| WANGENSTEEN Nadelhalter | 11 - 4; 15 |
| WATSON-CHEYNE Elevator | 27 - 4 |
| Watteträger | 17 - 3 |
| WAUGH Anatomische Pinzette | 05 - 5 |
| WAUGH Chirurgische Pinzette | 05 - 11 |
| WEBSTER Nadelhalter | 11 - 1; 10 |

INHALTSVERZEICHNIS DEUTSCH

| | | | |
|--------------------------------|--------------------|--------------------------|--------------------|
| Wechselvalve | 15 - 14; 15; 18 | Zange, | |
| WEISSBARTH Vaginalspekulum | 23 - 3 | Biopsie- | 23 - 32-34 |
| WEITLANER Wundspreizer | 15 - 5; 6 | Gewebefass- | 21 - 2; 3 |
| WEITLANER-BABY Wundspreizer | 15 - 7 | Darmfass- | 21 - 2-5 |
| WEITLANER-LOKTITE Wundsperrerr | 15 - 5 | Dickdarm- | 21 - 9 |
| WERTHEIM | | Draht- | 11 - 16 |
| Hysterektomieklemme | 09 - 27 | Fass- | 19 - 7 |
| Klemmzange | 09 - 26 | Fadenführungs- | 19 - 7 |
| Vaginalspekulum | 23 - 12 | Fremdkörper- | 19 - 7 |
| WERTHEIM-CULLEN Klemmzange | 09 - 27 | Gallenstein- | 19 - 1; 2 |
| WESTCOTT Sehnenschere | 03 - 45 | Geburts- | 23 - 35; 36 |
| WIKSTROEM Präparierklemme | 09 - 19 | Haken- | 23 - 17-21 |
| WILLAUER Lungenlappen | 03 - 27 | Hämorrhoiden- | 23 - 17; 21 |
| WILLET-MARTEL Kopfhautklemme | 09 - 4 | Hämorrhoiden-Fass- | 21 - 17 |
| WILLIAMS Darmfasszange | 21 - 3 | Kapselass- | 19 - 7 |
| WILLIGER | | Klemm- | 09 - 26-29 |
| Elevator | 27 - 4 | Korn- | 07 - 4; 5 |
| Kürette | 27 - 3 | Lungenfass- | 09 - 24 |
| Raspatorium | 27 - 4; 6 | Mastdarm-Biopsie- | 21 - 16 |
| WINTER Abortuszange | 23 - 37 | Nagelausreiß- | 25 - 3 |
| WINTER Biopsiezange | 23 - 33 | Nagel-Zwick- | 25 - 3 |
| WRIGLEY Geburtszange | 23 - 35 | Nierenstein- | 19 - 1 |
| WULLSTEIN Wundspreizer | 15 - 3 | Plazentar- | 23 - 21; 37; 38 |
| Wund- | | Polypen- | 23 - 21 |
| Hauthäkchen | 13 - 1 | Präparier- und Ligatur | 09 - 15 |
| Trachealhaken | 13 - 3 | Probeexzisions- | 23 - 33 |
| Haken | 15 - 1-27 | Schließ- | 21 - 9 |
| Klammer | 11 - 32 | Schwamm- | 07 - 5 |
| Klammerbesteck | 11 - 32 | Sterilisier- | 29 - 1 |
| Klammerpinzette | 11 - 31; 32 | Tonsillen- | 09 - 11 |
| Klammerzängchen | 11 - 31 | Tupfer- | 07 - 3; 4 |
| Spreizer | 15 - 1-13; 27 | Uterus- | 23 - 21 |
| Spreizer, Appendektomie- | 15 - 4 | Uterus-Biopsie- | 23 - 32-34 |
| Spreizer, Blasen- | 19 - 6 | Uterusfass- | 23 - 21; 22 |
| Spreizer, Vaginal- | 15 - 10 | Uterusklemm- | 23 - 37 |
| | | zum Anlegen und Abnehmen | 09 - 1 |
| Y | | Zängchen, Wundklammer- | 11 - 31 |
| YANKAUER Saug- und Spülrohr | 17 - 9 | ZENKER Präparierklemme | 09 - 20 |
| YEOMAN Mastdarm-Biopsiezange | 21 - 16 | ZENKER Wundhaken | 13 - 23 |
| YOUNG Prostatahaken | 19 - 8 | Zirkel, Becken- | 23 - 38 |
| YOUNG-HRYNTSCHAK Nadelhalter | 11 - 26 | Zugseil | 17 - 4 |
| Z | | ZWEIFEL Nadelhalter | 11 - 20 |
| Zange, | | Zwickzange Nagel | 25 - 3 |
| Abortus- | 23 - 21; 37; 38 | Zwischenstück Luer-Lock | 17 - 16 |
| Atraumatische Darmfass- | 21 - 1 | | |

INDEX ENGLISH



INDEX ENGLISH

| | Page | | Page |
|--|---------------|---|-------------------------------|
| A | | | |
| Abdominal Retractor | 15 - 14-23 | Atraumatic Forceps | 05 - 18 |
| Abdominal Retractor Frame | 15 - 23 | Atraumatic Forceps, Intestinal Clamp | 21 - 1; 3; 4; 7 |
| Abdominal Retractor Valve | 15 - 23 | Autopsy Knife | 01 - 9 |
| Abdominal Scissors | 03 - 25 | AUVARD Vaginal Specula | 23 - 4 |
| Abdominal Spatula | 15 - 25 | AYRE Myoma Knife | 23 - 25 |
| ADAIR Uterine Tenaculum Forceps | 23 - 17 | B | |
| Adapter | 17 - 16; 17 | BABCOCK Atraumatic Intestinal and Tissue Grasping Forceps | 21 - 4 |
| ADLERKREUTZ Tissue Forceps | 05 - 9 | BABCOCK Intestinal and Tissue Grasping Forceps | 21 - 4 |
| ADSON | | BACKHAUS Towel Forceps | 07 - 1 |
| Chisel | 27 - 5 | BADGLEY Wound Spreaders, Self-Retaining | 15 - 27 |
| Elevator | 27 - 5 | BAGGISH Uterine Biopsy Forceps | 23 - 34 |
| Forceps, Dressing | 05 - 3; 8; 20 | BAINBRIDGE Haemostatic Forceps | 09 - 12 |
| Forceps, Haemostatic | 09 - 11 | BAKES Gall Dust Dilator | 19 - 5 |
| Holder, Needle | 11 - 2 | BALFOUR Abdominal Retractor | 15 - 17 |
| Raspatory | 27 - 5 | BALFOUR Exchangeable Blade | 15 - 18 |
| Tube, Suction | 17 - 9 | BALFOUR-BABY Abdominal Retractor | 15 - 18 |
| Wound Spreaders Self-Retaining | 15 - 2 | Bandage Scissors | 03 - 29; 30; 40 |
| ADSON-BABY Wound Spreaders, Self-Retaining | 15 - 2 | BARRAQUER Micro Needle Holder | 11 - 7 |
| ADSON-BABY Haemostatic Forceps | 09 - 15 | BARRAQUER Needle Holder | 11 - 21 |
| ADSON-BROWN Tissue Forceps | 05 - 9 | BARRAQUER-TROUTMAN Micro Needle Holder | 11 - 7 |
| ADSON-CONE Retractor | 15 - 7 | BARRETT Uterine Tenaculum Forceps | 23 - 17 |
| Adventitia Micro Scissors | 03 - 51 | BARRY Sternal Wire Twisting Forceps | 11 - 16 |
| ALAN-PARKS Anal Spreaders | 21 - 13 | Basket | 23 - 15 |
| ALEXANDER Chisel | 27 - 9 | Basket for Dilators | 23 - 16 |
| ALEXANDER Uterine Biopsy Forceps | 23 - 33 | BEACHAM Amniotome | 23 - 22 |
| ALLEN Intestinal Clamp | 21 - 1 | BECKMANN Wound Spreaders, Self-Retaining | 15 - 8; 9 |
| ALLIS | | BECKMANN-ADSON Wound Spreaders, Self-Retaining | 15 - 8 |
| Forceps, Atraumatic Intestinal and Tissue Grasping | 21 - 1; 3; | BENGOLEA Haemostatic Forceps | 09 - 13 |
| Forceps, Intestinal and Tissue Grasping | 21 - 1; 3 | BERGMANN Mallets | 27 - 11 |
| Forceps, Tissue Grasping | 21 - 1; 3 | BERGMANN Plaster of Paris | 03 - 29 |
| ALLIS-ADAIR Tissue Grasping Forceps | 21 - 2 | BERLIN Tubing Clamp | 07 - 6 |
| ALLIS-BABY Intestinal and Tissue Grasping Forceps | 21 - 1 | BERNHARD Towel Forceps | 07 - 2 |
| ALLISON Lung Spatula | 13 - 27 | BIER Lumbar Puncture Needle | 17 - 14 |
| ALLPORT Wound Spreaders, Self-Retaining | 15 - 1 | Biopsy Cannula | 17 - 13; 15 |
| ALM Wound Spreaders, Self-Retaining | 15 - 1 | Biopsy Curette | 23 - 24 |
| Amniotome | 23 - 22 | Biopsy Forceps | 23 - 16; 32; 33; 34 |
| Amputation Knife | 01 - 8; 10 | Biopsy Rectal Forceps | 21 - 16 |
| Anal Spreaders | 21 - 13 | BIRKETT Dissecting Forceps | 9 - 10 |
| ANDERSON-ADSON Wound Spreaders, Self-Retaining | 15 - 2 | Bladder Neck Spreader | 19 - 6 |
| ANDREW-PINCHON Suction Tube | 17 - 9 | Bladder Retractor | 19 - 8 |
| Angiotriebe | 09 - 5 | Blade | 15 - 6; 11-15; 18; 20; 21; 23 |
| Anuscope | 21 - 14; 15 | Blades, Scalpel- | 01 - 5 |
| ANTHONY Suction Tube | 17 - 9 | BLAKE Gall Stone Forceps | 19 - 2 |
| Appendectomy Wound Spreaders, Self-Retaining | 15 - 4 | BLAKE Uterine Curette | 23 - 32 |
| Atraumatic Clamp, Bulldog | 09 - 2; 3 | BOETTCHER Tonsil Scissors | 03 - 21 |

| | |
|---|------------------|
| Bone Curette | 27 - 1-4; 32; 38 |
| Bone Gouge | 27 - 7-10 |
| BONNEY Dissecting Forceps | 05 - 20 |
| BONNEY Dressing Forceps | 05 - 5 |
| Bougies | 19 - 9; 10 |
| Bowl Solution | 29 - 2 |
| BOYS-ALLIS Intestinal and Tissue Grasping Forceps | 21 - 3 |
| BOZEMANN | |
| Forceps, Dressing | 07 - 3; 4 |
| Holder, Needle | 11 - 16 |
| Loop Twister | 11 - 31 |
| Scissors, Gynaecological | 03 - 25 |
| Brain Knife | 01 - 9 |
| BRAITHWAITE spare Blade | 01 - 11 |
| BRAITHWAITE Dermatomes | 01 - 11 |
| BRAUN Modif. Vaginal Specula | 23 - 12 |
| BRAUN Uterine Depressor | 23 - 22 |
| BRAUN Uterine Tenaculum Forceps | 23 - 18; 20 |
| BRAUN-STADLER Episiotomy Scissors | 03 - 28 |
| BREISKY Vaginal Specula | 23 - 8 |
| BRODIE Director (Probe) Grooved | 17 - 1 |
| Bronchus Clamps | 09 - 22; 25 |
| BROPHY Dissecting Forceps | 05 - 11 |
| BROPHY Dressing Forceps | 05 - 5 |
| BROPHY-SULLIVAN Fine Scissors | 03 - 17 |
| BROWN Dissecting Forceps | 05 - 13 |
| BROWN Needle Holder | 11 - 2 |
| BRUNNER | |
| Clamp, Atraumatic Intestinal | 21 - 8 |
| Conductor, Ligature | 11 - 28 |
| Needle, Ligature | 11 - 25 |
| Retractor | 13 - 24 |
| BRUNNER-FERROZELL | 11 - 30 |
| Ligature Conductor | |
| BRUNS | |
| Bandage Scissors | 03 - 40 |
| Bone Curette | 27 - 1 |
| Plaster-of-Paris Shears | 03 - 30 |
| BRYANT Sponge and Dressing Forceps | 07 - 3 |
| BUCK Ligature Scissors | 03 - 19 |
| BUELAU Trocar | 17 - 6 |
| Bulldog Clamps | 09 - 1; 2; 3 |
| Bulldog Clamps, Vena | 09 - 2 |
| BUMM Uterine Curette | 23 - 30 |
| BUNT Safety Pin | 29 - 1 |
| BURKE Uterine Biopsy Forceps | 23 - 34 |
| BUSCH Umbilical Scissors | 03 - 28 |
| BYRD Suction Tube | 17 - 10 |
| C | |
| Cable Flexible | 17 - 4 |
| CAMPBELL Trocar | 17 - 7 |
| CAMPBELL Urethral Sounds | 19 - 10 |

| | |
|--|---------------------------|
| Cannula Biopsy | 17 - 13; 15 |
| Cannula Irrigation | 17 - 12 |
| Cannula Sternal Puncture | 17 - 12 |
| Cannula Suction | 17 - 11 |
| CANNY-RYAL Wound Retractor | 13 - 12 |
| CAPLAN Nasal Scissors | 03 - 20 |
| CARREL Haemostatic Forceps | 09 - 5 |
| Cartilage Scissors | 03 - 21; 24 |
| CASTROVIEJO Micro Needle Holder | 11 - 8 |
| CASTROVIEJO Needle Holder | 11 - 21 |
| Catheter | 19 - 9 |
| Catheter Guide | 19 - 10 |
| CATLIN Amputation Knife | 01 - 8 |
| Cephalotomy Scissors | 03 - 26 |
| Chain with Weight | 15 - 24 |
| CHAPUT Haemostatic Forceps | 09 - 3 |
| CHEATLE Sterilizing Forceps | 29 - 1 |
| CHELSEA EATON Anoscope | 21 - 15 |
| CHERON Dressing Forceps | 07 - 4 |
| CHILDE Wound Clamp | 11 - 32 |
| Chisel | 27 - 7-9 |
| Circumcision Instrument | 19 - 10 |
| Clamp | |
| Angiotriebe | 09 - 5 |
| Atraumatic-Bulldog | 09 - 3 |
| Bulldog | 09 - 1 |
| Dissecting | 09 - 6; 10; 16; 18-20; 22 |
| Forceps | 09 - 26; 27; 28; 29 |
| Gall Dust | 09 - 14; 21; 22 |
| Holder | 21 - 9 |
| Hysterectomy | 09 - 27 |
| Intestinal | 21 - 1-8; 10 |
| Intestinal Crushing | 21 - 9 |
| Kidney Pedicle | 09 - 23; 24 |
| Peritoneal | 09 - 25; 26 |
| Pylorus | 21 - 9 |
| Stomach | 21 - 10 |
| Tubing | 07 - 6 |
| Uterine | 23 - 37 |
| Vascular- | 09 - 1 |
| Vascular (Milti purpose) | 09 - 3-22 |
| Vena | 09 - 2 |
| CLAUS Ligature Needle | 11 - 27 |
| CLAUS-EICKEN Ligature Needle | 11 - 27 |
| Cleft Palate Needle | 11 - 27 |
| Clips, Wound | 11 - 32 |
| Closure Clamp | 21 - 9 |
| Cloth Bag | 23 - 16 |
| CLOWARD Wound Spreader, Self-Retaining | 15 - 12 |
| CLOWARD Modif. Blade | 15 - 12; 13 |
| COAKLEY Antrim Trocar | 17 - 7 |
| COGSWELL Suction Tube | 17 - 9 |

INDEX ENGLISH

| | |
|-------------------------------------|-----------------|
| COHEN Intra-Uterine Probe | 23 - 14 |
| Cold Light Carrier | 21 - 15 |
| COLLIER Needle Holder | 11 - 1 |
| COLLIN | |
| Forceps, Dressing | 07 - 4 |
| Forceps, Grasping | 09 - 3 |
| Forceps, Uterine Grasping | 23 - 22 |
| Forceps, Wound Clip | 11 - 31 |
| Knife, Amputation | 01 - 8 |
| Knife, Operating | 01 - 6 |
| Mallet | 27 - 11 |
| Probe, Uterine | 23 - 23 |
| Retractor Abdominal | 15 - 15 |
| Specula, Vaginal | 23 - 1 |
| COLLIN-BABY Abdominal Retractor | 15 - 14 |
| COLLIN-DUVAL Grasping Forceps | 05 - 12 |
| Comedone Extractor | 25 - 2 |
| Cone | 23 - 14 |
| CONE Wound Spreader, Self-Retaining | 15 - 7 |
| Connecting Piece | 17 - 16 |
| COOLEY Suction Tube | 17 - 9; 10 |
| COOPER Ligature Needle | 11 - 24 |
| COPPELSON Uterine Forceps | 23 - 34 |
| CORYKKOS Wound Retractor | 13 - 23 |
| COTTLE Nasal Scissors | 03 - 20 |
| Cotton Applicator | 17 - 3 |
| COUPLAND Exchangeable Suction | 17 - 9 |
| COXETER Catheter | 19 - 9 |
| CRAFOORD Haemostatic Forceps | 09 - 11 |
| CRAFOORD Lobectomy Scissors | 03 - 24 |
| CRAFOORD-SELLORS Bronchus Forceps | 09 - 22 |
| CRILE Haemostatic Forceps | 09 - 9 |
| CRILE-MURRAY Needle Holder | 11 - 2 |
| CRILE-RANKIN Haemostatic Forceps | 09 - 10 |
| CRILE-WOOD Needle Holder | 11 - 2; 11 |
| Cup | 29 - 2; 3 |
| Curette Biopsy | 23 - 24 |
| Curette Lupus | 25 - 1; 2 |
| Curette Ovum | 23 - 37 |
| Curette Suction | 23 - 24 |
| Curette, Uterine- | 23 - 27; 29; 32 |
| CUSCO Vaginal Speculum | 23 - 1; 2 |
| CUSHING | |
| Forceps | 05 - 20 |
| Forceps, Dissecting | 05 - 11 |
| Forceps, Dressing | 05 - 4 |
| Hook, Nerve | 13 - 4 |
| Retractor | 13 - 8 |
| CUSHING-TAYLOR Forceps | 05 - 20 |
| CZERNY | |
| Forceps, Gall Stone | 19 - 2 |
| Forceps, Uterine Tenaculum | 23 - 20 |
| Retractor, Double-Ended | 13 - 12 |

D

| | |
|-------------------------------------|---------------------------------|
| Dandy Haemostatic Forceps | 09 - 9 |
| Dandy Neurosurgical Scissors | 03 - 18 |
| DARTIGUES Uterine Elevating Forceps | 23 - 21 |
| DAUBENSPECK Bone Curette | 27 - 2 |
| DAVIDSON Trocar | 17 - 6 |
| DAVIDSON Wound Retractor | 13 - 27 |
| DE BAKEY | |
| Clamp, atraumatic Bulldog | 09 - 2 |
| Forceps, atraumatic | 05 - 18 |
| Forceps, vascular Atraumatic | 05 - 18 |
| Holder, Needle | 11 - 13 |
| Retractor, Self-Retaining | 15 - 9 |
| Scissors, vascular | 03 - 21; 23; 38 |
| Tube, Suction | 17 - 9 |
| DE LA ROZA Ligature Needle | 11 - 26 |
| DE LEE Obstetrical Forceps | 23 - 35 |
| DE MARTEL-WOLFSON | |
| Clamp Holder | 21 - 9 |
| Clamp Closure | 21 - 9 |
| Colon-Anastomosis Clamp | 21 - 9 |
| DEAVER Operating Scissors | 03 - 2 |
| DEAVER Wound Retractor | 13 - 25-27 |
| Delicate Haemostatic Forceps | 09 - 12 |
| Delicate Skin Hook | 13 - 1 |
| DENNIS-BROWNE Abdominal Retractor | 15 - 20 |
| Depressor Uterine | 23 - 22 |
| DERF Needle Holder | 11 - 1; 10 |
| DERF-CONVERSE Needle Holder | 11 - 1 |
| Dermal Punch | 25 - 1 |
| Dermatomes | 01 - 11 |
| DESCHAMPS Ligature Needle | 11 - 23; 24 |
| DESJARDINS | |
| Clamp, Gall Dust | 09 - 21 |
| Forceps, Gall Stone | 19 - 1 |
| Scoop, Gall Stone | 19 - 4 |
| DESMARRES Lid Retractor | 13 - 7 |
| DESMARRES Retractor | 13 - 7 |
| DIEFFENBACH Bulldog Clamps | 09 - 1 |
| DIEFFENBACH Operating Knife | 01 - 7 |
| DIETHRICH Micro Needle Holder | 11 - 10 |
| Dilator Gall Dust | 19 - 5 |
| Dilators Uterine | 23 - 16; 17 |
| Dilators Vessel | 05 - 17 |
| Director (Probe) Grooved | 17 - 1; 2; 28 |
| Disposable Scalpels Sterile | 01 - 3; 4 |
| Dissecting Forceps Ligature | 09 - 5-16; 18; 19; 20; 22 |
| Dissecting Knife Autopsy | 01 - 7 |
| Dissecting Knife Operating | 01 - 7 |
| Dissecting Scissors | 03 - 6; 10-13; 17; 34-36; 41-44 |
| Dissecting Scissors, Micro | 03 - 46 |
| DITTEL Urethral Sounds | 19 - 9 |

| | |
|--|------------------------------|
| DIXON-LOVELACE Haemostatic Forceps | 09 - 10 |
| DOUGALS Trocar | 17 - 8 |
| DOYEN | |
| Clamp Intestinal | 21 - 5; 6 |
| Forceps Polypus and Ovum | 23 - 21 |
| Holder Vaginal Specula | 23 - 12 |
| Probe | 17 - 1 |
| Raspatory Periosteal | 27 - 6 |
| Retractor Abdominal | 13 - 19 |
| Retractor Wound | 15 - 19; 24 |
| Scissors Abdominal | 03 - 25 |
| Screw Myoma | 23 - 25 |
| Specula Vaginal | 23 - 7 |
| DOYEN-BABY Intestinal Clamp | 21 - 5 |
| DOYEN-STILLE Retractor | 13 - 20 |
| Dressing Forceps | 05 - 1-5; 19; 20 07 - 3-5 |
| DUBOIS Cephalotomy Scissors | 03 - 26 |
| DUEHRSEN Dissecting Forceps | 05 - 12 |
| DUEHRSEN Dressing Forceps | 05 - 5 |
| DUPLAY Uterine Tenaculum Forceps | 23 - 18 |
| Dura and Skin Retractor | 13 - 1 |
| DUVAL Intestinal and Tissue Grasping Forceps | 21 - 4; 5 |
| DUVAL Intestinal Forceps | 05 - 12 |
| E | |
| Ear Probe | 17 - 1 |
| EISELSBERG Ligature Scissors | 03 - 18 |
| Elevator | 27 - 4 |
| ELLIOT Obstetrical Forceps | 23 - 36 |
| EMMET Fistula Hook | 23 - 25 |
| Endarterectomy Dissecting Scissors | 03 - 42 |
| ENGL. MOD. Towel Forceps | 07 - 1 |
| Enospecula | 23 - 13 |
| Episiotomy-Scissors | 03 - 27; 28 |
| EPPENDORF Uterine Biopsy Forceps | 23 - 33 |
| ESMARCH Bandage Scissors | 03 - 30 |
| Exchangeable Blade | 15 - 14; 15; 18 |
| F | |
| FALK Ligature Needle | 11 - 27 |
| FARABEUF Periosteal Raspatory | 27 - 5 |
| FARABEUF Wound Retractor | 13 - 10 |
| FARREL Cotton Applicator | 17 - 3 |
| FAURE Peritoneum Clamp-Forceps | 09 - 26 |
| FAURE Uterine Biopsy Forceps | 23 - 32 |
| FAVALORO Vascular Scissors | 03 - 23 |
| FEILCHENFELD Splinter Forceps | 05 - 15 |
| FERGUSON | |
| Angiotriebe | 09 - 5 |
| Scissors Operating | 03 - 17 |
| Scoops Gall Stone | 19 - 3 |
| Tube Suction | 17 - 11 |

| | |
|-----------------------------------|-----------------------------------|
| FERRIS-SMITH Dressing Forceps | 05 - 5; 13 |
| Fine Applicator Cotton | 17 - 3 |
| Fine Forceps Fine Pattern | 05 - 7 |
| Fine Hook | 13 - 1; 2 |
| Fine Scissors | 03 - 14-16; 40; 42; 44 |
| Fine Scissors Dissecting | 03 - 44 |
| Fine Scissors Operating | 03 - 15; 16; 40; 42 |
| Finger Nail Drill | 25 - 1 |
| Finger Ring Saw | 25 - 3 |
| FINOCCHIETTO | |
| Forceps Haemostatic | 09 - 22 |
| Holder Needle | 11 - 4; 15 |
| Lobectomy Scissors | 03 - 27 |
| Spreader Rib | 15 - 26 |
| FINOCCHIETTO-BABY Rib Spreader | 15 - 26 |
| FINSEN Wound Retractor | 15 - 1 |
| Fistula Hook | 21 - 17; 23 - 25 |
| Fixation Device | 15 - 24 |
| FOERSTER Sponge Holding | 07 - 5 |
| FOERSTER-BALLENGER Sponge Holding | 07 - 5 |
| FOMON Dissecting Scissors | 03 - 6 |
| FOMON Nasal Scissors | 03 - 19; 44 |
| Forceps | |
| Applying/Removal | 09 - 1 |
| Atraumatic- | 05 - 18 |
| Atraumatic Intestinal Grasping | 21 - 1 |
| Biopsy | 23 - 32-34 |
| Bronchus | 09 - 22; 25 |
| Capsule (Prostatic) | 19 - 7 |
| Clamp | 09 - 26-29 |
| Clamp Closing | 21 - 9 |
| Clip | 11 - 31; 32 |
| Colon-Anastomosis (Clamp) | 21 - 9 |
| Dissecting | 05 - 5-14 |
| Dissecting and Ligature | 09 - 15 |
| Dressing | 07 - 3-5 05 - 1-5; 18-20 |
| Dressing Grasping | 21 - 2; 3 |
| Foreign Body | 19 - 7 |
| Gall Stone | 19 - 1; 2 |
| Grasping (Organ) | 05 - 12; 09 - 3; 4 |
| Haemorrhoidal Grasping | 09 - 4; 5; 21 - 17; 23 - 21 |
| Haemostatic | 09 - 5-14 |
| Hook | 23 - 17-21 |
| Intestinal Grasping | 05 - 12; 21 - 2-5 |
| Jeweller Type | 05 - 17 |
| Kidney Stone | 19 - 1 |
| Ligature Carrying Forceps | 19 - 7 |
| Lung Grasping | 09 - 24 |

INDEX ENGLISH

| | |
|---|------------------------|
| Forceps | |
| Micro | 05 - 15 |
| Nail extracting | 25 - 3 |
| Nipper Nail | 25 - 3 |
| Obstetrical | 23 - 35; 36 |
| Ovum | 23 - 21; 37; 38 |
| Placenta | 23 - 21; 37; 38 |
| Polypus | 23 - 21 |
| Rectal Biopsy | 21 - 16 |
| Scalp | 09 - 4 |
| Sigmoid Anastomosis | 21 - 11 |
| Splinter | 05 - 14; 15 |
| Sponge | 07 - 5 |
| Sterilizing | 29 - 1 |
| Tonsil | 09 - 11 |
| Towel | 07 - 1; 2; 3 |
| Uro-Tangential | 09 - 24 |
| Uterine | 23 - 21 |
| Uterine Biopsy | 23 - 32-34 |
| Uterine Grasping | 23 - 21; 22 |
| Vascular- | 05 - 18 |
| Wire Twisting | 11 - 16 |
| Foreign Body Forceps | 19 - 7 |
| FOX Lupus Curette | 25 - 2 |
| Frame | 15 - 20 |
| Frame Abdominal Retractor | 15 - 23 |
| Frame, Mounting- | 15 - 24 |
| FRANZ Abdominal Retractor | 15 - 23 |
| FRAZIER Dura and Skin Retractor | 13 - 1 |
| FRAZIER Suction Tube | 17 - 11 |
| FRITSCH Retractor | 13 - 19 |
| G | |
| Gall Dust Clamp | 09 - 14; 21; 22 |
| Gall Dust Dilator | 19 - 5 |
| Gall Dust Probe | 19 - 3; 4 |
| Gall Stone Forceps | 19 - 1; 2 |
| Gall Stone Scoop | 19 - 3; 4 |
| GARLAND Clamp Forceps | 09 - 28 |
| GELPI Wound Spreaders, Self-retaining | 15 - 7 |
| GELPI-LOKTITE Wound Spreaders, Self-retaining | 15 - 7 |
| GEMINI Dissecting and Ligature Forceps | 09 - 19 |
| GERALD Dissecting Forceps | 05 - 20 |
| GERALD Dressing Forceps | 05 - 3, 4, 20 |
| GILLIES | |
| Forceps Dissecting | 05 - 9; 20 |
| Hook Dura and Skin | 13 - 1 |
| Needle Holder/Scissors | 11 - 17 |
| GIL-VERNET Retractor | 13 - 9 |
| GLASSMAN Intestinal Clamp Forceps | 21 - 8 |
| GLOVER Atraumatic-Bulldog | 09 - 3 |
| GOELET Retractor | 13 - 12 |

| | |
|--|--------------------------------------|
| GOMEL Micro Needle Holder | 11 - 7 |
| GOOD Tonsil Scissors | 03 - 21 |
| GOSSET Abdominal Retractor | 15 - 16 |
| Gouge | 27 - 7-10 |
| GRAEFE Delicate Hook | 13 - 1 |
| GRAEFE-IRIS Forceps | 05 - 16; 17 |
| Grasping Forceps | 05 - 5; 12 09 - 3 |
| Grasping Uterine Forceps | 23 - 21; 22 |
| GRAVE Vaginal Speculum | 23 - 3 |
| GRAY Gall Dust Clamp | 09 - 22 |
| GREEN-ARMYTAGE Caesarean Section Haemostatic Forceps | 23 - 37 |
| GROSS-MAIER Dressing Forceps | 07 - 5 |
| GUTHRIE Delicate Hook | 13 - 2 |
| GUYON | |
| Catheter Guide | 19 - 10 |
| Clamp Kidney Pedicle | 09 - 23 |
| Sounds Urethral | 19 - 10 |
| Gynaecological Scissors | 03 - 11; 24; 25; 37 |

H

| | |
|--------------------------------------|-------------------------------------|
| HABERER Abdominal Spatula | 15 - 25 |
| Haemorrhoidal Clamp | 09 - 4; 5 |
| Haemorrhoidal Forceps | 23 - 21 |
| Haemorrhoidal Forceps Grasping | 21 - 17 |
| Haemorrhoidal Ligators | 21 - 16 |
| Haemostatic Forceps | 09 - 3-22 |
| HAIGHT Rib Spreader | 15 - 27 |
| HALLE Bone Curette | 27 - 2 |
| HALLE Nasal Scissors | 03 - 19 |
| HALSEY Needle Holder | 11 - 1 |
| HALSTED Haemostatic Forceps | 09 - 7 |
| HALSTED-MOSQUITO Forceps | 09 - 7 |
| Handle | 17 - 4 |
| Handle, Scalpel | 01 - 1; 2 |
| HANK Uterine Dilators | 23 - 16 |
| HARRINGTON Retractor | 13 - 23 |
| HARTMANN Haemostatic Forceps | 09 - 6 |
| HAYNE | |
| Clamp-Forceps | 09 - 29 |
| Forceps Sigmoid Anastomosis | 21 - 11 |
| Needle Holder | 11 - 4 |
| HEANEY-BALLANTINE Clamp Forceps | 09 - 28 |
| HEANEY-KANTER Clamp Forceps | 09 - 28 |
| HEGAR Needle Holder | 11 - 16 |
| HEGAR Uterine Dilator | 23 - 15; 16 |
| HEGAR-BAUMGARTNER Needle Holder | 11 - 1; 10 |
| HEGEMANN-DIETHRICH Vascular Scissors | 3 - 22; 38; 39; 44 |
| HEGENBARTH Suture Forceps | 11 - 31 |
| HEISS Haemostatic Forceps | 09 - 14 |
| HENLEY Exchangeable Blade | 15 - 11 |
| HENLEY Self-Retaining Retractor | 15 - 11 |

| | |
|---|---------------------|
| HEPP-SCHEIDEL | |
| Micro Needle Holder | 11 - 20 |
| Micro Scissors | 3 - 45 |
| Suction Tube | 17 - 10 |
| HERRICK Kidney Pedicle Clamp Forceps | 09 - 24 |
| HESS Bulldog Clamps | 09 - 1 |
| HESSBERG Ligature Needle | 11 - 26 |
| HEYMANN Nasal Scissors | 03 - 20 |
| HEYMANN Tonsil Scissors | 03 - 20 |
| HEYWOOD-SMITH Haemorrhoidal Forceps | 23 - 21 |
| HIRSCHMANN Anuscope | 21 - 14 |
| Holder Clamp | 21 - 9 |
| Holder Needle | 11 - 4 |
| Holder Vaginal Specula | 23 - 5 |
| Hook Fistula | 21 - 17; 23 - 25 |
| Hook for Lacrimal Sack | 13 - 3 |
| Hook Nerve | 13 - 4 |
| Hook Prostatic | 19 - 8 |
| Hook Skin | 13 - 1 |
| Hook Tracheal | 13 - 3; 4 |
| HOSEMANN Haemostatic Forceps | 09 - 21 |
| HUMBY Dermatomes | 01 - 11 |
| HUNTER Splinter Forceps | 05 - 15 |
| HURD Cleft Palate Needle | 11 - 27 |
| HURWITZ Trocar | 17 - 5 |
| Hysterectomy Clamp-Forceps | 09 - 27 |
| Hysterectomy Dissecting Scissors | 03 - 36 |
| I | |
| Incision Scissors | 03 - 17 |
| Instrument, Boxes | 29 - 3 |
| Instruments Set Metal Case | 11 - 32 |
| Insufflations Needle, VERESS | 17 - 13 |
| Intestinal Clamp, Crushing | 21 - 9 |
| Intestinal Forceps | 05 - 12 |
| Intestinal Forceps, Clamp | 21 - 5-8; 10 |
| Intestinal Forceps, Grasping | 21 - 1-5 |
| Intestinal Scissors | 03 - 26 |
| Intra-Uterine Probe | 23 - 14 |
| IOWA Suction Tube | 17 - 12 |
| IOWA Tenaculum Forceps | 23 - 20 |
| IRIS | |
| Forceps | 05 - 16; 17 |
| Scissors | 03 - 15; 40; 43 |
| Scissors, Fine Operation | 03 - 15; 40 |
| Irrigation Cannula | 17 - 12 |
| ISRAEL Retractor | 13 - 14 |
| IVES FANSLER Anuscope | 21 - 15 |

| | |
|---|-------------|
| J | |
| JABALEY Fine Operation Scissors | 03 - 42 |
| JACKSON BURROWS Wound Spreaders Self-Retaining | 15 - 10 |
| JACKSON Vaginal Specula | 23 - 9 |
| JACOBI Ligature Needle | 11 - 26 |
| JACOBS Uterine Tenaculum Forceps | 23 - 19 |
| JAMISON Dissecting Scissors | 03 - 42 |
| JAMISON Needle Holder | 11 - 4 |
| JANSEN Bone Curette | 27 - 3 |
| JANSEN Wound Spreaders, Self-retaining | 15 - 1 |
| Jar | 29 - 2 |
| JARCHO Uterine Tenaculum Forceps | 23 - 18 |
| JEWELER'S Forceps | 05 - 17 |
| JOBSON-HORNE Cotton Applicator | 17 - 3 |
| JOHNS HOPKINS Bulldog Clamps | 09 - 1 |
| JOHNS-HOPKINS Haemostatic Forceps | 09 - 15 |
| JOHNSON Needle Holder | 11 - 4 |
| JOLL -FRIEDMAN Vaginal Retractor | 15 - 10 |
| JONES Towel Clamp | 07 - 1 |
| JOSEPH Scissors | 03 - 13 |
| JOSEPH Skin Hook | 13 - 1; 2 |
| JUDD-ALLIS Intestinal Grasping Forceps | 21 - 2 |
| JUDD-MASSON Bladder Retractor | 19 - 6 |
| K | |
| KAHN Uterine Tenaculum Forceps | 23 - 18 |
| KALLMORGEN Vaginal Specula | 23 - 9 |
| KALT Micro Needle Holder | 11 - 10 |
| KANTROWITZ Dissecting Forceps | 09 - 19 |
| KAYE FACE LIFT Dissecting Scissors | 03 - 41 |
| KELLY | |
| Forceps, Dissecting and Ligature | 09 - 18 |
| Forceps, Haemostatic- | 09 - 8 |
| Forceps, Polypus- | 23 - 21 |
| Proctoscope | 21 - 14 |
| Retractor | 13 - 18; 21 |
| Scissors, Fistula | 03 - 26 |
| Sphincteroscope | 21 - 14 |
| KELLY-RANKIN Haemostatic Forceps | 09 - 8 |
| KEVORKIAN Biopsy Curette | 23 - 24 |
| KEVORKIAN-PACIFIC Cervical Biopsy Forceps | 23 - 34 |
| KEVORKIAN-YOUNGE Biopsy Forceps | 23 - 33 |
| KEYES Dermal Punch | 25 - 1 |
| Kidney Pedicle Clamp | 09 - 23; 24 |
| Kidney Stone Forceps | 19 - 1 |
| Kidney Tray | 29 - 2 |
| KIELLAND Obstetrical Forceps | 23 - 36 |
| KILNER | |
| Needle Holder | 11 - 11 |
| Scissors | 03 - 12 |
| Scissors, Fine Dissecting | 03 - 44 |
| Skin, Hook | 13 - 1 |

INDEX ENGLISH

| | |
|---|-----------------|
| KIRSCHNER Abdominal Retractor | 15 - 21; 22 |
| KIRSCHNER Ligature Conductor | 11 - 30 |
| KLEINERT-KUTZ Delicate Hook | 13 - 1 |
| KLIMA-ROSSEGER Sternal Puncture Cannula | 17 - 12 |
| KLINKENBERGH-LOTH Vascular Scissors | 03 - 24 |
| KNAPP Delicate Hook | 13 - 3 |
| Knife Amputation | 01 - 8-10 |
| Knife Autopsy | 01 - 9 |
| Knife, Brain- | 01 - 9 |
| Knife Myoma | 23 - 25 |
| Knife Resection | 01 - 10 |
| Knot Tiers | 11 - 31 |
| KNOWLES Scissors | 03 - 30 |
| KOCHER | |
| Clamp, Atraumatic Intestinal | 21 - 7 |
| Clamp, Intestinal | 21 - 6 |
| Forceps Delicate Haemostatic | 09 - 12 |
| Needle Ligature | 11 - 25 |
| Probe | 11 - 30 |
| Retractor | 13 - 13; 17; 20 |
| Retractor Bladder | 19 - 8 |
| KOCHER-LANGENBECK Retractor | 13 - 16 |
| KOERTE Retractor | 13 - 14 |
| KOGAN Endospecula | 23 - 13 |
| KÖNIG Ligature Conductor | 11 - 29 |
| KÖNIG Raspatory | 27 - 5 |
| KRAUSE Trocar | 17 - 8 |
| KRISTELLER Vaginal Specula | 23 - 5; 9 |
| KROENLEIN Haemostatic Forceps | 09 - 5 |
| KRONECKER Ligature Needle | 11 - 26 |

L

| | |
|---|-------------|
| Lacrimal Sack Hook | 13 - 3 |
| LAHEY Gall Dust Clamp | 09 - 21 |
| LAHEY Retractor | 13 - 20 |
| LAMBOTTE | |
| Osteotome | 27 - 11 |
| Osteotome, Mini | 27 - 11 |
| Raspatory | 27 - 5 |
| LANDAU Trocar | 17 - 6 |
| LANDAU Vaginal Specula | 23 - 11 |
| LAN dolt Fine Scissors | 03 - 14 |
| LANE | |
| Clamp, Stomach | 21 - 10 |
| Clamp, Towel | 07 - 2 |
| Forceps, Dissecting | 05 - 13; 14 |
| Forceps, Intestinal and Tissue Grasping | 21 - 2 |
| LANGE Suture Forceps | 11 - 32 |
| LANGENBECK | |
| Elevator | 27 - 4 |
| Knife, Amputation | 01 - 9 |
| Needle, Holder | 11 - 20 |
| Respiratory Periosteal | 27 - 6 |
| Retractor | 13 - 14; 15 |
| Retractor, Mini | 13 - 5 |

| | |
|--|--------------------|
| LANGENBECK-GREEN Retractor | 13 - 4 |
| LAWRENCE Haemostatic Forceps | 09 - 21 |
| LAWRENCE Needle Holder | 11 - 3 |
| LEGUEU Bladder Retractor | 19 - 6 |
| LEGUEU Bladder Spatula | 19 - 8 |
| LEMPERT Bone Curette | 27 - 2 |
| LERICHE Haemostatic Forceps | 09 - 9 |
| LERMOYEZ Trocar | 17 - 7 |
| LEXER Dissecting Scissors | 03 - 11 |
| LEXER Scissors | 03 - 32 |
| LEXER-BABY Dissecting Scissors | 03 - 11 |
| LICHTENBERG Needle Holder | 11 - 6, 19 |
| LICHTWITZ Trocar | 17 - 8 |
| Lid Retractor | 13 - 7 |
| Ligator, Haemorrhoidal- | 21 - 16 |
| Ligature Catcher | 11 - 31 |
| Ligature Conductor | 11 - 29; 30 |
| Ligature Forceps | 09 -15, 18; 19; 22 |
| Ligature Needle | 11 - 23-27 |
| Ligature Scissors | 03 - 18; 19 |
| LINCOLN Vascular- Scissors | 03 - 20 |
| LISTER Bandage Scissors | 03 - 29, 40 |
| LISTER Towel Forceps | 07 - 3 |
| LISTON Amputation Knife | 01 - 8 |
| LITTAUER Ligature Scissors | 03 - 19 |
| LITTLE Retractor | 13 - 21 |
| LITTLE-WOOD Intestinal and Tissue Grasping Forceps | 21 - 2 |
| LLOYD-DAVIES Intestinal Scissors | 03 - 26 |
| Lobectomy Scissors | 03 - 24; 27 |
| LOCKHART-MUMMERY Probe | 17 - 2 |
| LOCKWOOD Intestinal and Tissue Grasping Forceps | 21 - 3 |
| LONG Clamp Forceps | 09 - 28 |
| Loop Twister | 11 - 31 |
| LORENZ Bandage Scissors | 03 - 30 |
| LORNA Towel Forceps | 07 - 2 |
| LOVELACE Lung Grasping Forceps | 09 - 24 |
| LOWER Haemostatic Forceps | 09 - 21 |
| LUER-KOERTE Gall Stone Scoop | 19 - 3 |
| LUER-LOCK Special Needle | 17 - 12 |
| LUMBAR Puncture Needle | 17 - 14; 15 |
| LUNG Grasping Forceps | 09 - 24 |
| LUNG Spatula | 13 - 27 |

M

| | |
|------------------------------|------------|
| M.G.H. Needle Holder | 11 - 2 |
| MAGILL Mandrin | 17 - 10 |
| MAGILL Suction Tube | 17 - 10 |
| MAINGOT Hysterectomy Forceps | 09 - 27 |
| Mallet | 27 - 8; 11 |
| MARTEL Scalp Flap Forceps | 09 - 4 |
| MARTIN Pelvimeter | 23 - 38 |
| MARTIN Probe, Uterine | 23 - 23 |

| | |
|---|-----------------------|
| MARTINI Bone Curette | 27 - 3 |
| MASSON Needle Holder | 11 - 4,15 |
| MATHIEU | |
| Forceps, Foreign Body | 19 - 7 |
| Holder, Needle | 11 - 6; 18; 19 |
| Retractor | 13 - 11 |
| Specula, Vaginal | 23 - 11 |
| Specula, Rectal | 21 - 12 |
| MATHIEU-KOCHER Needle Holder | 11 - 7; 18 |
| MATZENAUER Vaginal Specula | 23 - 12 |
| Maxillary Antrum Trocar | 17 - 7 |
| MAYO | |
| Pin, Safety | 29 - 1 |
| Probe, Gall Dust | 19 - 4 |
| Scissors | 03 - 5; 32; 41 |
| Scissors, Operating | 03 - 5 |
| Scoops, Gall Stone | 19 - 3 |
| Scissors Uterine | 03 - 5 |
| MAYO-ADAMS APPENDECTOMY Retractor | 15 - 4 |
| MAYO-BLAKE Gall Stone Forceps | 19 - 1 |
| MAYO-HEGAR Delicate Needle Holder | 11 - 3 |
| MAYO-HEGAR Needle Holder | 11 - 3; 12 |
| MAYO-NOBLE Operating Scissors | 03 - 6 |
| MAYO-ROBSON Intestinal Clamp | 21 - 7 |
| MAYO-ROBSON Atraumatic Intestinal Clamp Forceps | 21 - 7 |
| MAYO-STILLE Operating Scissors | 03 - 6 |
| MAYO-STILLE Scissors | 03 - 32 |
| MC DONALD Elevator | 27 - 4 |
| MC GIVNEY Haemorrhoidal Grasping Forceps | 21 - 17 |
| MC GIVNEY HAEMORROIDAL Ligator | 21 - 16 |
| MC INDOE | |
| Cartilage Scissors | 03 - 24 |
| Dressing Forceps | 05 - 3; 20 |
| Tissue Forceps | 05 - 10 |
| MC QUIGG-MIXTER Dissecting and Ligature Forceps | 09 - 22 |
| MEEKER Haemostatic Forceps | 09 - 20 |
| MENGHINI Liver Blind Puncture Needle | 17 - 15 |
| Metal Box | 23 - 15; 16 |
| Metal Catheter | 19 - 9 |
| METZENBAUM | |
| Delicate Scissors | 03 - 9 |
| Needle Holder | 11 - 2 |
| Scissors | 03 - 7; 8; 33; 34; 41 |
| METZENBAUM-BABY | |
| Scissors | 03 - 7 |
| Scissors Dissecting | 03 - 43 |
| Scissors Operating | 03 - 43 |
| METZENBAUM-FINO Dissecting Scissors | 03 - 10; 34-36; 41 |
| METZENBAUM-LAHEY Dissecting Scissors | 03 - 10 |
| METZENBAUM-NELSON Scissors | 03 - 7; 8; 41 |

| | |
|--|-------------------|
| MEYERDING Wound Retractor | 13 - 5; 24 |
| MICHEL | |
| Clip Forceps | 11 - 31; 32 |
| Clips | 11 - 32 |
| Forceps Suture | 11 - 32 |
| Instruments Set Suture | 11 - 32 |
| Micro Forceps | 05 - 15 |
| Micro Needle Holder | 11 - 7-10; 20 |
| Micro Scissors | 03 - 8; 45-47; 51 |
| Micro-ADSON | |
| Forceps, Dissecting | 05 - 8 |
| Forceps, Dissecting and Ligature | 09 - 15 |
| Forceps, Dressing Forceps | 05 - 3 |
| Micro-MOSQUITO Haemostatic Forceps | 09 - 8 |
| Micro-RYDER Needle Holder | 11 - 13 |
| MIKULICZ | |
| Clamp; Peritoneum | 09 - 25 |
| Forceps Sigmoid Anastomosis | 21 - 11 |
| Retractor | 13 - 22 |
| MIKULICZ-BABY Peritoneum Clamp-Forceps | 09 - 25 |
| MILAN Biopsy Curettes | 23 - 24 |
| MILLIGAN Wound Spreaders, Self-Retaining | 15 - 6 |
| MILLIN | |
| Forceps, Capsule | 19 - 7 |
| Forceps, Grasping | 19 - 7 |
| Forceps, Ligature Carrying | 19 - 7 |
| Spreaders, Bladder Wound | 19 - 7 |
| Spreaders, Bladder Neck | 19 - 7 |
| Mixing Bowl | 29 - 2 |
| MIXTER | |
| Forceps, Gall Stone | 19 - 1 |
| Forceps, Haemostatic | 09 - 20 |
| Scissors, Operation and Gynaecological | 03 - 11 |
| MIXTER-BABY Dissecting Forceps | 09 - 15 |
| MIXTER-BABY Haemostatic Forceps | 09 - 6 |
| MOCK Irrigation Cannula | 17 - 12 |
| MOD. BONN Scissors | 03 - 16 |
| MOD. ERLANGEN Uterine Perforator | 23 - 25 |
| MOD. USA Scissors | 03 - 28 |
| MOD. USA Tissue Forceps | 05 - 8 |
| MOD. WIEN Ligature Catcher | 11 - 31 |
| MOLLISON Retractor | 15 - 3 |
| MOORE Gall Bladder Scoops | 19 - 4 |
| MORGAN Proctoscope | 21 - 15 |
| MORRIS Retractor | 13 - 22 |
| Mounting Frame | 15 - 24 |
| MOYNIHAN Gall Stone Probe and Scoop | 19 - 3 |
| MOYNIHAN Hysterectomy Forceps | 09 - 27 |
| MUSEUX Uterine Tenaculum Forceps | 23 - 20 |
| Myoma Knife | 23 - 25 |
| Myoma Screw | 23 - 25 |
| MYRTLE Leaf Probe | 17 - 1 |

INDEX ENGLISH

N

NABATOFF

| | |
|----------------------------|--------|
| Cable Flexible | 17 - 4 |
| Handle | 17 - 4 |
| Metal-Case | 17 - 4 |
| Olive | 17 - 4 |
| Probe Tip Plastic Material | 17 - 4 |
| Probe Tip Metal | 17 - 4 |
| Varicose Vein Probe Set | 17 - 4 |

| | |
|-----------------------------|---------|
| NAEGELE Obstetrical Forceps | 23 - 36 |
|-----------------------------|---------|

| | |
|-----------------------|---------|
| NAGER Ligature Needle | 11 - 27 |
|-----------------------|---------|

| | |
|------------|--------|
| Nail Drill | 25 - 1 |
|------------|--------|

| | |
|--------------|--------|
| Nail Forceps | 25 - 3 |
|--------------|--------|

| | |
|---------------------|--------|
| Nail Nipper Forceps | 25 - 3 |
|---------------------|--------|

| | |
|----------------|--------------------|
| Nasal Scissors | 03 - 19; 20; 44 |
|----------------|--------------------|

| | |
|--------|------------|
| Needle | 11 - 22-27 |
|--------|------------|

| | |
|------|--------|
| Case | 29 - 3 |
|------|--------|

| | |
|--------------|---------|
| Cleft Palate | 11 - 27 |
|--------------|---------|

| | |
|--------|-----------|
| Holder | 11 - 1-21 |
|--------|-----------|

| | |
|---------------|---------------|
| Holder, Micro | 11 - 7-10; 20 |
|---------------|---------------|

| | |
|-----------------|--------|
| Holder/Scissors | 11 - 5 |
|-----------------|--------|

| | |
|----------------------|---------|
| Insufflations VERESS | 17 - 13 |
|----------------------|---------|

| | |
|----------|------------|
| Ligature | 11 - 23-27 |
|----------|------------|

| | |
|----------|---------|
| Puncture | 17 - 15 |
|----------|---------|

| | |
|------------------|---------|
| Puncture, Lumbar | 17 - 14 |
|------------------|---------|

| | |
|---------|---------|
| Special | 17 - 12 |
|---------|---------|

| | |
|-----------------------|---------|
| NEGUS Gall Dust Clamp | 09 - 14 |
|-----------------------|---------|

| | |
|-----------------------|--------|
| NEIVERT Needle Holder | 11 - 1 |
|-----------------------|--------|

NELATON

| | |
|-------------------|---------|
| Forceps, Grasping | 05 - 12 |
|-------------------|---------|

| | |
|-------|--------|
| Probe | 17 - 1 |
|-------|--------|

| | |
|--------|--------|
| Trocar | 17 - 7 |
|--------|--------|

| | |
|---------------------------|---------|
| Nerve Dissecting Scissors | 03 - 13 |
|---------------------------|---------|

| | |
|------------|--------|
| Nerve Hook | 13 - 4 |
|------------|--------|

| | |
|------------------------|---------|
| Neurosurgical Scissors | 03 - 18 |
|------------------------|---------|

| | |
|----------------------|--------|
| Nipper Forceps, Nail | 25 - 3 |
|----------------------|--------|

| | |
|--|---------|
| NORFOLK-NORWICH Wound Spreaders Self-Retaining | 15 - 10 |
|--|---------|

| | |
|-----------------------------|---------|
| NORTHBENT Ligature Scissors | 03 - 18 |
|-----------------------------|---------|

| | |
|----------------------|---------|
| NOTO POLYPUS Forceps | 23 - 21 |
|----------------------|---------|

| | |
|-----------------------|---------|
| NOVAK Suction Curette | 23 - 24 |
|-----------------------|---------|

O

| | |
|---------------------|-------------|
| Obstetrical Forceps | 23 - 35; 36 |
|---------------------|-------------|

| | |
|-------------------------|--------|
| OCHSNER Gall Dust Probe | 19 - 4 |
|-------------------------|--------|

| | |
|----------------|--------|
| OCHSNER Trocar | 17 - 7 |
|----------------|--------|

| | |
|------------------------------------|---------|
| OCHSNER-KOCHER Haemostatic Forceps | 09 - 13 |
|------------------------------------|---------|

| | |
|------------------------|--------|
| O'CONNOR Delicate Hook | 13 - 1 |
|------------------------|--------|

| | |
|-------|-----------|
| Olive | 17 - 4; 9 |
|-------|-----------|

| | |
|------------------------------------|--------|
| OLSEN-HEGAR Needle Holder/Scissors | 11 - 5 |
|------------------------------------|--------|

| | |
|-----------------|--------|
| Operating Knife | 01 - 6 |
|-----------------|--------|

| | |
|--------------------|---------------------------------|
| Operating Scissors | 03 - 1-6; 11; 15-17; 31; 40; 42 |
|--------------------|---------------------------------|

| | |
|-----------|-------------------|
| Osteotome | 27 - 7; 8; 10; 11 |
|-----------|-------------------|

| | |
|---|---------|
| O'SULLIVAN-O'CONNOR Abdominal Retractor | 15 - 20 |
|---|---------|

| | |
|---------------------------|---------|
| O'SULLIVAN-O'CONNOR Frame | 15 - 20 |
|---------------------------|---------|

| | |
|-----------------|---------|
| Ovarian Forceps | 23 - 21 |
|-----------------|---------|

| | |
|-----------------------------------|--------|
| OVERHOLT-BABY Haemostatic Forceps | 09 - 9 |
|-----------------------------------|--------|

| | |
|---------------------------------|---------|
| OVERHOLT-GEISSENDOERFER Forceps | 09 - 17 |
|---------------------------------|---------|

| | |
|-------------------------|---------|
| OVERHOLT-MIXTER Forceps | 09 - 15 |
|-------------------------|---------|

| | |
|--------------|---------|
| Ovum Curette | 23 - 37 |
|--------------|---------|

| | |
|-------------|---------|
| Ovum Scoops | 23 - 38 |
|-------------|---------|

P

| | |
|-------------------|---------|
| PAPARELL Scissors | 03 - 16 |
|-------------------|---------|

| | |
|------------------|---------|
| PARKER Retractor | 13 - 11 |
|------------------|---------|

| | |
|-----------------------------|---------|
| PARKER-LANGENBECK Retractor | 13 - 12 |
|-----------------------------|---------|

PARTSCH

| | |
|------------|--------|
| Bone Gouge | 27 - 8 |
|------------|--------|

| | |
|--------|--------|
| Chisel | 27 - 7 |
|--------|--------|

| | |
|--------|------------|
| Mallet | 27 - 8; 11 |
|--------|------------|

| | |
|--------------------------------|--------|
| PAYR Intestinal Crushing Clamp | 21 - 9 |
|--------------------------------|--------|

| | |
|-------------------------|---------|
| PAYR Ligature Conductor | 11 - 29 |
|-------------------------|---------|

| | |
|-------------------------------------|--------|
| PAYR-BABY Intestinal Crushing Clamp | 21 - 9 |
|-------------------------------------|--------|

| | |
|--------------------|--------|
| PAYR-PYLORUS Clamp | 21 - 9 |
|--------------------|--------|

| | |
|-----------------------------------|---------|
| PEAN Delicate haemostatic Forceps | 09 - 12 |
|-----------------------------------|---------|

| | |
|--------------------------|--------|
| PEAN Haemostatic Forceps | 09 - 6 |
|--------------------------|--------|

| | |
|---------------------------|--------|
| PEDERSON Vaginal Speculum | 23 - 3 |
|---------------------------|--------|

| | |
|---------------------|--------|
| PEERS Towel Forceps | 07 - 3 |
|---------------------|--------|

| | |
|---------------------------|--------|
| PELKMANN Dressing Forceps | 07 - 4 |
|---------------------------|--------|

| | |
|------------|---------|
| Pelvimeter | 23 - 38 |
|------------|---------|

| | |
|-------------|---------|
| Penis Clamp | 19 - 10 |
|-------------|---------|

| | |
|--------------------------------|--------|
| PENNINGTON haemostatic Forceps | 09 - 4 |
|--------------------------------|--------|

| | |
|------------|---------|
| Perforator | 23 - 25 |
|------------|---------|

| | |
|------------------|-------------|
| Peritoneal Clamp | 09 - 25; 26 |
|------------------|-------------|

| | |
|--------------------------------------|---------|
| PESTALOZZA Placenta and Ovum Curette | 23 - 37 |
|--------------------------------------|---------|

| | |
|-----------------|---------|
| PHANEUF Forceps | 09 - 26 |
|-----------------|---------|

| | |
|----------------------|--------|
| Pierce Antrum Trocar | 17 - 7 |
|----------------------|--------|

| | |
|-----------------------|--------|
| PIFFARD Lupus Curette | 25 - 1 |
|-----------------------|--------|

| | |
|-------------|--------|
| Pin, Safety | 29 - 1 |
|-------------|--------|

| | |
|---------------------------|---------|
| Piper Obstetrical Forceps | 23 - 36 |
|---------------------------|---------|

| | |
|---------------------------|-------------|
| Placenta and Ovum Forceps | 23 - 37; 38 |
|---------------------------|-------------|

| | |
|-------------------------|-------------|
| PLASTER-OF-PARIS Shears | 03 - 29; 30 |
|-------------------------|-------------|

| | |
|----------------------------------|--------|
| PLESTER Self-Retaining Retractor | 15 - 6 |
|----------------------------------|--------|

| | |
|-----------------|---------|
| POLYPUS Forceps | 23 - 21 |
|-----------------|---------|

| | |
|--------------------|--------|
| POOLE Suction Tube | 17 - 8 |
|--------------------|--------|

| | |
|--------------------------------|---------|
| POPPEN -FERGUSSON Suction Tube | 17 - 11 |
|--------------------------------|---------|

| | |
|-----------------------------------|---------|
| POTTS DE MARTEL Vascular Scissors | 03 - 38 |
|-----------------------------------|---------|

POTTS-SMITH

| | |
|---------------------|---------|
| Forceps, Dissecting | 05 - 11 |
|---------------------|---------|

| | |
|-------------------|------------|
| Forceps, Dressing | 05 - 4; 20 |
|-------------------|------------|

| | |
|----------|---------|
| Scissors | 03 - 27 |
|----------|---------|

| | |
|--------------------|-------------|
| Scissors, Vascular | 03 - 23; 39 |
|--------------------|-------------|

| | |
|---|-----------------|
| POZZI Uterine Tenaculum Forceps | 23 - 18 |
| PRATT | |
| Fistula Hook | 21 - 17 |
| Haemorrhoidal Forceps | 09 - 5 |
| Uterine Dilators | 23 - 17 |
| Uterine Tenaculum Forceps | 23 - 20 |
| PRESBYTERIAN Tubing Clamp | 07 - 6 |
| PRICE-THOMAS Forceps | 09 - 25 |
| PRINCE Tonsil Scissors | 03 - 21 |
| Probe | 17 - 1; 2; 30 |
| Probe Ear | 17 - 1 |
| Probe Gall Dust | 19 - 3; 4 |
| Probe Grooved Director | 17 - 1; 2; 28 |
| Probe Ingra-Uterine | 23 - 14 |
| Probe Ligature Conductor | 11 - 29; 30 |
| Probe Uterine | 23 - 22; 23 |
| Proctoscope | 21 - 14; 15 |
| Prostatic Retractor | 19 - 8 |
| PROVIDENCE-HOSPITAL Haemostatic Forceps | 09 - 7 |
| Punch Biopsy Forceps | 23 - 32; 33 |
| Punch Dermal | 25 - 1 |
| Puncture Cannula | 17 - 12; 14; 15 |
| PYE-SMITH (HARRISON) Sterilizing Forceps | 29 - 1 |
| PYLORUS Clamp | 21 - 9 |
| QUINKE Lumbar Puncture Needle | 17 - 15 |

R

| | |
|--------------------------------|-----------------------------|
| RADOLF Nail Forceps | 25 - 3 |
| RAGNELL Wound Retractor | 13 - 6 |
| RAGNELL-DAVIS Retractor | 13 - 6 |
| RAMPLEY Sponge Holding Forceps | 07 - 5 |
| Randall Kidney Stone Forceps | 19 - 1 |
| Randall Suction Curette | 23 - 24 |
| Raspatory | 27 - 4; 5; 6 |
| RECAMIER Curette | 23 - 26; 28 |
| Rectal Anal Retractor | 21 - 12 |
| Rectal Anastomosis Forceps | 21 - 11 |
| Rectal Biopsy Forceps | 21 - 16 |
| Rectal Scissors | 03 - 27 |
| Rectal Specula | 21 - 12 |
| Resection Knife | 01 - 10 |
| Retractor | 13 - 14 |
| Abdominal | 15 - 14-24 |
| Anal | 21 - 12 |
| Bladder | 19 - 6; 8 |
| Dura and Skin | 13 - 1 |
| Lid- | 13 - 7 |
| Vena | 13 - 8 |
| Wound | 13 - 1-27; 15 - 1-13; 27 |
| REVERDIN Abdominal Spatula | 15 - 25 |
| REVERDIN Needle | 11 - 22 |

| | |
|--|-----------------|
| REYNOLDS Dissecting Scissors | 03 - 12; 36; 43 |
| Rib Spreader | 15 - 26; 27 |
| RICARD Abdominal Retractor Spreader | 15 - 14 |
| RICHARDSON Retractor | 13 - 18 |
| RICHARDSON-EASTMAN Retractor | 13 - 19 |
| RICHTER Retractor | 15 - 10 |
| RICHTER-HEATH Clip Forceps | 11 - 31 |
| ROBERTS Haemostatic Forceps | 09 - 14 |
| ROBIN-MASSE Abdominal Retractor | 15 - 15 |
| ROCHARD | |
| Abdominal Retractor | 15 - 24 |
| Fixation Device | 15 - 24 |
| Mounting Frame | 15 - 24 |
| ROCHESTER-CARMALT Haemostatic Forceps | 09 - 12 |
| ROCHESTER-PEAN Haemostatic Forceps | 09 - 13 |
| ROEDER Towel Forceps | 07 - 1 |
| ROGGE Sterilizing Forceps | 29 - 1 |
| ROUX Mini Retractor | 13 - 11 |
| ROUX Retractor | 13 - 10 |
| ROUX-BABY Wound Retractor | 13 - 11 |
| RUDD Haemorrhoidal Ligators | 21 - 16 |
| RUMEL Dissecting Forceps | 09 - 16 |
| RUSS. MOD. Tissue Forceps | 05 - 11 |
| RYDER-FRENCH-EYE Needle Holder | 11 - 14 |

S

| | |
|--|-----------------|
| SAALFELD Comedone Extractor | 25 - 2 |
| Safety Pin | 29 - 1 |
| SÄNGER Placenta and Ovum Forceps | 23 - 37; 38 |
| SANVENERO Scissors | 03 - 13 |
| SAROT Haemostatic Forceps | 09 - 14 |
| SAROT Needle Holder | 11 - 11; 15 |
| SATINSKY Vascular Scissors | 03 - 24 |
| SAUERBRUCH Retractor | 13 - 17 |
| Saw Blade | 25 - 3 |
| Saw Finger Ring | 25 - 3 |
| Scalp Flap Forceps | 09 - 4 |
| Scalp-Contour Retractor | 15 - 2 |
| Scalpel | 01 - 3; 4; 6; 7 |
| Scalpel Blades | 01 - 5 |
| Scalpel Handle | 01 - 1; 2 |
| Scalpels Disposable | 01 - 3; 4 |
| SCHAMBERG Comedone Extractor | 25 - 2 |
| SCHEDE Bone Curette | 27 - 1 |
| SCHERBAK Vaginal Specula Handle | 23 - 4 |
| SCHINK Dermatomes | 01 - 11 |
| SCHINK Dermatomes Skin Straightening plat | 01 - 10 |
| SCHMID Needle | 17 - 14 |
| SCHMIEDEN Ligature Conductor | 11 - 29 |
| SCHMIEDEN Ligature Needle | 11 - 25 |
| SCHMIEDEN-PAYR Ligature Conductor | 11 - 29 |

INDEX ENGLISH

| | | | |
|--|-----------------------------|---|-----------------|
| SCHMIEDEN-TAYLOR DURA Scissors | 03 - 20 | SENN-GREEN Retractor | 13 - 5 |
| SCHNIDT-SAWTELL Tonsil Forceps | 09 - 11 | SENN-MILLER Retractor | 13 - 6 |
| SCHROEDER Forceps | 23 - 18 | SENN-MILLER-BABY Wound Retractor | 13 - 6 |
| SCHUBERT Uterine Biopsy Forceps | 23 - 33 | SHORTBENT Ligature Scissors | 03 - 18 |
| SCHUHKNECHT Retractor | 15 - 3 | SIEBOLD Gynaecological Scissors | 03 - 25 |
| SCHUMACHER Umbilical Scissors | 03 - 28 | SILVER Dermatomes | 01 - 11 |
| SCHUMACHER Uterine Biopsy Forceps | 23 - 33 | SILVER Dermatomes Spare Blade | 01 - 11 |
| SCHUMACHER-VAN DOREN Biopsy Forceps | 23 - 32 | SIMON | |
| Scissors | 03 - 1-41 | Holder, Vaginal | 13 - 21 |
| Incision | 03 - 17 | Hook, Fistula | 23 - 25 |
| Abdominal | 03 - 25 | Retractor | 13 - 21 |
| Bandage | 03 - 29; 30; 40 | Scoop, Uterine | 23 - 32 |
| Cartilage | 03 - 21; 24 | SIMPSON Obstetrical Forceps | 23 - 35 |
| Cephalotomy | 03 - 26 | SIMPSON Uterine Probe | 23 - 23 |
| Coronary | 03 - 24 | SIMPSON-BRAUN Obstetrical Forceps | 23 - 35 |
| Dissecting | 03 - 6; 10-13; 36; 41-44 | SIMPSON-LUIKART Obstetrical Forceps | 23 - 35 |
| Dissecting (Nerve) | 03 - 13 | SIMS | |
| Dissection, Micro | 03 - 46 | Scissors, Gynaecological | 03 - 24; 25; 37 |
| Episiotomy- | 03 - 26; 27; 28 | Specula, Rectal | 21 - 12 |
| Fine | 03 - 14; 15; 40 | Curette, Uterine | 23 - 27; 29 |
| Fine Operating- | 03 - 42 | Depressor, Uterine | 23 - 22 |
| Fistula | 03 - 26 | Probe, Uterine | 23 - 22 |
| Gynaecological | 03 - 11; 24; 25; 37 | Specula, Vaginal | 23 - 10; 11 |
| IRIS | 03 - 15; 40; 43 | SINGLEY-TUTTLE Grasping Forceps | 05 - 5 |
| Ligature | 03 - 18; 19 | SKENE Uterine Tenaculum Forceps | 23 - 19 |
| Lobectomy | 03 - 24; 27 | Skin Hook | 13 - 1 |
| Micro | 03 - 8; 45; 47 | Skin Lupus Curette | 25 - 1; 2 |
| Nasal | 03 - 19; 20; 44 | SMITH-BUIE Anal Retractor | 21 - 12 |
| Neurosurgical | 03 - 18 | SMITH-PETERSEN Gouge | 27 - 10 |
| Operating | 03 - 1-6; 11; 16; 17; 31 | SMITH-PETERSEN Osteotome | 27 - 10 |
| Plaster of Paris Shears | 03 - 29; 30 | SÖKELAND Gall Stone Forceps | 19 - 2 |
| Scoop Gall Stone | 19 - 3; 4 | Solution Bowl | 29 - 2 |
| Scoops Ovum | 23 - 38 | SOMER Uterine Elevating Forceps | 23 - 21 |
| Strabismus | 03 - 14; 42 | Spare Blade | 01 - 11 |
| Tenotomy | 03 - 14; 43; 45 | Spatula Abdominal | 15 - 25 |
| Tonsil | 03 - 20; 21 | Special Needle | 17 - 12 |
| Umbilical | 03 - 28 | Specula, Endo- | 23 - 13 |
| Uterine | 03 - 5 | Specula Rectal | 21 - 12 |
| Vascular- | 03 - 20-24; 38; 39; 44 | Specula Vaginal | 23 - 1-12; 14 |
| Screw Myoma | 23 - 25 | SPENCER Ligature Scissors | 03 - 19 |
| SCUDDER Intestinal Clamp | 21 - 10 | SPENCER-WELLS Haemostatic Forceps | 09 - 6 |
| SEDILLOT Raspatory | 27 - 6 | Sphincteroscope | 21 - 14 |
| SEGOND Myoma Knife | 23 - 25 | Splinter Forceps | 05 - 14; 15 |
| SELDINGER-STILLE Biopsy-Cannula | 17 - 13 | Sponge Holding Narrow | 07 - 5 |
| SELETZ-GELPI Laminectomy Retractor | 15 - 7 | Spreader RIB | 15 - 26; 27 |
| SEMB Bronchus Clamps | 09 - 25 | Spring screw cap | 17 - 16 |
| SEMKEN Dissecting Forceps | 05 - 10 | ST. MARKS Wound Retractor | 13 - 27 |
| SEMKEN Dressing Forceps | 05 - 4 | STACKE Ear Probe | 17 - 1 |
| SEMM Abdominal Retractor Valve | 15 - 23 | Standard Dissecting Forceps | 05 - 7 |
| SEMM Vaginal Specula | 23 - 3 | Standard Dressing Forceps | 05 - 1 |
| | | Standard Scissors | 03 - 1; 2; 31 |
| | | Standard Trocar | 17 - 5 |
| | | STAUDE-MOORE Uterine Tenaculum Forceps | 23 - 17 |
| | | STELZNER Lobectomy Scissors | 03 - 27 |

| | |
|---|----------------------|
| Sterilizing Forceps | 29 - 1 |
| Sternal Puncture Cannula | 17 - 12 |
| STEVENS Micro Scissors | 03 - 47 |
| STEVENS Tenotomy Scissors | 03 - 14, 43 |
| STILLE | |
| Chisels | 27 - 8 |
| Dissecting Forceps | 05 - 9 |
| Dressing Forceps | 05 - 3 |
| Gouge | 27 - 9 |
| Kidney Pedicle Clamp | 09 - 23 |
| Osteotome | 27 - 8 |
| STOCKMANN Meatus Clamp | 19 - 10 |
| Stomach Clamp | 21 - 10 |
| Stopcock, One-way | 17 - 16; 17 |
| Stopcock, Three-way | 17 - 16 |
| Strabismus Scissors | 03 - 14; 42 |
| STRATTE Needle Holder | 11 - 5; 17 |
| STRAUSS Meatus Clamp | 19 - 10 |
| STRULLY | |
| Neurosurgical Scissors | 03 - 18 |
| Suction Cannula | 17 - 11 |
| Suction Curette | 23 - 24 |
| Suction Tube | 17 - 8; 9; 10; 11 |
| Suture Instruments | 11 - 32 |
| SWEDISH Pattern Needle Holder | 11 - 14 |
| SWEDISH Pattern Vaginal Specula | 23 - 2 |
| SYME Ligature Needles | 11 - 24 |
| T | |
| TAYLOR Dissecting Forceps | 05 - 10 |
| TAYLOR Dressing Forceps | 05 - 3 |
| TEALE Uterine Tenaculum Forceps | 23 - 19 |
| Tenotomy Scissors | 03 - 14; 43; 45 |
| TERRIER Haemostatic Forceps | 09 - 5 |
| THOMS-ALLIS Intestinal Grasping Forceps | 21 - 3 |
| THOMS-GAYLOR Biopsy Punch Forceps | 23 - 32 |
| THOMSON-WALKER Bladder Wound Spreader | 19 - 6 |
| THOREK Dissecting Scissors | 03 - 13 |
| Tiers, Knot | 11 - 31 |
| Tip | 17 - 4 |
| TISCHLER-BABY Biopsy Forceps | 23 - 34 |
| TISCHLER-KEVORKIAN Uterine Biopsy Forceps | 23 - 34 |
| TISCHLER-MORGAN Cervical Biopsy Forceps | 23 - 34 |
| Tissue Grasping Forceps | 21 - 2, 3 |
| TOENNIS | |
| Forceps, Haemostatic | 09 - 18 |
| Needle Holder | 11 - 5; 17 |
| Scissors, Dissecting | 03 - 17 |
| TOENNIS-ADSON Dissecting Scissors | 03 - 10; 17; 42 |
| TOENNIS-ADSON Scissors | 03 - 35 |
| TOHOKU-JAPAN Towel Forceps | 07 - 3 |

| | |
|---|--------------|
| Tonsil Forceps | 09 - 11 |
| Tonsil Scissors | 03 - 20; 21 |
| Towel Forceps | 07 - 1-3 |
| TOWNSEND Mini Uterine Biopsy Forceps | 23 - 34 |
| Tracheal Hook | 13 - 3; 4 |
| Tray Kidney | 29 - 2 |
| TRELAT Ligature Needle | 11 - 27 |
| TREVES Tissue Forceps | 05 - 13 |
| Trocar | 17 - 5-8; 15 |
| Trocar Maxillary Antrum | 17 - 7 |
| Trocar Pierce Antrum | 17 - 7 |
| Tubing Clamp | 07 - 6 |
| TUFFIER Abdominal Spatula | 15 - 25 |
| TUFFIER Haemostatic Forceps | 09 - 3 |
| TUFFIER Rib Spreader | 15 - 26 |
| TUOHY Needle | 17 - 15 |
| TURNER-WARWICK Gall Stone Forceps | 19 - 2 |
| TURNER-WARWICK Modif. Abdominal Retraktor | 15 - 19 |

U

| | |
|-----------------------------|-----------------|
| UCKERMANN Cotton Applicator | 17 - 3 |
| ULRICH Polypus Forceps | 07 - 4 |
| Umbilical Scissors | 03 - 28 |
| Univetsal Bandage Scissors | 03 - 30 |
| Univetsal Trocars | 17 - 5 |
| Univetsal Wire Scissors | 03 - 29; 40 |
| UNNA Comedone Extractor | 25 - 2 |
| Urethral Sounds | 19 - 9 |
| Uro-Tangential Forceps | 09 - 24 |
| Uterine | |
| Clamp-Forceps | 23 - 37 |
| Curette | 23 - 27; 29; 32 |
| Depressor | 23 - 16; 22 |
| Dilators | 23 - 15-17 |
| Forceps | 23 - 32-34 |
| Forceps Biopsy | 23 - 32-34 |
| Forceps Grasping | 23 - 21; 22 |
| Forceps Tenaculum | 23 - 17-20 |
| Perforator | 23 - 25 |
| Probe | 23 - 22; 23 |
| Scissors | 03 - 5 |
| Scoop | 23 - 32 |

V

| | |
|-----------------------------------|----------------|
| Vaginal Specula | 23 - 1-12; 14 |
| Vaginal Specula Handle | 23 - 5; 12; 21 |
| Vaginal-Self-Retaining Retractor | 15 - 10 |
| VALLEIX Uterine Probe | 23 - 23 |
| VAN BUREN Urethral Dilator Bougie | 19 - 9 |
| VAN BUREN Urethral Sounds | 19 - 9 |
| Varicose Vein Probe Set | 17 - 4 |

INDEX ENGLISH

| | | | |
|--|---------------------------|---|---------------|
| Vascular Clamps | 09 - 1 | WIKSTROEM Dissecting Forceps | 09 - 19 |
| Vascular-Forceps Atraumatic | 05 - 18 | WILLAUER Lobectomy Scissors | 03 - 27 |
| Vascular-Scissors | 03 - 20-24; 38; 39; 44 | WILLET-MARTEL Scalp Flap Forceps | 09 - 4 |
| Vena Hook | 13 - 8 | WILLIAMS Intestinal Grasping Forceps | 21 - 3 |
| VERESS Insufflations Needle | 17 - 13 | WILLIGER | |
| VERRES Needle | 17 - 13 | Bone Curette | 27 - 3 |
| VESSEL Dilators | 05 - 17 | Elevator | 27 - 4 |
| VIRCHOW Brain Knife | 01 - 9 | Periosteal Raspatory | 27 - 4; 6 |
| VOLKMANN Bone Curette | 27 - 1; 3 | WINTER Ovum Forceps | 23 - 37 |
| VOLKMANN Wound Retractor | 13 - 13 | Wire Shears | 03 - 29; 40 |
| | | Wire Twisting Forceps | 11 - 16 |
| | | WITTNER Biopsy Forceps | 23 - 33 |
| W | | Wound- | |
| WACHENFELDT Suture Forceps | 11 - 31 | Clip Forceps | 11 - 31 |
| WAGNER Fine Scissors | 03 - 14 | Hook | 15 - 1-27 |
| WALB Post Mortem Knife | 01 - 9 | Hook, Skin Delicate | 13 - 1 |
| WALDMANN Episiotomy Scissors | 03 - 28 | Hook, Tracheal | 13 - 3 |
| WALLICH Ovum Scoops | 23 - 38 | Spreaders | 15 - 1-13; 27 |
| WALTER-CARMALT Splinter Forceps | 05 - 15 | Spreaders Appendectomy | 15 - 4 |
| WALTON Comedone Extractor | 25 - 2 | Spreaders Bladder | 19 - 6 |
| WANGENSTEEN Dressing Forceps | 05 - 19 | Spreaders Vaginal- | 15 - 10 |
| WANGENSTEEN Needle Holder | 11 - 4; 15 | Suture Forceps Clip | 11 - 31; 32 |
| WATSON-CHEYNE Elevator | 27 - 4 | Suture Instruments Set | 11 - 32 |
| WAUGH Dissecting Forceps | 05 - 11 | WRIGLEY Obstetrical Forceps | 23 - 35 |
| WAUGH Dressing Forceps | 05 - 5 | WULLSTEIN Self-Retaining ' Retractor | 15 - 3 |
| WEBSTER Needle Holder | 11 - 1; 10 | | |
| WEISSBARTH Vaginal Specula | 23 - 3 | Y | |
| WEITLANER Wound Spreaders, Self Retaining | 15 - 5; 6 | YANKAUER Suction Tube | 17 - 9 |
| WEITLANER-BABY Wound Spreaders, Self Retaining | 15 - 7 | YEOMAN Rectal Biopsy Forceps | 21 - 16 |
| WEITLANER-LOKTITE Wound Spreaders, Self Retaining | 15 - 5 | YOUNG Prostatic Retractor | 19 - 8 |
| WERTHEIM | | YOUNG-HRYNTSCHAK Needle Holder | 11 - 26 |
| Clamp-Forceps | 09 - 26 | | |
| Clamp-Forceps, Hysterectomy | 09 - 27 | Z | |
| Vaginal Specula | 23 - 12 | ZENKER Dissecting Forceps | 09 - 20 |
| WERTHEIM-CULLEN Clamp-Forceps | 09 - 27 | ZENKER Retractor | 13 - 23 |
| WESTCOTT Tenotomy Scissors | 03 - 45 | ZWEIFEL Needle Holder | 11 - 20 |

INDEX FRANÇAIS



| | Page | | Page |
|---|-------------|--|-------------|
| A | | | |
| ADAIR Pince pour le col de l'utérus | 23 - 17 | BABY-OVERHOLT Pince hémostatique | 09 - 9 |
| ADLERKREUTZ Pince à dissection à griffes | 05 - 9 | BABY-TISCHLER Pincés pour biopsie | 23 - 34 |
| ADSON | | BACKHAUS Pince à champs | 07 - 1 |
| Ecarteur autostatique | 15 - 2 | BADGLEY Ecarteur autostatique | 15 - 27 |
| Elévateur | 27 - 5 | BAGGISH Pince utérines | 23 - 34 |
| Pince à dissection | 05 - 3 | BAINBRIDGE Pince hémostatique (artères) | 09 - 12 |
| Pince à dissection à griffes | 05 - 8 | BAKES Sonde à calculs biliaires | 19 - 5 |
| Pince hémostatique (artères) | 09 - 11 | BALFOUR US Ecarteur abdominal | 15 - 17 |
| Porte-aiguille | 11 - 2 | BALFOUR Valve centrale | 15 - 18 |
| Tube d'aspiration | 17 - 9 | BALFOUR-BABY Ecarteur abdominal | 15 - 18 |
| ADSON-BABY Pince hémostatique (artères) | 09 - 15 | BARRAQUER Porte-aiguille | 11 - 7 |
| ADSON-BABY Ecarteur autostatique | 15 - 2 | BARRAQUER-TROUTMAN Porte-aiguille | 11 - 7 |
| ADSON-BROWN Pince à dissection à griffes | 05 - 9 | BARRETT Pince utérine | 23 - 17 |
| ADSON-CONE Ecarteurs autostatiques | 15 - 7 | BARRY STERNAL Pince pour fils | 11 - 16 |
| Adventitia ciseaux micro vasculaires | 03 - 51 | Bassins rénitiformes | 29 - 2 |
| Agrafes | 11 - 32 | BEACHAM Amniotome | 23 - 22 |
| Aiguille | | BECKMANN Ecarteur autostatique | 15 - 9 |
| biopsie | 17 - 15 | BECKMANN-ADSON Ecarteur autostatique | 15 - 8 |
| ligatures | 11 - 22-26 | BENGOLEA Pince hémostatique | 09 - 13 |
| pour anesthésie | 17 - 12 | BERGMANN Ciseaux à bandages | 03 - 29 |
| pour ponction lombaire | 17 - 14; 15 | BERGMANN Maillet | 27 - 11 |
| pour ponction sternal | 17 - 12 | BERLIN Pince presse-tubes | 07 - 6 |
| spéciales | 17 - 12 | BERNHARD Pince à champs | 07 - 2 |
| ALAN-PARKS Speculum rectal | 21 - 13 | BIER Aiguille pour ponction lombaire | 17 - 14 |
| ALAN-PARKS Valve | 21 - 13 | BIRKETT Pince à disséquer et à ligatures | 09 - 10 |
| ALEXANDER Ciseau-burin | 27 - 9 | Bistouri à dissection | 01 - 6; 7 |
| ALEXANDER Pince à biopsie | 23 - 33 | Bistouri à usage unique | 01 - 3 |
| ALLEN Pince intestinale | 21 - 1 | Bistouri manche | 01 - 2 |
| ALLIS | | Bistouri pour le cône d'attraction | 23 - 25 |
| Pince intestinale | 21 - 1 | BLAKE Curettes utérines | 23 - 32 |
| Atrauma pince intestinale | 21 - 1 | BLAKE Pincés pour calculs biliaires | 19 - 2 |
| Pince pour saisir intestins et tissus | 21 - 3 | BOETTCHER Ciseaux à amygdales | 03 - 21 |
| ALLIS-ADAIR Pince intestinale | 21 - 2 | Boite métal | 23 - 15; 16 |
| ALLIS-BABY Pince intestinale | 21 - 1 | Boîtes de Pétri | 29 - 3 |
| ALLISON Spatule pulmonaire | 13 - 27 | Boîtes pour instruments | 29 - 3 |
| ALLPORT Ecarteur autostatique | 15 - 1 | Bonn fins ciseaux chirurgicaux | 03 - 16 |
| ALM Ecarteur autostatique | 15 - 1; 2 | BONNEY Pince à dissection à griffes | 05 - 13; 20 |
| Amniotome | 23 - 22 | Bougie dilateur | 19 - 9 |
| ANDERSON-ADSON Ecarteur autostatique | 15 - 2 | Bougies urétrales | 19 - 9; 10 |
| ANDREWS-PINCHON Tube d'aspiration | 17 - 9 | BOYS ALLIS Pince pour saisir intestins et tissus | 21 - 3 |
| Angiotribe | 09 - 5 | BOZEMANN | |
| Anuscope | 21 - 14; 15 | Ciseaux gynécologiques | 03 - 25 |
| Atrauma pince | 05 - 18 | Pince à tampons | 07 - 3; 4 |
| Attrape-fil | 11 - 31 | Porte-aiguille | 11 - 16 |
| AUVARD Speculum vaginal | 23 - 4 | Tords-fil | 11 - 31 |
| AYRE Bistouri pour le cône d'attraction | 23 - 25 | BRAITHWAITE Dermatome lame de rechange | 01 - 11 |
| B | | | |
| BABCOCK Pince intestinale, atrauma | 21 - 4 | BRAITHWAITE Dermatome | 01 - 11 |
| BABCOCK Pince pour saisir intestins et tissus | 21 - 4 | BRAUN Dépresseur utérin | 23 - 22 |
| BABY-MIXTER Pince à disséquer et à ligatures | 09 - 15 | BRAUN Modif. Speculum vaginal | 23 - 12 |
| BABY-MIXTER Pince hémostatique | 09 - 6 | BRAUN Pince pour le col de l'utérus | 23 - 18 |

| | |
|--|-------------|
| BRAUN-STADLER Ciseaux à épisiotomie | 03 - 28 |
| BREISKY Speculum vaginal | 23 - 8 |
| BRODIE Sondes cannelées | 17 - 1 |
| BROPHY-SULLIVAN Fin ciseaux chirurgicaux | 03 - 17 |
| BROPHY Pince à dissection | 05 - 5 |
| BROPHY Pince à dissection à griffes | 05 - 11 |
| BROWN Pince à dissection à griffes | 05 - 13 |
| BROWN Porte-aiguille | 11 - 2 |
| BRUNNER | |
| Aiguilles à ligatures | 11 - 25 |
| Ecarteur | 13 - 24 |
| Pince intestinale | 21 - 8 |
| Sondes conductrices | 11 - 28 |
| BRUNNER-FERROZELL Sondes conductrices | 11 - 30 |
| BRUNS Ciseaux à bandes | 03 - 30 |
| BRUNS Curette tranchantes | 27 - 1 |
| BRYANT Pince à tampons | 07 - 3 |
| BUCK Ciseaux à ligatures | 03 - 19 |
| BUELAU Trocart | 17 - 6 |
| Bulldog clamps | 09 - 1 |
| Bulldog clamps, hémostatique | 09 - 2 |
| Bulldog clamps, vena | 09 - 2 |
| BUMM Curette | 23 - 30; 31 |
| BUNT Épingle de sécurité | 29 - 1 |
| BURKE Pince à biopsie | 23 - 34 |
| BUSCH Ciseaux à cordon ombilical | 03 - 28 |
| BYRD Tube d'aspiration | 17 - 10 |

C

| | |
|-----------------------------------|-----------------|
| Câble de traction | 17 - 4 |
| Cadenas con pesa | 15 - 24 |
| Cadre seul, rétracteur abdominal | 15 - 20; 21; 23 |
| CAMPBELL Trocart thorax | 17 - 7 |
| CAMPBELL Bougies urétrales | 19 - 10 |
| CANNY RYAL Ecarteur | 13 - 12 |
| Canule pour biopsie | 17 - 13 |
| Canule pour insufflation | 17 - 13 |
| Canule pour irrigation vasculaire | 17 - 14 |
| CAPLAN Ciseaux la cloison nasale | 03 - 20 |
| CARMALT Pince à échardes | 05 - 15 |
| CARREL Pince hémostatique | 09 - 5 |
| CARTILAGE Couteau à résection | 01 - 10 |
| CASTROVIEJO Porte aiguille | 11 - 21 |
| CASTROVIEJO Porte aiguille, Micro | 11 - 8 |
| CATLIN Couteau à amputation | 01 - 8 |
| CHAPUT Pince hémostatique | 09 - 3 |
| CHEATLE Pince à instruments | 29 - 1 |
| CHELSEA EATON Anuscope | 21 - 15 |
| CHERON Pince à tampons | 07 - 4 |
| CHILDE Pince à poser les agrafes | 11 - 32 |
| Ciseau-burin | 27 - 7-10 |

| | |
|----------------------------------|---------------------------------|
| Ciseaux, | |
| amygdales | 03 - 20; 21 |
| anatomie | 03 - 27 |
| bandes | 03 - 29; 30 |
| cartilage | 3 - 21; 24 |
| chirurgicaux | 03 - 1-5; 17; 32 |
| chirurgicaux, fin | 03 - 14; 16; 17 |
| cordon ombilical | 03 - 28 |
| dissection | 03 - 6-11; 13; 28; 34-36; 41-43 |
| dissection à griffes | 03 - 5; 6; 31; 32; 42 |
| dissection, fin | 03 - 9; 44 |
| dissection, micro | 03 - 46 |
| dure-mère | 03 - 20 |
| entérostomie | 03 - 26 |
| épisiotomie | 03 - 28 |
| face-lift | 03 - 41 |
| fils | 03 - 40 |
| fistules | 03 - 26 |
| gynécologie | 03 - 25; 26 |
| incision | 03 - 17 |
| intestinal | 03 - 24 |
| iridectomie | 03 - 15 |
| IRIS | 03 - 40; 43 |
| ligatures | 03 - 18; 19 |
| lobectomie | 03 - 27 |
| micro | 03 - 45-47; 51 |
| nasaux | 03 - 19; 20; 44 |
| neurochirurgie | 03 - 17; 18 |
| plastie du nez | 03 - 12; 13 |
| plâtre | 03 - 30 |
| préparation de nerfs | 03 - 13 |
| pulmonaires | 03 - 13 |
| rectale | 03 - 27 |
| strabisme | 03 - 14; 42 |
| tendineux | 03 - 14; 43; 45 |
| thoracique | 03 - 24 |
| utérins | 03 - 5; 23; 24; 32; 37 |
| vasculaires | 03 - 20; 22-24; 38; 39; 44 |
| vasculaires, micro | 03 - 51 |
| vasculaires et coronaires | 03 - 24 |
| vasculaires/thorax | 03 - 23 |
| Clamp bronche | 09 - 22; 25 |
| Clamp Bulldog | 09 - 1 |
| Clamp cardiovasculaire atrauma | 09 - 3 |
| Clamp pour les voies biliaires | 09 - 14; 21; 22 |
| Clamp pour instruments stériles' | 29 - 1 |

INDEX FRANÇAIS

| | | | |
|--|-------------|--|-------------------|
| CLAUS Aiguille ligatures | 11 - 27 | Curette | |
| CLAUS-EICKEN Aiguille ligatures | 11 - 27 | d'aspiration | 23 - 24 |
| CLOWARD Ecarteurs autostatiques | 15 - 12 | à avortement et placenta | 23 - 37; 38 |
| CLOWARD Modif. Ecarteurs autostatiques | 15 - 13 | double tranchante | 27 - 3 |
| CLOWARD Valve | 15 - 12; 13 | pour biopsie | 23 - 24 |
| COGSWELL Tube d'aspiration | 17 - 9 | pour calculs biliaires | 19 - 3; 4 |
| COHEN Intra-utérine bougie | 23 - 14 | pour les lupus | 25 - 1; |
| COLLIER Porte-aiguille | 11 - 1 | tranchantes | 27 - 1; 2; 3 |
| COLLIN | | utérine | 23 - 24; 26-32 |
| Bistouri à dissection | 01 - 6 | CUSCO Speculum vaginal | 23 - 2 |
| Couteau à amputation | 01 - 8 | CUSCO Speculum vaginal, Suisse | 23 - 2 |
| Ecarteur abdominal | 15 - 15 | CUSHING | |
| Hystéromètres | 23 - 23 | Ecarteurs sous forme de selle | 13 - 8 |
| Manche bistouris | 01 - 2 | Pince à dissection | 05 - 4 |
| Marteau | 27 - 11 | Pince à dissection à griffes | 05 - 11 |
| Pince à tampons | 07 - 4 | CUSHING-TAYLOR Pince à dissection | 05 - 20 |
| Pince hémostatique | 09 - 3 | Cuvettes | 29 - 2; 3 |
| Pince pour agrafes | 11 - 31 | CZERNY | |
| Pincés hysterolabes | 23 - 22 | Ecarteur | 13 - 12 |
| Speculum vaginal | 23 - 1 | Pince calculs biliaires | 19 - 2 |
| COLLIN-BABY Ecarteurs abdominal | 15 - 14 | Pince pour le col de l'utérus | 23 - 20 |
| COLLIN-DUVAL Pinças quirúrgicas | 05 - 12 | | |
| Compas pelvimètre | 23 - 38 | D | |
| Compresseur urétral | 19 - 10 | DANDY Ciseaux pour neurochirurgie | 03 - 18 |
| Cône grosse | 23 - 14 | DANDY Pince hémostatique | 09 - 9 |
| CONE Ecarteur | 15 - 7 | DARTIGUES Pince hysterolabe | 23 - 21 |
| CONTOUR Ecarteur | 15 - 2 | DAUBENSPECK Curette tranchantes | 27 - 2 |
| COOLEY Tube d'aspiration | 17 - 10 | DAVIDSON Ecarteur (scapula) | 13 - 27 |
| COOPER Aiguille ligatures | 11 - 24 | DAVIDSON Trocart | 17 - 6 |
| COPPELSON Pince à biopsie | 23 - 34 | DE BAKEY | |
| CORYLLOS Ecarteur | 13 - 23 | Bulldog clamp atrauma | 09 - 2 |
| COTTLE Ciseaux à nasaux | 03 - 20 | Ciseaux vasculaires | 03 - 23; 38 |
| COUPLAND Tube d'aspiration | 17 - 9 | Ecarteur | 15 - 9 |
| Couteau amputation | 01 - 8; 10 | Pince atrauma | 5 - 18 |
| Couteau autopsie | 01 - 9 | Porte-aiguilles | 11 - 13 |
| Couteau cerveau | 01 - 9 | Tube d'aspiration | 17 - 9 |
| Couteau interosseux | 01 - 9 | DE LA ROZA Aiguille ligatures | 11 - 26 |
| Couteau résection | 01 - 10 | DE LEE Forceps obstétriques | 23 - 35 |
| CRAFOORD-STELZNER Ciseaux intestinal | 03 - 24 | De MARTEL-WOLFSON | |
| CRAFOORD Pince hémostatique. | 09 - 11 | Pince pour fermer les clamps | 21 - 9 |
| CRAFOORD-SELLORS Clamp bronchial | 09 - 22 | Pinças-clamps pour anastomose intestinale | 21 - 9 |
| CRILE Pince hémostatique | 09 - 9 | Porte clamps | 21 - 9 |
| CRILE-RANKIN Pince hémostatique | 09 - 10 | DEAVER Ciseaux chirurgicaux | 03 - 2; 3 |
| CRILE-WOOD Porte-aiguille | 11 - 2 | DEAVER Ecarteur | 13 - 26; 27 |
| Crochet | | DENNIS-BROWN Ecarteur abdominal | 15 - 20 |
| à nerfs | 13 - 4 | Dépresseur utérin | 23 - 22 |
| à peau | 13 - 1 | DERF Porte-aiguille | 11 - 1; 10 |
| délicate | 13 - 1 | Dermatome | 01 - 11 |
| double | 13 - 2 | DESCHAMPS Aiguilles à ligatures | 11 - 23 |
| fin | 13 - 2 | DESJARDINS | |
| IRIS | 13 - 1 | Clamp pour les voies biliaires | 09 - 21 |
| pour dure-mère | 13 - 1 | Curettes pour calculs biliaires | 19 - 4 |
| pour la muqueuse | 13 - 1; 2 | Pince calculs biliaires | 19 - 1 |
| pour fistules | 23 - 25 | Sonde calculs biliaires | 19 - 4 |
| CUCHING Crochet à nerfs | 13 - 4 | | |

| | |
|---|------------------------|
| DESMARRES Ecarteur (paupière) | 13 - 7 |
| DESMARRES Ecarteurs sous forme de selle | 13 - 7 |
| DIEFFENBACH Bulldog clamps | 09 - 1 |
| DIEFFENBACH Bistouri à dissection | 01 - 7 |
| DIETHRICH Porte-aiguille, Micro | 11 - 10 |
| DIETHRICH Ciseaux vasculaires | 03 - 22; 38 |
| DIETHRICH-HEGEMANN Ciseaux vasculaires | 03 - 39 |
| Dilatateur utérin | 23 - 15; 16 |
| Dilatateur vesicale | 19 - 7 |
| Dilatateur vasculaire | 05 - 17 |
| Dilatateurs du col de l'utérus | 23 - 15; 17 |
| DISSECTING Bistouri à dissection | 01 - 7 |
| DITTEL Bougies urétrales | 19 - 9 |
| DOUGLAS Trocart et canule | 17 - 8 |
| DOYEN | |
| Ciseaux gynécologie | 03 - 25 |
| Ecarteur abdominal | 13 - 19 |
| Pince intestinale | 21 - 5 |
| Pince intestinale atrauma | 21 - 6 |
| Pince à polypes utérins | 23 - 21 |
| Rugine | 27 - 6 |
| Rugine costale | 27 - 6 |
| Sondes cannelées | 17 - 1 |
| Speculum vaginal | 23 - 7; 12 |
| Tracteur pour fibromes | 23 - 25 |
| DOYEN BABY Pince intestinale | 21 - 5 |
| DOYEN-STILLE Ecarteur | 13 - 20 |
| DUBOIS Ciseaux gynécologiques | 03 - 26 |
| DUEHRSEN Pince à dissection | 05 - 5 |
| DUEHRSEN Pince à dissection à griffes | 05 - 12 |
| DUPLAY Pince pour le col de l'utérus | 23 - 18 |
| DURANTE Pince à dissection à griffes | 05 - 12 |
| DUVAL Pince pour saisir intestins et tissus | 05 - 12; 21 - 4; 5 |
| É | |
| Ecarteur | 13 - 1; 3-6; 10-25 |
| (paupière) | 13 - 7 |
| (scapula) | 13 - 27 |
| à dissection à griffes | 15 - 10 |
| à ressort | 13 - 3 |
| abdominal | 13 - 19; 15 - 14-25 |
| autostatique | 15 - 1-13; 27 |
| des cotes | 15 - 26; 27 |
| mini | 13 - 5; 11 |
| pelvien | 13 - 27 |
| périnéal | 15 - 7 |
| prostatique | 19 - 8 |
| rectal | 21 - 12; 17 |
| sous forme de selle | 13 - 7-9 |
| vaginal | 15 - 10 |
| vésical | 19 - 6 |
| EISELSBERG Ciseaux à ligatures | 03 - 18 |
| Élévateur | 27 - 4; 5 |

| | |
|--|-------------|
| ELLIOT Forceps obstétriques | 23 - 36 |
| EMMET Crochets pour fistules | 23 - 25 |
| ENDARTERECTOMY Ciseaux à dissection | 03 - 42 |
| Endospeculums | 23 - 13 |
| ENGL. MOD. Pince à dissection | 05 - 4 |
| Épingle de sécurité | 29 - 1 |
| EPPENDORFER Pince à biopsie | 23 - 33 |
| ESMARCH Ciseaux à bandes | 03 - 30 |
| Etui d'instruments | 11 - 32 |
| Evideur de fibromes | 23 - 25 |
| F | |
| FALK Aiguille ligatures | 11 - 27 |
| FARABEUF Ecarteur | 13 - 10 |
| FARABEUF Rugine | 27 - 5 |
| FARREL Porte-coton | 17 - 3 |
| FAURE Pince à biopsie | 23 - 32 |
| FAURE Pincés à péritoine | 09 - 26 |
| FAVOLORO Ciseaux vasculaires | 03 - 23 |
| FEILCHENFELD Pince à échardes | 05 - 15 |
| FERGUSSON | |
| Ciseaux chirurgicaux | 03 - 17 |
| Angiotribe | 09 - 5 |
| Curettes pour calculs biliaires | 19 - 3 |
| Tube d'aspiration | 17 - 11 |
| FERRIS-SMITH Pincés à dissection à griffes | 05 - 5 |
| Fin ciseaux chirurgicaux | 03 - 15; 16 |
| Fin porte-coton | 17 - 3 |
| FINOCCHIETTO | |
| Ecarteurs des cotes | 15 - 26 |
| Lobectomie ciseaux | 03 - 27 |
| Clamp bronche | 09 - 22 |
| Porte-aiguilles | 11 - 4; 15 |
| FINSEN Ecarteur autostatique | 15 - 1 |
| Fixation châssis | 15 - 24 |
| FOERSTER Pince à éponges | 07 - 5 |
| FOMON Ciseaux à dissection | 03 - 6 |
| FOMON Ciseaux nasaux | 03 - 19 |
| Forceps obstétriques | 23 - 35; 36 |
| Fourchette pour ligatures en prof | 11 - 31 |
| FOX Curettes pour les lupus | 25 - 2 |
| FRANZ | |
| Cadre seul, rétracteur abdominal | 15 - 23 |
| Ecarteurs abdominal | 15 - 23 |
| Valve seul | 15 - 23 |
| FRAZIER Crochet pour dure-mère | 13 - 1 |
| FRAZIER Tube d'aspiration | 17 - 11 |
| FRITSCH Ecarteur | 13 - 19 |
| G | |
| GARLAND Pince à hystérectomie | 09 - 28 |
| GELPI Ecarteur périnéal | 15 - 7 |
| GEMINI Pince à dissection et ligature | 09 - 19 |
| GERALD Pince à dissection | 05 - 4 |
| GERALD Pince à dissection à griffes | 05 - 10 |

INDEX FRANÇAIS

| | | | |
|--|--|--------------------|--|
| GILLIES | | | |
| Crochet délicate | | 13 - 1 | |
| Pince à dissection à griffes | | 05 - 9; 20 | |
| Porte-aiguille | | 11 - 17 | |
| GIL-VERNET Ecarteurs sous forme de selle | | 13 - 9 | |
| GLASSMAN Pince intestinale | | 21 - 8 | |
| GLOVER Clamp cardiovasculaire atrauma | | 09 - 3 | |
| GOELET Ecarteur | | 13 - 12 | |
| GOMEL Porte-aiguille, micro | | 11 - 7 | |
| GOOD Ciseaux à amygdales | | 03 - 21 | |
| GOSSET Ecarteur abdominal | | 15 - 16 | |
| Gouge | | 27 - 7-10 | |
| GRAEFE Crochet (IRIS) | | 13 - 1 | |
| GRAEFE Pince à iris à dissection à griffes | | 05 - 7; 16 | |
| GRAVE Speculum vaginal | | 23 - 3 | |
| GRAY Clamp pour les voies biliaires | | 09 - 22 | |
| GRAZIL Ciseaux chirurgicaux | | 03 - 4 | |
| GREEN-ARMYTAGE Pince clamp utérines | | 23 - 37 | |
| GROSS-MAIER Pince à pansements | | 07 - 5 | |
| GUTHRIE Crochet double | | 13 - 2 | |
| GUYON | | | |
| Bougies urétrales | | 19 - 10 | |
| Pince à pédicule rénal | | 09 - 23 | |
| Atrauma pince amygdales à pédicule rénal | | 09 - 23 | |
| | | | |
| H | | | |
| HABERER Ecarteurs | | 15 - 25 | |
| HAIGHT Ecarteurs des cotes | | 15 - 27 | |
| HALLE Ciseaux nasaux | | 03 - 19 | |
| HALLE Curette tranchantes | | 27 - 2 | |
| HALSEY Porte-aiguille | | 11 - 11 | |
| HALSTED-MOSQUITO Pince hémostatique | | 09 - 7 | |
| HANK Dilatateur utérins | | 23 - 16 | |
| HARRINGTON Ecarteur | | 13 - 23 | |
| HARTMANN Pince hémostatique | | 09 - 6 | |
| HAYES Pince pour anastomose rectal | | 21 - 11 | |
| HEANEY Pince à hystérectomie | | 09 - 29 | |
| HEANEY Porte-aiguilles | | 11 - 4 | |
| HEANEY-BALLANTINE Pince à hystérectomie | | 09 - 28 | |
| HEANEY-KANTER Pince à hystérectomie | | 09 - 28 | |
| HEGAR Dilatateurs du col de l'utérus | | 23 - 15; 16 | |
| HEGAR Porte-aiguille | | 11 - 16 | |
| HEGAR-BAUMGARTNER Porte-aiguille | | 11 - 1 | |
| Hegemann ciseaux vasculaire | | 03 - 44 | |
| HEGEMANN-DIETHRICH Ciseaux vasculaire | | 03 - 22 | |
| HEGENBARTH Pince pour agrafes | | 11 - 31 | |
| HEISS Pince hémostatique | | 09 - 14 | |
| HENLY Ecarteur | | 15 - 11 | |
| HENLY Valve | | 15 - 11 | |
| HEPP-SCHIEDEL | | | |
| Porte-aiguille | | 11 - 20 | |
| Tube d'aspiration | | 17 - 10 | |
| Ciseaux, micro | | 03 - 45 | |
| | | | |
| HERRICK Pince à pédicule rénal | | 09 - 24 | |
| HESS Clamp Bulldog | | 09 - 1 | |
| HESSBERG Aiguille ligatures | | 11 - 26 | |
| HEYMANN Ciseaux à nasaux | | 03 - 20 | |
| HEYMANN Ciseaux à amygdales | | 03 - 20 | |
| HEYWOOD-SMITH Pince pour hémorroïdes | | 23 - 21 | |
| HIRSCHMANN Anuscope | | 21 - 14 | |
| HOSEMANN Pince hémostatique | | 09 - 21 | |
| HUMBY Dermatome | | 01 - 11 | |
| HUNTER Pince à échardes | | 05 - 15 | |
| HURD PALAIS Aiguille | | 11 - 27 | |
| HURWITZ Trocart | | 17 - 5 | |
| HYSTEREKTOMY Ciseaux à dissection | | 03 - 36 | |
| Hystéromètre | | 23 - 22; 23 | |
| | | | |
| I | | | |
| Instrument pince de long | | 29 - 1 | |
| Instrument de circoncision | | 19 - 10 | |
| Instruments chirurgicaux | | 11 - 32 | |
| Intra-utérine bougie | | 23 - 14 | |
| IOWA Aiguille pour anesthésie | | 17 - 12 | |
| IOWA Pince utérine | | 23 - 20 | |
| IRIS Fin ciseaux chirurgicaux | | 03 - 15 | |
| ISRAEL Ecarteur | | 13 - 14 | |
| IVES FANSLER Anuscope | | 21 - 15 | |
| | | | |
| J | | | |
| JABALEY Ciseaux à dissection à griffes | | 03 - 42 | |
| JACKSON Speculum vaginal | | 23 - 9 | |
| JACOBI Aiguille ligatures | | 11 - 26 | |
| JACOBS Pince utérine | | 23 - 19 | |
| JAMISON Ciseaux à dissection | | 03 - 42 | |
| JAMISON Porte-aiguilles | | 11 - 4 | |
| JANSEN | | | |
| Curette double | | 27 - 3 | |
| Curette tranchantes | | 27 - 3 | |
| Ecarteur | | 15 - 1 | |
| JARCHO Pince pour le col de l'utérus | | 23 - 18 | |
| JOBSON-HORNE Porte-coton | | 17 - 3 | |
| JOHNS-HOPKINS Clamps Bulldog | | 09 - 1 | |
| JOHNS-HOPKINS Pince hémostatique | | 09 - 15 | |
| JOLL (FRIEDMAN) Ecarteur vaginal | | 15 - 10 | |
| JONES Pince à champs | | 07 - 1 | |
| JOSEPH Ciseaux pour plastie du nez | | 03 - 13 | |
| JOSEPH Crochet pour la muqueuse | | 13 - 1 | |
| JUDD-ALLIS Pince pour saisir intestins et tissus | | 21 - 2 | |
| JUDD-MASSON, Ecarteur vesical | | 19 - 6 | |
| | | | |
| K | | | |
| KAHN Pince pour le col de l'utérus | | 23 - 18 | |
| KALLMORGEN Speculum vaginal | | 23 - 9 | |
| KALT Porte-aiguille, micro | | 11 - 10 | |
| KANTROWITZ Pince dissection et ligature/ligature | | 09 - 19 | |

| | | | |
|--|-----------|----------|--|
| KAYE | | | |
| Ciseaux pour face-lift | 03 | - 41 | |
| Ciseaux à fistules | 03 | - 26 | |
| Ecarteur | 13 | - 18 | |
| Pince hémostatique | 09 | - 8 | |
| Pincés à polypes utérins | 23 | - 21 | |
| Proctoscope | 21 | - 14 | |
| Pince à dissection et ligature | 09 | - 18 | |
| KELLY-RANKIN Pince hémostatique | 09 | - 8 | |
| KEVORKIAN Curette pour biopsie | 23 | - 24 | |
| KEVORKIAN-PACIFIC Pince à biopsie | 23 | - 34 | |
| KEVORKIAN-YOUNGE Pincés pour biopsie | 23 | - 33 | |
| KEYES Trépan | 25 | - 1 | |
| KIELLAND Forceps obstétriques | 23 | - 36 | |
| KIELLAND-LUIKART Forceps obstétriques | 23 | - 36 | |
| KILNER | | | |
| Ciseaux à dissection fin | 03 | - 44 | |
| Ciseaux pour plastie du nez | 03 | - 12 | |
| Crochet à peau | 13 | - 1 | |
| Porte aiguille | 11 | - 11 | |
| KIRSCHNER | | | |
| Cadre seul, rétracteur abdominal | 15 | - 21 | |
| Cadre, rétracteur abdominal | 15 | - 22 | |
| Ecarteurs abdominal | 15 | - 21 | |
| Sonde conductrice | 11 | - 30 | |
| Valve seul | 15 | - 21 | |
| KLEINERT-KUTZ Ecarteur | 13 | - 1 | |
| KLIMA-ROSSEGGER Aiguille pour ponction sternal | 17 | - 12 | |
| KLINKENBERGH LOTH Ciseaux thoracique | 03 | - 24 | |
| KNAPP Ecarteur | 13 | - 3 | |
| KNOWLES Ciseaux à bandage | 03 | - 30 | |
| KOCHER | | | |
| Aiguille ligatures | 11 | - 25 | |
| Ecarteur | 13 | - 20 | |
| Pince intestinale | 21 | - 6 | |
| Pince intestinale atrauma | 21 | - 7 | |
| Spatule à goitre | 11 | - 30 | |
| Spatule vésicale | 19 | - 8 | |
| KOCHER Délicate Pince hémostatique | 09 | - 12 | |
| KOCHER-LANGENBECK Ecarteur | 13 | - 16 | |
| KOENIG Sonde conductrice | 11 | - 29 | |
| KOERTE Ecarteur | 13 | - 14 | |
| KOGAN Endospeculums | 23 | - 13 | |
| KÖNIG Rugine | 27 | - 5 | |
| KRAUSE Trocart et canule | 17 | - 8 | |
| KRISTELLER Speculum vaginal | 23 | - 5; 6 | |
| KRISTELLER Valve vaginal | 23 | - 5 | |
| KROENLEIN Pince hémostatique | 09 | - 5 | |
| KRONECKER Aiguille ligatures | 11 | - 26 | |
| L | | | |
| LAHEY Clamp pour les voies biliaires | 09 | - 21 | |
| LAHEY Ecarteur | 13 | - 20 | |
| LAMBOTTE Osteotome | 27 | - 11 | |
| LAMBOTTE Rugine | 27 | - 5 | |
| Lame de bistouri stérile | 01 | - 5 | |
| Lame de rechange | 01 | - 11 | |
| Lame de rechange pour scie | 25 | - 3 | |
| LANDAU Speculum vaginal | 23 | - 11 | |
| LANDAU Trocart | 17 | - 6 | |
| LANDOLT Ciseaux fin | 03 | - 14 | |
| LANE | | | |
| Pince à champs | 07 | - 2 | |
| Pince à dissection à griffes | 05 | - 14 | |
| Pince clamp stomacale | 21 | - 10 | |
| Pince pour saisir intestins et tissus | 21 | - 2 | |
| LANGENBECK | | | |
| Amputation de couteaux | 01 | - 10 | |
| Ecarteur | 13 | - 15 | |
| Ecarteur, Mini | 13 | - 5 | |
| Élévateur | 27 | - 4; 9 | |
| Porte aiguille | 11 | - 20 | |
| LANGENBECK-GREEN Ecarteur | 13 | - 4 | |
| LAWRENCE Pincés à disséquer et à ligatures | 09 | - 21 | |
| LAWRENCE Porte aiguille | 11 | - 3 | |
| LEGUEU Spatule vésicale | 19 | - 8 | |
| LEGUEU Ecarteur vésical | 19 | - 6 | |
| LEMPERT Curette tranchantes | 27 | - 2 | |
| LERICHE Pince hémostatique | 09 | - 9 | |
| LERMOYER Trocart thorax | 17 | - 7 | |
| LEXER Ciseaux à dissection | 03 | - 11; 32 | |
| LEXER-BABY Ciseaux à dissection | 03 | - 11 | |
| LICHTENBERG Porte-aiguille | 11 | - 6; 19 | |
| LICHTWITZ Trocart sinus maxille | 17 | - 8 | |
| Ligator pour hémorroïdes | 21 | - 16 | |
| LINCOLN Ciseaux vasculaire | 03 | - 20 | |
| LISTER (sinus) Pince à tampons | 07 | - 3 | |
| LISTER Ciseaux à bandages | 03 | - 29 | |
| LISTER-EXCENTRIC Ciseaux à bandage | 03 | - 29 | |
| LISTON Couteau à amputation | 01 | - 8 | |
| LITTAUER Ciseaux à ligatures | 3 | - 19 | |
| LITTLE Ecarteur | 13 | - 21 | |
| LITTLE-WOOD Pince pour saisir intestins et tissus | 21 | - 2 | |
| L'laves | 17 | - 16 | |
| LLOYD-DAVIES Ciseaux à entérostomie | 03 | - 26 | |
| LOCKHART-MUMMERY Sonde | 17 | - 2 | |
| LOCKWOOD-ALLIS Pince pour saisir intestins et tissus | 21 | - 2 | |
| LOCKWOOD Pince pour saisir intestins et tissus | 21 | - 3 | |
| LONG Pince à hystérectomie | 09 | - 28 | |
| LORENZ Ciseaux à bandes | 03 | - 30 | |
| LORNA Pince à champs | 07 | - 2 | |
| LOVELACE Pince à poumon | 09 | - 24 | |
| LOVELACE Pince hemostatatique à dissection à griffes | 09 | - 10 | |
| LOVELACE Pince hémostatique à dissection | 09 | - 10 | |
| LOWER Pince à disséquer et à ligatures | 09 | - 21 | |
| LUER-KOERTE curettes pour calculs biliaires | 19 | - 3 | |
| LUER-LOCK Aiguilles spéciales | 17 | - 12 | |

INDEX FRANÇAIS

M

| | | | |
|--|--------------------|--|--|
| M.G.H. Porte aiguille | 11 - 2 | | |
| MAGILL Mandrin pour tube d'aspiration | 17 - 10 | | |
| Maillet | 27 - 11 | | |
| MAINGOT Pincés à hystérectomie | 09 - 27 | | |
| Manche de bistouris | 01 - 1; 2 | | |
| Mandrin tube d'aspiration | 17 - 10 | | |
| Marteau | 27 - 11 | | |
| MARTEL Pince pour le cuir chevelu | 09 - 4 | | |
| MARTIN | | | |
| Compas pelvimètre | 23 - 38 | | |
| Pincés à hystérectomie | 23 - 23 | | |
| Curette double | 27 - 3 | | |
| MASSON Porte-aiguilles | 11 - 15 | | |
| MATHIEU | | | |
| Ecarteur | 13 - 11 | | |
| Pince à corps étranger | 19 - 7 | | |
| Porte-aiguille | 11 - 6; 19 | | |
| Speculum rectal | 21 - 12 | | |
| Speculum vaginal | 23 - 11 | | |
| MATHIEU-KOCHER Porte-aiguille | 11 - 7 | | |
| MATHIEU-KOCHER Porte-aiguille fin | 11 - 18 | | |
| MATZNAUER Speculum vaginal | 23 - 12 | | |
| MAYO | | | |
| Ciseaux à dissection | 03 - 41 | | |
| Ciseaux à dissection à griffes | 03 - 5 | | |
| Ciseaux utérins | 03 - 5; 32 | | |
| Clamps pour instruments stériles | 29 - 1 | | |
| Curettes pour calculs biliaires | 19 - 3 | | |
| Sonde à calculs biliaires | 19 - 4 | | |
| MAYO-ADAMS Ecarteur | 15 - 4 | | |
| MAYO-BLAKE Pince à calculs biliaires | 19 - 1 | | |
| MAYO-HEGAR Porte-aiguille | 11 - 3; 12 | | |
| MAYO-NOBLE Ciseaux à dissection | 03 - 6 | | |
| MAYO-ROBSON Pince intestinale | 21 - 7 | | |
| MAYO-STILLE Ciseaux à dissection à griffes | 03 - 6; 32 | | |
| MC DONALD Elévateur double | 27 - 4 | | |
| MC GIVNEY Ligatur pour hémorroïdes | 21 - 16 | | |
| MC INDOE | | | |
| Ciseaux à cartilages | 03 - 24 | | |
| Pince à dissection | 05 - 3; 20 | | |
| Pince à dissection à griffes | 05 - 10 | | |
| MC LEAN Forceps obstétriques | 23 - 36 | | |
| MC QUIGG-MIXTER Pince à dissection et ligature | 09 - 22 | | |
| MEEKER Pince à disséquer et à ligatures | 09 - 20 | | |
| MENGHINI Aiguille à biopsie | 17 - 15 | | |
| MENGHINI Trocart pour aiguille ponction | 17 - 15 | | |
| METZENBAUM | | | |
| Ciseaux à dissection | 03 - 8; 33; 41 | | |
| Delicate ciseaux à dissection | 03 - 9; 34; 35 | | |
| Porte-aiguille | 11 - 2 | | |
| METZENBAUM-BABY Ciseaux à dissection | 03 - 7; 43 | | |
| METZENBAUM-FINO Ciseaux à dissection | 03 - 10; 34-36; 41 | | |
| METZENBAUM-LAHEY Ciseaux à dissection | 03 - 35 | | |
| METZENBAUM-NELSON Ciseaux à dissection | 03 - 8; 41 | | |
| MEYERDING Ecarteur | 13 - 5 | | |
| MICHEL | | | |
| Agrafes | 11 - 32 | | |
| Instruments chirurgicaux | 11 - 32 | | |
| Pince à poser les agrafes | 11 - 31; 32 | | |
| Micro-ADSON | | | |
| Pince à dissection | 05 - 8; 9; 20 | | |
| Pince à dissection à griffes | 05 - 3; 20 | | |
| Pince à dissection et ligature | 09 - 15 | | |
| Micro-MOSQUITO Pince hémostatique | 09 - 8 | | |
| MIDDELDORPF Ecarteur | 13 - 18 | | |
| MIKULICZ | | | |
| Pince à péritoine | 09 - 25 | | |
| Ecarteur | 13 - 22 | | |
| Pince pour anastomose rectal | 21 - 11 | | |
| MIKULICZ-BABY Pince à péritoine | 09 - 25 | | |
| MILAN Curette pour biopsie | 23 - 24 | | |
| MILLIGAN Ecarteur | 15 - 6 | | |
| MILLIN | | | |
| Dilatateur vésicale | 19 - 7 | | |
| Ecarteur vésical | 19 - 6 | | |
| Pince porte-fil | 19 - 7 | | |
| Pince pour saisir les capsules et prostatectomie rétropubienne | 19 - 7 | | |
| Pince pour saisir les capsules atraumatique | 19 - 7 | | |
| Pince pour saisir les lambeaux antérieurs | 19 - 7 | | |
| MIXTER | | | |
| Ciseaux à dissection | 03 - 11 | | |
| Pince à calculs biliaires | 19 - 1 | | |
| Pincés à disséquer et à ligatures | 09 - 20; 21 | | |
| MIXTER-BABY Pince passe-fil | 09 - 6 | | |
| MIXTER-O'SHAUGNESSY Pincés à disséquer et à ligatures | 09 - 20 | | |
| MOCK Aiguilles spéciales | 17 - 12 | | |
| MOD. BONN Fin ciseaux chirurgicaux | 03 - 16 | | |
| MOD. USA Ciseaux à dissection | 03 - 28 | | |
| MOD. WIEN Attrape-fil | 11 - 31 | | |
| MOLLISON Ecarteur | 15 - 3 | | |
| MOORE Curettes pour calculs biliaires | 19 - 4 | | |
| MORGAN Proctoscope | 21 - 15 | | |
| MORRIS Ecarteur | 13 - 22 | | |
| MOYNIHAN Pince clamp mors courts | 09 - 27 | | |
| MOYNIHAN Sonde à calculs biliaires | 019 - 3 | | |
| MUSEUX Pince pour le col de l'utérus | 23 - 20 | | |
| N | | | |
| NABATOFF | | | |
| Câble de traction | 17 - 4 | | |
| Olive | 17 - 4 | | |
| Poignée seule | 17 - 4 | | |
| Pointe de sonde seule | 17 - 4 | | |
| Trousse à varices | 17 - 4 | | |
| NAEGELE Forceps obstétriques | 23 - 36 | | |
| NAGER Aiguille ligatures | 11 - 27 | | |

| | |
|---|---------|
| NEGUS Clamp pour les voies biliaires | 09 - 14 |
| NEIVERT Porte-aiguille | 11 - 1 |
| NELATON Sondes cannelées | 17 - 1 |
| NELSON Pincés á dissection á griffes | 05 - 12 |
| NELSON Trocart thorax | 17 - 7 |
| NORFOLK-NORWICH Ecarteur á dissection á griffes | 15 - 10 |
| NORTHBENT(SPENCER) Ciseaux á ligatures | 03 - 18 |
| NOTO Pincés á polypes utérins | 23 - 21 |
| NOVAK Curette d'aspiration | 23 - 24 |

O

| | |
|--|---------------|
| Obstétriques | 23 - 35 |
| OCHSNER Trocart thorax | 17 - 7 |
| OCHSNER Sonde calculs biliaires | 19 - 4 |
| OCHSNER-KOCHER Pince hémostatique | 09 - 13 |
| O'CONNOR Crochet muqueuse | 13 - 1 |
| Olive | 17 - 9; 14 |
| OLSEN HEGAR Porte-aiguille | 11 - 17 |
| Ostéotome | 27 - 7; 8; 11 |
| Ostéotome, mini | 27 - 11 |
| O'SULLIVAN-O'CONNORI | |
| Ecarteur abdominal | 15 - 20 |
| Cadre seul, rétracteur abdominal | 15 - 20 |
| Valve | 15 - 20 |
| OVERHOLT GEISSENDOERFER Pince á disséquer et á ligatures | 09 - 17 |
| OVERHOLT Pince á disséquer et á ligatures | 09 - 16 |
| OVERHOLT-MIXTER Pince á disséquer et á ligatures | 09 - 15 |

P

| | |
|--|-------------|
| PALAIS Aiguille | 11 - 27 |
| PARKER Ecarteur | 13 - 11 |
| PARKER-LANGENBECK Ecarteur | 13 - 12 |
| PARTSCH | |
| Ciseau-burin | 27 - 7 |
| Gouge | 27 - 8 |
| Marteau | 27 - 11 |
| PAYR Pincés-clamps intestinales | 21 - 9 |
| PAYR Sonde conductrice | 11 - 29 |
| PEAN Pince hémostatique | 09 - 6 |
| PEAN Pince hémostatique Délicate | 09 - 12 |
| PEDERSON Speculum vaginal | 23 - 3 |
| PEERS Pince á champs | 07 - 3 |
| PELKMANN Pince á tampons | 07 - 4 |
| PENNINGTON Pince hémostatique | 09 - 4 |
| Perforateur á ongles | 25 - 1 |
| PERFORATEUR D'UTÉRUS | 23 - 25 |
| PESTALOZZA Curettes á avortement et placenta | 23 - 37 |
| PHANEUF Pince á péritoine | 09 - 26 |
| PIERCE Trocart sinus maxille | 17 - 7 |
| Pièces de connexion | 17 - 16; 17 |
| PIFFARD Curettes pour les lupus | 25 - 1 |

Pince

| | |
|-------------------------------------|-----------------------|
| á biopsie | 23 - 32-34 |
| á calculs biliaires | 19 - 1 |
| á champs | 07 - 1-3 |
| á corps étranger | 19 - 7 |
| á dissection | 05 - 1; 3-5; 19; 20 |
| á dissection á griffes | 05 - 6-13; 20 |
| á dissection á griffes, micro | 05 - 8 |
| á dissection á rugine | 05 - 3 |
| á dissection et ligature | 09 - 15; 18-22 |
| á dissection, micro | 5 - 3; 20 |
| á disséquer et á ligatures | 09 - 10; 15-17; 19-21 |
| á échardes | 05 - 14; 15 |
| á éponges | 07 - 5 |
| á extraire ongles | 25 - 3 |
| á hystérectomie | 09 - 27-29; 23 - 23 |
| á instruments | 29 - 1 |
| á IRIS á dissection á griffes | 05 - 7; 16 |
| á pansements | 07 - 5 |
| á pédicule rénal | 09 - 23; 24 |
| á péritoine | 09 - 25; 26 |
| á polypes utérins | 15 - 24; 23 - 21 |
| á poser clamps Bulldog | 09 - 1 |
| á poser les agrafes | 11 - 31; 32 |
| á poumon | 09 - 24 |
| á stérilisation | 29 - 1 |
| á tampons | 07 - 3; 4 |
| amygdales á pédicule rénal | 09 - 23 |
| amygdalienne | 09 - 11 |
| calculs biliaires | 19 - 1; 2 |
| calculs rénaux | 19 - 1 |
| clamp á bronches | 9 - 24; 25 |
| clamp bronchique | 09 - 14 |
| clamp mors courts | 09 - 27 |
| clamp stomacale | 21 - 10 |
| clamp utérines | 23 - 37 |
| d'horloger | 05 - 17 |
| dissection et ligature | 09 - 19; 20 |
| hémostatique | 09 - 3-15; 18; 21 |
| hémostatique á dissection | 09 - 10 |
| hémostatique á dissection á griffes | 09 - 10 |
| hémostatique artères | 09 - 12; 15 |
| hémostatique atrauma | 09 - 4 |
| hystérectomie | 9 - 26; 27; 23 - 23 |
| hysterolabe | 23 - 21; 22 |
| intestinale | 21 - 1; 2; 5-8; 10 |
| intestinale atrauma | 21 - 1; 4; 6; 7 |
| micro | 05 - 15 |
| modèle russe | 05 - 11 |
| passé-fil | 09 - 6 |

INDEX FRANÇAIS

| | | | |
|---|-------------------------------|--|--|
| Pince | | | |
| hémostatique délicate | 09 - 12 | | |
| péritoine | 09 - 26 | | |
| placentaires et pour poste arboretum | 23 - 37; 38 | | |
| polypes utérins | 23 - 21 | | |
| porte-fil | 19 - 7 | | |
| pour abaissement du col col | 23 - 18 | | |
| pour agrafes | 11 - 31 | | |
| pour anastomose rectal | 21 - 11 | | |
| pour biopsie | 23 - 32-34 | | |
| pour biopsie rectal | 21 - 16 | | |
| pour calculs biliaires | 19 - 2 | | |
| pour extraire les ongles | 25 - 3 | | |
| pour fermer les clamps | 21 - 9 | | |
| pour fils | 11 - 16 | | |
| pour hémorroïdes | 21 - 17; 23 - 21 | | |
| pour le col de l'utérus | 23 - 17-20 | | |
| pour le cuir chevelu | 09 - 4 | | |
| pour saisir intestins et tissus | 05 - 12; 21 - 3-5 | | |
| pour saisir les capsules, atraumatique | 19 - 7 | | |
| pour saisir les capsules, et prostatectomie rétropubienne | 19 - 7 | | |
| pour saisir les lambeaux antérieurs | 19 - 7 | | |
| presse-tubes | 07 - 6 | | |
| quirurgicas | 05 - 12 | | |
| standarte | 05 - 7 | | |
| tangentielle | 09 - 24 | | |
| thoracique | 09 - 16 | | |
| USA à dissection | 05 - 2 | | |
| USA à dissection à griffes | 05 - 8 | | |
| utérine | 23 - 17; 19; 20 | | |
| utérines | 23 - 34 | | |
| Pincés-clamps intestinales | 21 - 9 | | |
| Pincés-clamps pour anastomose intestinale | 21 - 9 | | |
| PIPER Forceps obstétriques | 23 - 36 | | |
| Plaque pour étendre la peau | 01 - 10 | | |
| PLESTER Ecarteur | 15 - 6 | | |
| Poignée seule | 17 - 4 | | |
| Pointe de sonde seule | 17 - 4 | | |
| POOLE Tube d'aspiration | 17 - 8 | | |
| POPPE-FERGUSSON Tube d'aspiration | 17 - 11 | | |
| Porte-aiguille | 11 - 1-7; 10-17; 19-21; 26 | | |
| Porte-aiguille, fin | 11 - 6; 18 | | |
| Porte-aiguille, micro | 11 - 7-10 | | |
| Porte-aiguilles | 11 - 4; 14; 15 | | |
| Porte-clamps | 21 - 9 | | |
| Porte-coton | 17 - 3 | | |
| POTTS DE MARTEL Ciseaux vasculaire | 03 - 22; 38 | | |
| POTTS-SMITH | | | |
| Anatomie ciseaux | 03 - 27 | | |
| Ciseaux vasculaire | 03 - 23; 39 | | |
| Pince à dissection | 05 - 4; 20 | | |
| Pince à dissection à griffes | 05 - 11 | | |
| POZZI Pince pour abaissement. Du col | 23 - 18 | | |
| PRATT | | | |
| Cystikus ecarteur | 21 - 17 | | |
| Dilatateurs du col de l'utérus | 23 - 16 | | |
| Pince hémostatique | 09 - 5 | | |
| Pince utérine | 23 - 20 | | |
| PRESBYTERIAN Pince presse-tubes | 07 - 6 | | |
| PRICE-THOMAS Pince clamp à bronches | 9 - 24; 25 | | |
| PRINCE Ciseaux à amygdales | 03 - 21 | | |
| Proctoscope | 21 - 14; 15 | | |
| PROVIDENCE-HOSPITAL Pince hémostatique | 09 - 7 | | |
| PYE-SMITH-HARRISON Pince à stériliser | 29 - 1 | | |
| QUINKE aiguille pour ponction lombaire | 17 - 15 | | |
| R | | | |
| RADOLF Pince à extraire ongles | 25 - 3 | | |
| RAGNELL-DAVIS Ecarteur double | 13 - 6 | | |
| RAMPLEY Pince à éponges | 7 - 5 | | |
| RANDALL Curette à aspiration | 23 - 24 | | |
| RANDALL Pince calculs rénaux | 19 - 1 | | |
| RECAMIER Curette utérines | 23 - 26; 28 | | |
| Récipients en métal | 29 - 2 | | |
| Rectale ciseaux | 03 - 27 | | |
| Ressort bouchon filète. | 17 - 16 | | |
| Rétracter latérale vaginale | 23 - 14 | | |
| Rétracteur thoracique | 13 - 4 | | |
| REVERDIN Aiguille | 11 - 22 | | |
| REVERDIN Ecarteur abdominal | 15 - 25 | | |
| REYNOLDS Ciseaux à dissection | 3 - 43 | | |
| RIBBON Ecarteur | 15 - 25 | | |
| RICARD Ecarteurs abdominaux | 15 - 14 | | |
| RICHARDSON Ecarteur | 13 - 18 | | |
| RICHARDSON-EASTMAN Ecarteur | 13 - 19 | | |
| RICHTER Ecarteur | 15 - 10 | | |
| RICHTER-HEATH Pince pour agrafes | 11 - 31 | | |
| ROBERTS Pince hémostatique | 09 - 14 | | |
| ROBIN-MASSE Ecarteur abdominal | 15 - 15 | | |
| ROBIN-MASSE Valve latérale | 15 - 15 | | |
| ROCHARD Ecarteurs abdominaux | 15 - 24 | | |
| ROCHARD Fixation châssis | 15 - 24 | | |
| ROCHESTER-CARMALT Pince hémostatique | 09 - 12 | | |
| ROCHESTER-PEAN Pince hémostatique | 09 - 13 | | |
| ROEDER Pince à champs | 07 - 1 | | |
| ROGGE Pince à stérilisation | 29 - 1 | | |
| ROUX Ecarteur | 13 - 10 | | |
| ROUX Ecarteur, mini | 13 - 11 | | |
| ROUX-BABY Ecarteur | 13 - 11 | | |
| RUDD Ligatur pour hémorroïdes | 21 - 16 | | |
| RUDD Pince pour hémorroïdes | 21 - 17 | | |
| Rugine | 27 - 5; 6 | | |
| Rugine costale | 27 - 6 | | |
| RUMEL Pince thoracique | 09 - 16 | | |
| RYDER Porte-aiguilles | 11 - 14 | | |
| RYDER Vasculaire porte-aiguille | 11 - 13 | | |

S

| | |
|--|-------------|
| SAALFELD Tire-comédons | 25 - 2 |
| SAENGER Pince placentaires et pour poste arboretum | 23 - 37; 38 |
| SANVENERO Ciseaux à dissection | 03 - 13 |
| SAROT Pince clamp bronchique | 09 - 14 |
| SAROT Porte-aiguille | 11 - 11 |
| SATISKY Ciseaux vasculaire | 03 - 24 |
| SAUERBRUCH Ecarteur | 13 - 17 |
| SCHAMBERG Tire-comédons | 25 - 2 |
| SCHEDE Curette tranchantes | 27 - 1 |
| SCHERBAK Speculum vaginal | 23 - 4 |
| SCHINK Dermatome | 01 - 11 |
| SCHINK plaque pour étendre la peau | 01 - 10 |
| SCHMID Canule pour irrigation vasculaire | 17 - 14 |
| SCHMIEDEN Aiguille ligatures | 11 - 25 |
| SCHMIEDEN Sonde conductrice | 11 - 29 |
| SCHMIEDEN-PAYR Sonde conductrice | 11 - 29 |
| SCHMIEDEN-TAYLOR Ciseaux dure-mère | 03 - 20 |
| SCHNIDT-SAWTELL Pince amygdalienne | 09 - 11 |
| SCHROEDER Pince utérine | 23 - 18 |
| SCHUBERT Pince à biopsie | 23 - 33 |
| SCHUKNECHT Ecarteur | 15 - 3 |
| SCHUMACHER Ciseaux à cordon ombilical | 03 - 28 |
| SCHUMACHER Pince à biopsie | 23 - 33 |
| SCHUMACHER-VAN DOREN Pinces pour biopsie | 23 - 32 |
| SCHWED. MOD. Vasculaire porte-aiguille | 11 - 14 |
| Scie pour couper les bagues | 25 - 3 |
| SCUDDER Pince intestinale | 21 - 10 |
| SEDILLOT Rugine | 27 - 6 |
| SEGOND Evideur de fibromes | 23 - 25 |
| SELDINGER Locke, canule pour biopsie | 17 - 13 |
| SELETZ-GELPI Ecarteur périnéal | 15 - 7 |
| SEMB Clamp bronches | 09 - 25 |
| SEMKEN Pince à dissection | 05 - 4 |
| SEMKEN Pince à dissection à griffes | 05 - 10 |
| SEMM | |
| Cadre seul, rétracteur abdominal | 15 - 23 |
| Speculum vagina | 23 - 3 |
| Valve | 15 - 23 |
| SENN Ecarteur | 13 - 6 |
| SENN-GREEN Ecarteur | 13 - 5 |
| SENN-MILLER-BABY Ecarteur | 13 - 6 |
| SHORTBENT Ciseaux à ligatures | 03 - 18 |
| SIEBOLD Ciseaux gynécologues | 03 - 25 |
| SILVER Dermatome | 01 - 11 |
| SIMON | |
| Crochets pour fistules | 23 - 25 |
| Cuiller utérine | 23 - 32 |
| Ecarteur abdominal | 13 - 21 |
| SIMPSON Hystéromètre | 23 - 23 |
| SIMPSON-BRAUN Forceps obstétriques | 23 - 35 |
| SIMPSON-LUIKART Forceps obstétriques | 23 - 35 |

SIMS

| | |
|--|--------------|
| Ciseaux à utérins | 03 - 37 |
| Curette utérines | 23 - 27; 29 |
| Dépresseur utérin | 23 - 22 |
| Hystéromètre | 23 - 22 |
| Sonde hystéromètre | 23 - 22 |
| Speculum rectal | 21 - 12 |
| Speculum vaginal | 23 - 10; 11 |
| SINGLEY-TUTTLE Pinces à dissection à griffes | 05 - 5 |
| SKENE Pince pour le col de l'utérus | 23 - 19 |
| SMITH-BUIE Ecarteur rectal | 21 - 12 |
| SMITH-PETERSEN Ciseau-burin | 27 - 10 |
| SMITH-PETERSEN Gouge | 27 - 10 |
| SÖKELAND Pince calculs biliaires | 19 - 2 |
| SOMER Pince hysterolabe | 23 - 21 |
| Sonde | |
| à calculs biliaires | 19 - 3; 4; 5 |
| auriculaire | 17 - 1 |
| boutonne | 17 - 1; 2 |
| cannelée | 17 - 1; 2 |
| conductrice | 11 - 28-30 |
| feuille myrthe | 17 - 1 |
| feuille myrthe boutonné | 17 - 2 |
| hystéromètre | 23 - 22 |
| métal | 19 - 9 |
| Spatule à goitre | 11 - 30 |
| Spatule pulmonaire | 13 - 27 |
| Spatule vésicale | 19 - 8 |
| Speculum rectal | 21 - 12; 13 |
| Speculum vaginal | 23 - 1-12 |
| SPENCER Ciseaux à ligatures | 03 - 19 |
| SPENCER-WELLS Pince hémostatique | 09 - 6 |
| ST.MARKS Ecarteur pelvien | 13 - 27 |
| STACKE Sonde auriculaire | 17 - 1 |
| STAUDE-MOORE Pince pour le col de l'utérus | 23 - 17 |
| STELZNER Lobectomie et rectale ciseaux | 03 - 27 |
| STEVENS Ciseaux à tendineux | 03 - 14 |
| STEVENS Ciseaux, micro | 03 - 47 |
| STILLE | |
| Ciseau-burin | 27 - 8 |
| Gouge | 27 - 9 |
| Osteotome | 27 - 8 |
| Pince à dissection | 05 - 3 |
| Pince à dissection à griffes | 05 - 9 |
| Pince à pédicule rénal | 09 - 23 |
| STOCKMANN Compresseur urétral | 19 - 10 |
| STRABISMUS Ciseaux | 03 - 42 |
| STRATTE Porte-aiguille | 11 - 5; 17 |
| STRAUSS Compresseur urétral | 19 - 10 |
| STRULLY Ciseaux neurochirurgie | 03 - 18 |
| SYME Aiguille ligatures | 11 - 24 |

T

| | |
|---|-------------|
| Tamis | 23 - 15; 16 |
| TAYLOR | |
| Pince à dissection | 05 - 3 |
| Pince à dissection à griffes | 05 - 10 |
| Pince à dissection à rugine | 05 - 3 |
| TEALE Pince pour le col de l'utérus | 23 - 19 |
| TERRIER Pince hémostatique | 09 - 5 |
| THOMS-ALLIS Pince pour saisir intestins et tissus | 21 - 3 |
| THOMS-GAYLOR Pince à biopsie | 23 - 32; 33 |
| THOMSON-WALKER Ecarteur vésical | 19 - 6 |
| THOREK Ciseaux pulmonaires | 03 - 13 |
| Tire-comédons | 25 - 2 |
| TISCHLER-KEVORKIAN Pince à biopsie | 23 - 34 |
| TISCHLER-MORGAN Pince à biopsie. | 23 - 34 |
| TOENNIS Pince hémostatique | 09 - 18 |
| TOENNIS Porte-aiguille | 11 - 17 |
| TOENNIS-ADSON | |
| Ciseaux à dissection | 03 - 10 |
| Ciseaux fin | 03 - 35 |
| Ciseaux neurochirurgie | 03 - 17 |
| TOHOKU Pince à champs | 07 - 3 |
| Tords-fil | 11 - 31 |
| TOWNSEND Mini Pinces pour biopsie | 23 - 34 |
| Tracteur pour fibromes | 23 - 25 |
| TRELAT Aiguille ligatures | 11 - 27 |
| Trépan | 25 - 1 |
| TREVES Pince à dissection à griffes | 05 - 13 |
| Trocart abdominal | 17 - 5; 6 |
| Trocart et canule | 17 - 8 |
| Trocart pour aiguille ponction | 17 - 15 |
| Trocart sinus maxille | 17 - 7; 8 |
| Trocart thorax | 17 - 7 |
| Trousse à varices | 17 - 4 |
| Tube d'aspiration | 17 - 8-11 |
| TUFFIER Ecarteurs des cotes | 15 - 26 |
| TUFFIER Pince hémostatique | 09 - 3 |
| TUOHY Aiguille pour ponction lombaire | 17 - 15 |
| TURNER-WARWICK Modif. Ecarteurs abdominal | 15 - 19 |
| TURNER-WARWICK Pince calculs biliaires | 19 - 2 |

U

| | |
|-----------------------------------|---------|
| UCKERMANN Porte-coton | 17 - 3 |
| ULRICH Pince à tampons | 07 - 4 |
| Universal ciseaux à fils | 03 - 29 |
| Universal trocart | 17 - 5 |
| UNNA Tire-comédons | 25 - 2 |
| URO-TANGENTIAL Pince tangentielle | 09 - 24 |
| US Army Ecarteur | 13 - 12 |

V

| | |
|----------------------|--|
| VALLEIX hystéromètre | 23 - 23 |
| Valve | 5 - 11-13; 15; 18; 20; 22; 23; 19 - 6; 21 - 13 |
| Valve intestin | 15 - 23 |

| | |
|---------------------------------|-----------------|
| Valve interchangeable | 15 - 14 |
| Valve seul | 15 - 20; 21; 23 |
| Valve vaginale | 23 - 5 |
| Vasculaire porte-aiguille | 11 - 13; 14 |
| VAN BUREN Bougie dilatateur | 19 - 9 |
| VERESS Canule pour insufflation | 17 - 13 |
| VIRCHOW Couteau à cerveau | 01 - 9 |
| VOLKMANN | |
| Curette double tranchante | 27 - 3 |
| Curette tranchantes | 27 - 1 |
| Ecarteur | 13 - 13 |

W

| | |
|---|------------|
| WACHENFELDT Pince à poser les agrafes | 11 - 31 |
| WAGNER Ciseaux fin | 03 - 14 |
| WALB Couteau à autopsie | 01 - 9 |
| WALDMANN Ciseaux à épisiotomie | 03 - 28 |
| WALLICH Curettes à avortement et placenta | 23 - 38 |
| WALTON Tire-comédons | 25 - 2 |
| WANGENSTEEN Pince à dissection | 05 - 19 |
| WANGENSTEEN Porte-aiguilles | 11 - 4; 15 |
| WATSON-CHEYNE Elévateur | 27 - 4 |
| WAUGH Pince à dissection à griffes | 5 - 11 |
| WAUGH Pince à dissection | 05 - 5 |
| WEBSTER Porte-aiguille | 11 - 10 |
| WEISSBARTH Speculums vaginal | 23 - 3 |
| WEITLANER Ecarteur | 15 - 5 |
| WEITLANER-BABY Ecarteur | 15 - 7 |
| WEITLANER-LOKTITE Ecarteur | 15 - 5 |
| WERTHEIM Pince hystérectomie | 09 - 27 |
| WERTHEIM Speculum vaginal | 23 - 12 |
| WERTHEIM-CULLEN Pinces à hystérectomie | 09 - 27 |
| WESTCOTT Ciseaux à tendineux | 03 - 45 |
| WIKSTROEM Pince à disséquer et à ligatures | 09 - 19 |
| WILLAUER Lobectomie et rectale ciseaux | 03 - 27 |
| WILLET-MARTEL Pince pour le cuir chevelu | 09 - 4 |
| WILLIAMS Pince pour saisir intestins et tissus | 21 - 3 |
| WILLIGER | |
| Curette double | 27 - 3 |
| Curette tranchantes | 27 - 3 |
| Elévateur | 27 - 4 |
| Rugine | 27 - 6 |
| WINTER Pince placentaires et pour poste arborétum | 23 - 37 |
| WITTNER Pince à biopsie | 23 - 33 |
| WRIGLEY Forceps obstétriques | 23 - 35 |
| WULLSTEIN Ecarteur | 15 - 3 |

Y

| | |
|----------------------------------|---------|
| YANKAUER Tube d'aspiration | 17 - 9 |
| YEOMAN Pince pour biopsie rectal | 21 - 16 |
| YOUNG Boomerang porte-aiguille | 11 - 26 |
| YOUNG Ecarteur prostatique | 19 - 8 |

Z

| | |
|-------------------------------------|---------|
| ZENKER Ecarteur | 13 - 23 |
| ZENKER Pince dissection et ligature | 09 - 20 |
| ZWEIFEL Porte-aiguille | 11 - 20 |

INDICE ESPAÑOL



INDICE ESPAÑOL

| | Página | | Página |
|--|---------------|---|-------------|
| A | | | |
| ADAIR Pinza para cuello uterino | 23 - 17 | BAGGISH Pinzas sacabocado para biopsia uterinales | 23 - 34 |
| ADLERKREUTZ Pinzas vasculares y para tumores | 05 - 9 | BAINBRIDGE Pinza hemostatica | 09 - 12 |
| ADSON Elevador | 27 - 5 | BAKES Dilatadore para conducto dilia | 19 - 5 |
| ADSON | | BALFOUR Separador abdominal | 15 - 17 |
| Pinzas de diseccion | 05 - 3; 20 | BALFOUR Valva | 15 - 18 |
| Pinzas hemostaticas | 09 - 11 | BALFOUR-BABY Separador abdominal | 15 - 18 |
| Pinzas quirurgicas | 05 - 8; 9; 20 | BARRAQUER Micro porta aguja | 11 - 7 |
| Porta agujas | 11 - 2 | BARRAQUER-TROUTMAN Porta aguja | 11 - 7 |
| Separadores autoestaticos | 15 - 2 | BARRETT Pinzas uterinas | 23 - 17 |
| Tubo aspiracion | 17 - 9 | BARRY-STERNAL Hilo pinza | 11 - 16 |
| ADSON-BABY Pinzas hemostaticas | 09 - 15 | Bastidor para la fi jación | 15 - 24 |
| ADSON-BABY Separadores autoestaticos | 15 - 2 | BEACHAM Amniotomo | 23 - 22 |
| ADSON-BROWN Pinza quirurgicas | 05 - 9 | BECKMANN Separadores con retenida automática | 15 - 9 |
| ADSON-CONE Separadores autoestaticos | 15 - 7 | BECKMANN-ADSON Separadores con retenida automática | 15 - 8 |
| Adventitia tijera vascular, micro | 03 - 51 | BENGOLEA Pinza hemostatatica | 09 - 13 |
| Agrafes para suturas | 11 - 32 | BERGMANN Martillo | 27 - 11 |
| Aguja para anestesia | 17 - 12 | BERGMANN Tijeras para vendajes | 03 - 29 |
| Aguja para puncion lumbar | 17 - 14; 15 | BERLIN Pinza cierratubo | 07 - 6 |
| Aguja para biopsia | 17 - 15 | BERNHARD Pinza para campos | 07 - 2 |
| Agujas especiales | 17 - 12 | BIER Agujas para punción lumbar | 17 - 14 |
| Agujas para la punción del esternón | 17 - 12 | BIRKETT Collar de preparación | 09 - 10 |
| Agujas para ligadura | 11 - 22-26 | Bisturi para fibroma | 23 - 25 |
| ALAN-PARKS Especulo rectal | 21 - 13 | Bisturi mango | 01 - 6; 7 |
| ALAN-PARKS Valva | 21 - 13 | Bisturi para cono | 23 - 25 |
| ALEXANDER Escoplos | 27 - 9 | Bisturies desechables | 01 - 3 |
| ALEXANDER Pinza para biopsia | 23 - 33 | BLAKE Curetas uterinas | 23 - 32 |
| ALLIS | | BLAKE Pinza calculos biliares | 19 - 2 |
| Atraumatic pinza intestinales | 21 - 1 | BOETTCHEER Tijeras para amigdalas | 03 - 21 |
| Pinza intestinales y para agarrar tejido | 21 - 3 | BONNEY Pinza quirurgica | 05 - 13; 20 |
| Pinza intestinales | 21 - 1 | BOYS-ALLIS Pinza para intestinalesy para agarrar tejido | 21 - 3 |
| ALLIS-ADAIR Pinza intestinales | 21 - 2 | BOZEMANN | |
| ALLIS-BABY Pinza intestinales | 21 - 1 | Pinza para polipos | 07 - 3; 4 |
| ALLISON Espatulas pulmonares | 13 - 27 | Porta aguja | 11 - 16 |
| ALLPORT Separadores autorretentivo | 15 - 1 | Tijeras ginecologicas | 03 - 25 |
| ALM Separadores autorretentivo | 15 - 1; 2 | Torneros curran | 11 - 31 |
| Amniotomos | 23 - 22 | BRAITHWAITE Dermátomo | 01 - 11 |
| ANDERSON-ADSON Separador autorretentivopara laminectomia | 15 - 2 | BRAITHWAITE Dermátomo hoja de repuesto | 01 - 11 |
| ANDREWS-PINCHON Tubo de aspiracion | 17 - 9 | BRAUN | |
| Anoscopios | 21 - 14; 15 | Depresor uterino | 23 - 22 |
| AUVARD Especulo vaginales | 23 - 4 | Especulo vaginales | 23 - 12 |
| AYRE Bisturi para cono | 23 - 25 | Pinza para cuello uterino | 23 - 18 |
| B | | BRAUN-STADLER Tijeras para episiotomia | 03 - 28 |
| BABCOCK Pinza intestinales atraumata | 21 - 4 | BREISKY Especulo vaginales | 23 - 8 |
| BABCOCK Pinza para agarrar ogganos y tejidotejidos | 21 - 4 | BRODIE Sonda acanalada | 17 - 1 |
| BACKHAUS Pinza de campos | 07 - 1 | BROPHY Pinza de diseccion | 05 - 5 |
| BADGLEY Separadores costales | 15 - 27 | BROPHY Pinza quirurgica | 05 - 11 |
| | | BROPHY-SULLIVAN Tijeras fino nas para cirugia | 03 - 17 |
| | | BROWN Porta agujas | 11 - 2 |

| | | | |
|--|-----------------|--|--|
| BRUNNER | | | |
| Aguja para ligadura | 11 - 25 | | |
| Pinza intestinales | 21 - 8 | | |
| Separador | 13 - 24 | | |
| Sonda conductora | 11 - 28 | | |
| BRUNNER-FERROZELL | 11 - 30 | | |
| Sonda conductora | | | |
| BRUNS Cucharillas cortante | 27 - 1 | | |
| BRUNS Tijeras para vendaje | 03 - 30 | | |
| BRYANT Pinza de grano y para torundas | 07 - 3 | | |
| BUCK Tijeras para ligadura | 03 - 19 | | |
| BUELAU Trocar | 17 - 6 | | |
| Bujia dilatadora | 19 - 9 | | |
| Bujias uretrales | 19 - 9; 10 | | |
| Bulldog clamps, hemostatica | 09 - 2 | | |
| Bulldog clamps, vena | 09 - 2 | | |
| BUMM Cureta uterina | 23 - 30; 31 | | |
| BUNT Clip para esterilizar | 29 - 1 | | |
| BURKE Pinza para biopsia | 23 - 34 | | |
| BUSCH Tijeras para cordon umbilical | 03 - 28 | | |
| BYRD Tubo aspiracion | 17 - 10 | | |
| C | | | |
| Caja metalica | 23 - 15; 16 | | |
| Cajas para instrumentos | 29 - 3 | | |
| CAMPBELL Bujias uretrales | 19 - 10 | | |
| CAMPBELL Trocar toracica | 17 - 7 | | |
| CANNY-RYAL Separador | 13 - 12 | | |
| Canula para biopsia | 17 - 13 | | |
| CAPLAN Tijeras para tabique nasal | 03 - 20 | | |
| Capsulas de petri | 29 - 3 | | |
| CARMALT Pinza para espigas | 05 - 15 | | |
| CARREL Pinza hemostatica | 09 - 5 | | |
| CARTILAGE Cuchillo para reseccion | 01 - 10 | | |
| CASTROVIEJO Porta aguja | 11 - 21 | | |
| CASTROVIEJO Porta aguja, micro | 11 - 8 | | |
| Cateter metal | 19 - 9 | | |
| CATLIN Cuchillo para amputacion | 01 - 8 | | |
| Cazador hilo | 11 - 31 | | |
| Chaîne avec poids | 15 - 24 | | |
| CHAPUT Pinza hemostatica | 09 - 3 | | |
| CHEATLE Pinza para instrumentos | 29 - 1 | | |
| CHELSEA EATON Anoscopio | 21 - 15 | | |
| CHERON Pinza para polipos | 07 - 4 | | |
| CHILDE Pinza para borde de herida | 11 - 32 | | |
| Clamp bronquial | 09 - 22; 25 | | |
| Clamp cardiovasculares, atraumata | 09 - 3 | | |
| Clamp para conductora biliares | 09 - 14; 21; 22 | | |
| Clamps Bulldog | 09 - 1 | | |
| CLAUS Agujas ligaduras | 11 - 27 | | |
| CLAUS-EICKEN Agujas ligaduras | 11 - 27 | | |
| Clip para esterilizar | 29 - 1 | | |
| CLOWARD Modif. Separadores autorretentivo | 15 - 13 | | |
| CLOWARD Separadores autorretentivo | 15 - 12 | | |
| CLOWARD Valva | 15 - 12; 13 | | |
| COGSWELL Tubo de aspiracion | 17 - 9 | | |
| COHEN Histerometros | 23 - 14 | | |
| Collar de preparacion | 09 - 10 | | |
| COLLIER Porta aguja | 11 - 1 | | |
| COLLIN | | | |
| Martillo | 27 - 11 | | |
| Bisturi mango de metal | 01 - 6 | | |
| Cuchillo para amputacion | 01 - 8 | | |
| Especulo vaginales | 23 - 1 | | |
| Histerometro | 23 - 23 | | |
| Mango de bisturies | 01 - 2 | | |
| Pinza hemostatica oval | 09 - 3 | | |
| Pinza histerolabo | 23 - 22 | | |
| Pinza para grapas | 11 - 31 | | |
| Pinza para polipos | 07 - 4 | | |
| Separadores abdominal | 15 - 15 | | |
| COLLIN-BABY Separadores abdominales | 15 - 14 | | |
| COLLIN-DUVAL Pinzas quirurgicas | 5 - 12 | | |
| CONE Separador | 15 - 7 | | |
| Cono grande | 23 - 14 | | |
| COOLEY Tubo aspiracion | 17 - 10 | | |
| COOPER Aguja para ligaduras | 11 - 24 | | |
| COPPELSON Pinza para biopsia | 23 - 34 | | |
| CORYLLOS Separador | 13 - 23 | | |
| COTTLE Tijeras nasales | 03 - 20 | | |
| COUPLAND Tubo de aspiracion | 17 - 9 | | |
| CRAFOORD Pinza hemostatica | 09 - 11 | | |
| CRAFOORD-SELLORS Pinza bronquial | 09 - 22 | | |
| CRAFOORD-STELZNER Tijeras intestinalesales | 03 - 24 | | |
| CRILE Pinza hemostatica | 09 - 9 | | |
| CRILE-RANKIN Pinza hemostatica | 09 - 10 | | |
| CRILE-WOOD Porta aguja | 11 - 2 | | |
| Cuadro abdominal | 15 - 20; 21; 23 | | |
| Cubetas | 29 - 2; 3 | | |
| Cubierto | 11 - 32 | | |
| Cucharilla para los calculos biliares | 19 - 3; 4 | | |
| Cucharillas cortantes | 27 - 1; 2; 3 | | |
| Cucharillas para aborto | 23 - 37; 38 | | |
| Cuchillo para cerebro mango hueco | 01 - 9 | | |
| Cuchillo para amputacion | 01 - 8; 10 | | |
| Cuchillo para órganos hoja | 01 - 9 | | |
| Cuchillo para reseccion | 01 - 10 | | |
| Cureta aspiradoras | 23 - 24 | | |
| Cureta para biopsia | 23 - 24 | | |
| Cureta uterinas | 23 - 24; 26-32 | | |
| Curetetas para lupus | 25 - 1; 2 | | |
| CUSCO Especulo vaginales | 23 - 2 | | |
| CUSHING | | | |
| Ganchos en forma de selle | 13 - 8 | | |
| Pinza estriada | 05 - 4 | | |
| Pinza quirurgica | 05 - 11 | | |
| Separador para nervios | 13 - 4 | | |

INDICE ESPAÑOL

| | | | |
|--|-------------|---|-------------|
| CUSHING-TAYLOR Pinza diseccion | 05 - 20 | DOYEN | |
| CZERNY | | Periostot | 27 - 6 |
| Pinza calculos biliares | 19 - 2 | Especulo vaginales | 23 - 7; 12 |
| Pinza para cuello uterino | 23 - 20 | Estilete acanalado | 17 - 1 |
| Separador | 13 - 12 | Periostotomos para costilla | 27 - 6 |
| D | | Pinza intestinales | 21 - 5 |
| DANDY Pinza hemostática | 09 - 9 | Pinza intestinalesal atraumata | 21 - 6 |
| DANDY Tijeras neuroquirurgicas | 03 - 18 | Pinzas para polipos uterinos | 23 - 21 |
| DARTIGUES Pinza hysterolabo | 23 - 21 | Separador abdomimal | 13 - 19 |
| DAUBENSPECK Cucharilla cortante | 27 - 2 | Tijeras ginecologicas | 03 - 25 |
| DAVIDSON Separador (scapula) | 13 - 27 | Tirabuzon para fibroma | 23 - 25 |
| DAVIDSON Trocar | 17 - 6 | DOYEN-BADY Pinza intestinalesal | 21 - 5 |
| DE BAKEY | | DOYEN-STILLE Separador | 13 - 20 |
| Clamp Bulldog atraumata | 09 - 2 | DUBOIS Tijeras ginecologicas | 03 - 26 |
| Pinza araumata | 05 - 18 | DUEHRSEN Pinza de diseccion | 05 - 5 |
| Porta agujas | 11 - 13 | DUEHRSEN Pinza quirurgica | 05 - 12 |
| Separadores con retenida automática | 15 - 9 | DUPLAY Pinza para cuello uterino | 23 - 18 |
| Tijeras vasculares | 03 - 23; 38 | DURANTE Pinza quirurgica | 05 - 12 |
| Tubo de aspiracion | 17 - 9 | DUVAL Pinza para tejido | 21 - 4; 5 |
| DE LA ROZA Aguja de ligaduras | 11 - 26 | DUVAL Pinza intestinales | 05 - 12 |
| DE LEE Forceps obstetricos | 23 - 35 | E | |
| DE MARTEL-WOLFSON Pinza para cerrar clamps | 21 - 9 | EISELSBERG Tijera para ligaduras | 03 - 18 |
| DE MARTEL-WOLFSON Pinza para anastomosis | 21 - 9 | El tamiz | 23 - 15; 16 |
| DEAVER Separador | 13 - 26; 27 | Elevador | 27 - 4; 5 |
| DEAVER Tijeras para quirurgical | 03 - 2; 3 | ELLIOT Forceps obstetricos | 23 - 36 |
| DENNIS-BROWN Separador abdominal | 15 - 20 | EMMET Gancho para fistulas | 23 - 25 |
| Depresor uterino | 23 - 22 | Endarterectomy tijeras de diseccion | 03 - 42 |
| DERF Porta aguja | 11 - 1; 10 | ENGL. MOD. Pinza de diseccion | 05 - 4 |
| Dermátomo barra oscilante | 01 - 11 | EPPENDORFER Pinza para biopsia | 23 - 33 |
| DESCHAMPS Aguja aguda derecha | 11 - 23 | Escoplos | 27 - 7-10 |
| DESJARDINS | | ESMARCH Tijeras para vendajes | 03 - 30 |
| Clamp para conductor biliares | 09 - 21 | Espatula vesical | 19 - 8 |
| Cucharilla para los calculos biliares | 19 - 4 | Espatulas pulmonares | 13 - 27 |
| Exploradore para calculos biliares | 19 - 4 | Especulo endocervicales | 23 - 13 |
| Pinza calculos biliares | 19 - 1 | Especulo rectal | 21 - 12 |
| DESMARRES Ganchos en forma de selle | 13 - 7 | Especulo vaginales | 23 - 1-12 |
| DESMARRES Separador (parpados) | 13 - 7 | Estilete abotonado | 17 - 1 |
| DIEFFENBACH Bisturi mango de metal | 01 - 7 | Estilete hoja mirte | 17 - 1 |
| DIEFFENBACH Serra-fina | 9 - 1 | Estuche de instrumentos | 11 - 32 |
| DIETHRICH Porta agujas, micro | 11 - 10 | Exploradore para cálculos diliares | 19 - 4 |
| DIETHRICH Tijeras vasculares | 03 - 22; 38 | F | |
| DIETHRICH-HEGEMANN Tijeras vasculares | 03 - 39 | FALK Aguja para ligadure | 11 - 27 |
| Dilatador para el cuello vesical | 19 - 7 | FARABEUFG Periostotomo | 27 - 5 |
| Dilatador uterino | 23 - 15-17 | FARABEUFG Separador | 13 - 10 |
| Dilatador, vascular | 5 - 17 | FARREL Porta-algodon | 17 - 3 |
| Dilatadore para el conductora bilia | 19 - 5 | FAURE Pinza de peritoneo | 09 - 26 |
| DISSECTING Bisturi mango de metal | 01 - 7 | FAURE Pinza para biopsia | 23 - 32 |
| DITTEL Bujias uretrales | 19 - 9 | FAVOLORO Tijeras vasculares | 03 - 23 |
| DOUGLAS Trocar y canula | 17 - 8 | FEILCHENFELD Pinza para espigas | 05 - 15 |
| | | FEIN Porta alogdón | 17 - 3 |
| | | FERGUSSON Tijeras para cirugia | 03 - 17 |
| | | FERGUSSON Cucharilla para los cálculos diliares | 19 - 3 |
| | | FERGUSSON Pinza clamp de presion | 09 - 5 |

| | |
|--------------------------------------|-------------|
| FERGUSSON Tubo de aspiracion | 17 - 11 |
| FERRIS-SMITH Pinza quirurgica | 05 - 5 |
| FINOCHIETTO | |
| Separadores costales | 15 - 26 |
| Clamp bronquial | 09 - 22 |
| Porta aguja | 11 - 4; 15 |
| Tijeras para lobectomía | 03 - 27 |
| FINSEN Separador augdo | 15 - 1 |
| FOERSTER Pinza para esponges estrech | 07 - 5 |
| FOMON Tijera de disección | 03 - 6 |
| FOMON Tijeras nasales | 03 - 19 |
| Forceps obstetricos | 23 - 35; 36 |
| FOX Curetas para lupus | 25 - 2 |
| FRANZ | |
| Cuadro | 15 - 23 |
| Separadores abdominales | 15 - 23 |
| Valva | 15 - 23 |
| FRAZIER Ganchito (duramad) agudo | 13 - 1 |
| FRAZIER Tubo de aspiracion | 17 - 11 |
| FRITSCH Separador | 13 - 19 |

G

| | |
|---|------------|
| Ganchito (duramad) | 13 - 1 |
| Ganchito, IRIS | 13 - 1 |
| Ganchito delicato | 13 - 1 |
| Ganchito doble pequeno | 13 - 2 |
| Ganchito fino | 13 - 2 |
| Ganchito para la piel | 13 - 1 |
| Ganchito para mucosa | 13 - 1; 2 |
| Gancho para fistulas | 23 - 25 |
| Ganchos en forma de selle | 13 - 7-9 |
| GARLAND Pinza para histerectomia | 09 - 28 |
| GELPI Separador perineal | 15 - 7 |
| GEMINI Pinza diseccion ligadura | 09 - 19 |
| GERALD Pinza estriada | 05 - 4 |
| GERALD Pinza quirurgica | 05 - 10 |
| GILLIES | |
| Pinza quirurgica | 05 - 9; 20 |
| Ganchito delicato | 13 - 1 |
| Porta aguja/tijeras | 11 - 17 |
| GIL-VERNET Ganchos en forma de selle | 13 - 9 |
| GLASSMAN Pinza intestinalesal | 21 - 8 |
| GLOVER Clamp cardiovasculares atraumata | 09 - 3 |
| GOELET Separador | 13 - 12 |
| GOMEL Micro porta aguja | 11 - 7 |
| GOOD Tijeras para amigdalas | 03 - 21 |
| GOSSET Separador abdominal | 15 - 16 |
| GRAEFE Ganchito, IRIS | 13 - 1 |
| GRAEFE Pinza quirurgica | 05 - 7; 16 |
| GRAVE Especulo vaginales | 23 - 3 |
| GRAY Clamp para conductor biliares | 09 - 22 |
| GRAZIL Tijeras quirurgicas | 03 - 4 |
| GREEN-ARMYTAGE Pinza clamp uterinas | 23 - 37 |
| GROSS-MAIER Pinza de curacion y para torundas | 07 - 5 |
| Gubia | 27 - 7-10 |

| | |
|--|-----------------|
| GUTHRIE Ganchito doble grande | 13 - 2 |
| GUYON | |
| Atraumata pinza amigdalas, pinza para pediculo renal | 09 - 23 |
| Bujias uretrales | 19 - 10 |
| Pinza para pediculo renal | 09 - 23 |
| H | |
| HABERER Separadores abdominal | 15 - 25 |
| HAIGHT Separadores costales | 15 - 27 |
| HALLE Cucharilla cortante | 27 - 2 |
| HALLE Tijeras nasales | 03 - 19 |
| HALSEY Porta aguja | 11 - 11 |
| HALSTED-MOSQUITO Pinza hemostática | 09 - 7 |
| HANK Dilatador uterino | 23 - 16 |
| HARRINGTON Separador | 13 - 23 |
| HARTMANN Pinza hemostatica | 09 - 6 |
| HAYES Pinza para anastomoses | 21 - 11 |
| HEANEY Pinza para histerectomia | 09 - 29 |
| HEANEY Porta agujas | 11 - 4 |
| HEANEY-BALLANTINE Pinza para histerectomia | 09 - 28 |
| HEANEY-KANTER Pinza para histerectomia | 09 - 28 |
| HEGAR Dilatador uterino | 23 - 15; 16 |
| HEGAR Porta aguja | 11 - 16 |
| HEGAR-BAUMGARTNER Porta aguja | 11 - 1 |
| HEGEMANN Tijeras vasculares | 03 - 44 |
| HEGEMANN-DIETRICH Tijeras vasculares | 03 - 22 |
| HEGENBARTH Pinza para grapas | 11 - 31 |
| HEISS Pinza hemostaticas ligadure | 09 - 14 |
| HENLY Separador | 15 - 11 |
| HENLY Valve | 15 - 11 |
| HEPP-SCHIEDL | |
| Tubo aspiracion | 17 - 10 |
| Porta aguja | 11 - 20 |
| Tijera, micro | 03 - 45 |
| HERRICK Pinza para pediculo renal | 09 - 24 |
| HESS Clamps Bulldog | 09 - 1 |
| HESSBERG Aguja para ligadure | 11 - 26 |
| HEYMANN Tijeras nasales | 03 - 20 |
| HEYMANN Tijeras para amigdalas | 03 - 20 |
| HEYWOOD-SMITH Pinza para hemorroides | 23 - 21 |
| HIRSCHMANN Anoscopio | 21 - 14 |
| Histerometro | 23 - 14; 22; 23 |
| Hoja de bisturi esteril | 01 - 5 |
| Hoja de repuesto | 01 - 11 |
| Hoja de repuesto para sierra | 25 - 3 |
| HOSEMANN Pinza hemostatica | 09 - 21 |
| HUMBY Dermátomo | 01 - 11 |
| HUNTER Pinza para espigas | 05 - 15 |
| HURD Palo á cio aguja | 11 - 27 |
| HURWITZ Trocar | 17 - 5 |
| HYSTEREKTOMY Tijeras para disección | 03 - 36 |

INDICE ESPAÑOL

I

| | |
|------------------------------------|-------------|
| Instrument pinza de larg | 29 - 1 |
| Instrumentos circuncion | 19 - 10 |
| IOWA Aguja para anestesia pudendus | 17 - 12 |
| IOWA Pinza uterina | 23 - 20 |
| IRIS Tijeras fino nas para cirugia | 03 - 15; 16 |
| ISRAEL Separador | 13 - 14 |
| IVES FANSLER Anoscopio | 21 - 15 |

J

| | |
|--------------------------------------|---------|
| JABALEY Tijeras quirurgicas | 03 - 42 |
| JACKSON Especulo vaginales | 23 - 9 |
| JACOBI Aguja ligadure | 11 - 26 |
| JACOBS Pinza uterina | 23 - 19 |
| JAMISON Porta agujas | 11 - 4 |
| JAMISON Tijeras de diseccion | 03 - 42 |
| JANSEN Cucharilla cortantes | 27 - 3 |
| JANSEN Separador | 15 - 1 |
| JARCHO Pinza para cuello uterino | 23 - 18 |
| JOBSON-HORNE Porta-algodon | 17 - 3 |
| JOHNS-HOPKINS Pinza hemostatica | 09 - 15 |
| JOHNS-HOPKINS Serra-fina | 09 - 1 |
| JOLL-FRIEDMAN Separador vaginales | 15 - 10 |
| JONES Pinza para campos | 07 - 1 |
| JOSEPH Ganchito para mucosa | 13 - 1 |
| JOSEPH Tijeras para cirugia plástica | 3 - 13 |
| JUDD-ALLIS Pinza intestinales | 21 - 2 |
| JUDD-MASSON Separador para la vejiga | 19 - 6 |

K

| | |
|--------------------------------------|---------|
| KAHN Pinza para cuello uterino | 23 - 18 |
| KALLMORGEN Especulo vaginales | 23 - 9 |
| KALT Micro porta agujas | 11 - 10 |
| KANTROWITZ Pinza diseccion ligadura | 09 - 19 |
| KAYE Tijeras para Face-lift | 03 - 41 |
| KELLY | |
| Pinza diseccion ligadura | 09 - 18 |
| Pinza hemostatica | 09 - 8 |
| Pinzas para polipos uterinos | 23 - 21 |
| Proctoscopio | 21 - 14 |
| Separador | 13 - 18 |
| Tijeras para fistulas | 03 - 26 |
| KELLY-RANKIN Pinza hemostatica | 09 - 8 |
| KEVORKIAN Cureta para biopsia | 23 - 24 |
| KEVORKIAN Pinza para biopsia | 23 - 34 |
| KEVORKIAN-YOUNGE Pinzas para biopsia | 23 - 33 |
| KEYES Trepano | 25 - 1 |
| KIELLAND Forceps obstetricos | 23 - 36 |
| KIELLAND-LUIKART Forceps obstetricos | 23 - 36 |
| KILNER | |
| Tijeras de diseccion fino | 03 - 44 |
| Ganchito para la piel | 13 - 1 |
| Porta aguja | 11 - 11 |
| Tijeras para cirugia plástica | 03 - 12 |

| | |
|---|-------------|
| KIRSCHNER Separadores abdominales | 15 - 21; 22 |
| KIRSCHNER Sonda conductora | 11 - 30 |
| KLEINERT-KUTZ Separadores | 13 - 1 |
| KLIMA-ROSSEGGER Agujas para la punción del esternón | 17 - 12 |
| KLINKENBERGH LOTH Tijeras vasculares toracica | 03 - 24 |
| KNAPP Separadores | 13 - 3 |
| KNOWLES Tijeras para vendaje dedo | 03 - 30 |
| KOCHER | |
| Aguja ligadure | 11 - 25 |
| Espatula vesical | 19 - 8 |
| Pinza hemostatica fina | 9 - 12 |
| Pinza intestinales | 21 - 6 |
| Pinza intestinales atraumata | 21 - 7 |
| Separadores | 13 - 20 |
| Sonda para bocio | 11 - 30 |
| KOCHER-LANGENB Separadores | 13 - 16 |
| KOENIG Sonda conductora | 11 - 29 |
| KOERTE Separador | 13 - 14 |
| KOGAN Especulo endocervicales | 23 - 13 |
| KÖNIG Periostotomo | 27 - 5 |
| KRAUSE Trocar y canula | 17 - 8 |
| KRISTELLER Especulo vaginales | 23 - 5; 6 |
| KRISTELLER Valva | 23 - 5 |
| KROENLEIN Pinza hemostática recta | 09 - 5 |
| KRONECKER Aguja ligadure | 11 - 26 |

L

| | |
|--|-----------|
| LAHEY Pinza para conducto biliar | 09 - 21 |
| LAHEY Separador | 13 - 20 |
| LAMBOTTE | |
| Mini osteotomo | 27 - 11 |
| Osteotomo | 27 - 11 |
| Periostotomo | 27 - 5 |
| LANDAU Especulo vaginales | 23 - 11 |
| LANDAU Trocar | 17 - 6 |
| LANDOLT Tijeras fino | 03 - 14 |
| LANE | |
| Pinza Clamp estomacal | 21 - 10 |
| Pinza intestinales y para agarrar tejido | 21 - 2 |
| Pinza para campos | 07 - 2 |
| Pinza quirurgica | 05 - 14 |
| LANGENBECK | |
| Cuchillo para reseccion | 01 - 10 |
| Elevador | 27 - 4; 9 |
| Porta aguja | 11 - 20 |
| Separador | 13 - 15 |
| Separador, mini | 13 - 5 |
| LANGENBECK-GREEN Separador | 13 - 4 |
| LAWRENCE Pinza de diseccion y para ligaduras | 09 - 21 |
| LAWRENCE Porta aguja | 11 - 3 |
| LEGUEU Espatula vesical | 19 - 8 |
| LEGUEU Separador para la vejiga | 19 - 6 |

| | |
|---|-------------|
| LEMPERT Cucharilla cortantes | 27 - 2 |
| LERICHE Pinza hemostatica | 09 - 9 |
| LERMOYEZ Trocar toracica | 17 - 7 |
| LEXER Tijera de diseccion | 03 - 11; 32 |
| LEXER-BABY Tijeras de diseccion | 03 - 11 |
| LICHTENBERG Porta aguja | 11 - 6; 19 |
| LICHTWITZ Trocar seno maxilar | 17 - 8 |
| LINCOLN Tijeras vasculares | 03 - 20 |
| LISTER Pinza para polipos (sinus) | 07 - 3 |
| LISTER Tijeras para vendajes | 03 - 29 |
| LISTER-EXCENTRIC Tijeras para vendajes | 03 - 29 |
| LISTON Cuchillo para amputacion | 01 - 8 |
| LITTAUER Tijeras para ligadura | 03 - 19 |
| LITTLE Separador | 13 - 21 |
| LITTLE-WOOD Pinza intestinales y para agarrar tejido | 21 - 2 |
| LLOYD-DAVIES Tijeras para enterotomia | 03 - 26 |
| LOCKHART-MUMMERY Sonda | 17 - 2 |
| LOCKWOOD Pinza intestinales y para agarrar tejido | 21 - 3 |
| LOCKWOOD-ALLIS Pinza intestinales y para agarrar tejido | 21 - 2 |
| LONG Pinza para histerectomia | 09 - 28 |
| LORENZ Tijeras para vendajes | 03 - 30 |
| LORNA Pinza para campos | 07 - 2 |
| LOVELACE Pinza hemostática estriada | 09 - 10 |
| LOVELACE Pinza pulmonar | 09 - 24 |
| LOWER Pinza para conductora biliar | 09 - 21 |
| LUER-KOERTE Cucharilla para coger cálculos diliares | 19 - 3 |
| LUER-LOCK Agujas especiales | 17 - 12 |
| M | |
| M.G.H. Porta aguja | 11 - 2 |
| MAGILL Mandrin | 17 - 10 |
| MAGILL Tubo aspiracion | 17 - 10 |
| MAINGOT Pinza para histerectomia | 09 - 27 |
| Mango de bisturies | 01 - 1; 2 |
| Mango suelto | 17 - 4 |
| MARTEL Pinza para el pericraneos | 09 - 4 |
| Martillo | 27 - 11 |
| MARTIN | |
| Histerometro | 23 - 23 |
| Pelvimetro | 23 - 38 |
| Cucharilla cortantes | 27 - 3 |
| MASSON Porta agujas | 11 - 15 |
| MATHIEU | |
| Especulo rectal | 21 - 12 |
| Especulo vaginales | 23 - 11 |
| Pinza para cuerpara | 19 - 7 |
| Porta aguja | 11 - 6; 19 |
| Porta aguja, fino | 11 - 18 |
| Separador | 13 - 11 |
| MATHIEU-KOCHER Porta aguja | 11 - 7 |
| MATZENAUER Especulo vaginales | 23 - 12 |

| | |
|---|------------------------|
| MAYO | |
| Clip para esterilizar | 29 - 1 |
| Cucharilla para los cálculos diliares | 19 - 3 |
| Sonda para conducto biliar | 19 - 4 |
| Tijeras de diseccion | 03 - 5 |
| Tijeras quirurgicas | 03 - 41 |
| Tijeras uterinas | 03 - 5; 32 |
| MAYO-ADAMS Separador autorretentivo | 15 - 4 |
| MAYO-BLAKE Pinza calculos biliares | 19 - 1 |
| MAYO-HEGAR Porta aguja | 11 - 3; 12 |
| MAYO-NOBLE Tijeras de diseccion | 03 - 6 |
| MAYO-ROBSON Pinza intestinales | 21 - 7 |
| MAYO-ROBSON Pinza intestinales, atraumata | 21 - 7 |
| MAYO-STILLE Tijeras de diseccion | 03 - 6; 32 |
| MC DONALD Elevador doble | 27 - 4 |
| MC GIVNEY Ligator para hemorroides | 21 - 16 |
| MC INDOE | |
| Pinza de diseccion | 05 - 3 |
| Pinza diseccion | 05 - 20 |
| Pinza quirurgica | 05 - 10 |
| Tijeras para cartilago | 03 - 24 |
| MC LEAN Forceps obstetricos | 23 - 36 |
| MC QUIGG-MIXTER Pinza diseccion/ligadura | 09 - 22 |
| MEEKER Pinza hemostatica | 09 - 20 |
| MENGHINI Aguja para biopsie | 17 - 15 |
| MENGHINI Trocar para agujas puncion | 17 - 15 |
| METZENBAUM Porta agujas | 11 - 2 |
| METZENBAUM Tijeras de diseccion | 03 - 8; 10; 33; 36; 41 |
| METZENBAUM-BABY Tijeras de diseccion | 03 - 7; 9; 43 |
| METZENBAUM-FINO Tijeras | 03 - 9; 34; 35 |
| METZENBAUM-LAHEY Tijeras de diseccion | 03 - 35 |
| METZENBAUM-NELSON Tijeras de diseccion | 03 - 8; 41 |
| MEYERDING Separadores | 13 - 5 |
| MICHEL Agrafes parasuturas | 11 - 32 |
| MICHEL Equipo de sutura | 11 - 32 |
| MICHEL Pinza aplicadoras de agrafes | 11 - 31; 32 |
| Micro-ADSON Micro pinza de diseccion | 05 - 3; 8 |
| Micro-ADSON Pinzas de diseccion y ligadura | 09 - 15 |
| Micro-MOSQUITO Pinza hemostatica | 09 - 8 |
| MIDDELDORPF Separador | 13 - 18 |
| MIKULICZ | |
| Pinza de peritoneo | 09 - 25 |
| Pinza para anastomosis | 21 - 11 |
| Separador | 13 - 22 |
| MIKULICZ-BABY Pinza de peritoneo | 09 - 25 |
| MILAN Cureta para biopsia | 23 - 24 |
| MILLIGAN Separador | 15 - 6 |
| MILLIN | |
| Dilatador para el cuello vesical | 19 - 7 |
| Pinza apsular atraumatic | 19 - 7 |
| Pinza capsular para prostatectomia retropública | 19 - 7 |

INDICE ESPAÑOL

| | | | |
|--|-------------|-----------------|--|
| MILLIN | | | |
| Pinza para coger los lóbulos anteriores | 19 - 7 | | |
| Pinza porta-ligaduras supra-pubian | 19 - 7 | | |
| Separador para la vejiga | 19 - 6 | | |
| Mini-GEMINI Pinza de diseccion ligadura | 09 - 19 | | |
| Mini-TOWNSEND Pinzas para biopsia | 23 - 34 | | |
| MIXTER | | | |
| Pinza calculos biliares | 19 - 1 | | |
| Pinza hemostatic y bronquial | 09 - 20; 21 | | |
| Tijera de diseccion | 03 - 11 | | |
| MIXTER-BABY Pinza hemostatica | 09 - 6; 15 | | |
| MIXTER-BABY Pinza para hilo | 09 - 6 | | |
| MIXTER-O'SHAUGNESSY Pinza hemostatic | 09 - 20 | | |
| MOCK Agujas especiales | 17 - 12 | | |
| MOD. BONN Tijeras fino nas para cirugia | 03 - 16 | | |
| MOD. USA Tijeras de diseccion | 03 - 28 | | |
| MOD. WIEN Hilo cazador | 11 - 31 | | |
| MOLLISON Separador | 15 - 3 | | |
| MOORE Cucharilla para los cálculos diliares | 19 - 4 | | |
| MORGAN Proctoscopio | 21 - 15 | | |
| MORRIS Separador | 13 - 22 | | |
| MOYNIHAN Pinza Clamp boca cort | 09 - 27 | | |
| MOYNIHAN Sonda calculos biliares | 19 - 3 | | |
| MUSEUX Pinza para cuello uterino | 23 - 20 | | |
| N | | | |
| NABATOFF | | | |
| Cable de traccion | 17 - 4 | | |
| Mango suelto | 17 - 4 | | |
| Oliva | 17 - 4 | | |
| Punta de sonda seulta | 17 - 4 | | |
| Sonda para varices | 17 - 4 | | |
| NAEGELE Forceps obstetricos | 23 - 36 | | |
| NAGER Aguja ligadura | 11 - 27 | | |
| NEGUS Pinza amigdalas | 09 - 14 | | |
| NEIVERT Porta aguja | 11 - 1 | | |
| NELATON Sonda acanalada | 17 - 1 | | |
| NELSON Pinzas quirurgicas | 05 - 12 | | |
| NELSON Trocar toracica | 17 - 7 | | |
| NORFOLK-NORWICH Separador autorretentivo para laminectomia | 15 - 10 | | |
| NORTHBENT-SPENCER Tijera para ligaduras | 03 - 18 | | |
| NOTO Pinzas para polipos uterinos | 23 - 21 | | |
| NOVAK Cureta aspiradoras | 23 - 24 | | |
| O | | | |
| OCHSNER Sonda calculos biliares | 19 - 4 | | |
| OCHSNER Trocar toracica | 17 - 7 | | |
| OCHSNER-KOCHER Pinza hemostatica | 09 - 13 | | |
| O'CONNOR Ganchito mucosa | 13 - 1 | | |
| Oliva | 17 - 4; 9 | | |
| OLSEN-HEGAR Porta aguja | 11 - 17 | | |
| Osteotomo | | 27 - 7; 8; 11 | |
| Osteotomo, mini | | 27 - 11 | |
| O'SULLIVAN-O'CONNOR | | | |
| Cuadro | | 15 - 20 | |
| Separadores abdominales | | 15 - 20 | |
| Valva | | 15 - 20 | |
| OVERHOLT Pinza forma | | 09 - 16 | |
| OVERHOLT-BABY Pinza hemostática | | 09 - 9 | |
| OVERHOLT-GEISSENDOERFER Pinza de diseccion, ligadura | | 09 - 17 | |
| OVERHOLT-MIXTER Pinza hemostatica | | 09 - 15 | |
| P | | | |
| Paparell tijeras | | 03 - 16 | |
| PARKER Separador | | 13 - 11 | |
| PARKER-LANGENBECK Separador | | 13 - 12 | |
| PARTSCH | | | |
| Escoplos | | 27 - 7 | |
| Gubia | | 27 - 8 | |
| Martillo | | 27 - 11 | |
| PAYR Sonda conductora | | 11 - 29 | |
| PAYR-BABY Pinza clamp intestinales | | 21 - 9 | |
| PEAN Pinza hemostatica, fina | | 09 - 12 | |
| PEAN Pinza hemostatica | | 09 - 6 | |
| PEDERSON Especulo vaginales | | 23 - 3 | |
| PEERS Pinza para campos | | 07 - 3 | |
| PELKMANN Pinza para polipos | | 07 - 4 | |
| Pelvimetro | | 23 - 38 | |
| PENNINGTON Pinza hemostatica | | 09 - 4 | |
| Perforador de útero | | 23 - 25 | |
| Perforador para unas | | 25 - 1 | |
| Periostotomo | | 27 - 5; 6 | |
| Periostotomo costal | | 27 - 6 | |
| PESTALOZZA Cucharillas para aborto | | 23 - 37 | |
| PHANEUF Pinza para el peritoneo | | 09 - 26 | |
| PIERCE Trocar seno maxilar | | 17 - 7 | |
| PIFFARD Curetas para lupus | | 25 - 1 | |
| Pinza | | | |
| agrafes para suturas | | 11 - 32 | |
| amigdalas | | 09 - 23 | |
| aplicadoras de agrafes | | 11 - 32 | |
| biopsie rectal | | 21 - 16 | |
| bronquial | | 09 - 14; 24; 25 | |
| calcular atraumatic | | 19 - 7 | |
| calcular para prostatectomia retropública | | 19 - 7 | |
| calculos biliares | | 19 - 1; 2 | |
| calculos renal | | 19 - 1 | |
| cierratubo bocas estriad | | 07 - 6 | |
| cierratubo bocas lisas | | 07 - 6 | |
| cierratubo con protector | | 07 - 6 | |
| clamp boca cort | | 09 - 27 | |
| clamp de presion | | 09 - 5 | |
| clamp estomacal | | 21 - 10 | |
| clamp intestinales | | 21 - 9 | |

Pinza

| | |
|---|---------------------------|
| clamp uterinas | 23 - 37 |
| combinad para grapas | 11 - 31; 32 |
| de curacion y para torundas | 07 - 3; 4 |
| de diseccion | 05 - 1; 3-5; 7; 19; 20 |
| de peritoneo | 09 - 25 |
| de peritoneo ligadure | 09 - 26 |
| de relojero recta | 05 - 17 |
| diseccion y ligadura | 09 - 15-20, 22 |
| diseccion y para ligaduras | 09 - 20; 21 |
| diseccion, micro | 05 - 3; 20 |
| hemostatica | 09 - 3-15; 18; 20 21 |
| hemostatica atraumatic | 09 - 4 |
| hemostática estriada | 09 - 10 |
| hemostatica fina | 09 - 12 |
| histerolabo | 23 - 21; 22 |
| intestinal | 21 - 1; 2; 5-8; 10 |
| intestinales autramata | 21 - 1; 4; 6; 7 |
| intestinales y para agarrar tejido | 21 - 3 |
| inza para borde de herida | 11 - 32 |
| inza para campos | 07 - 1-3 |
| inza para cerrar | 21 - 9 |
| inza para coger el cuello del útero | 23 - 18 |
| inza para coger los lóbulos anteriores | 19 - 7 |
| micro | 05 - 15 |
| oracica | 09 - 16 |
| para aborto y placenta | 23 - 37; 38 |
| para amigdalas | 09 - 11 |
| para anastomose | 21 - 9; 11 |
| para aplicar clamp Bulldog | 09 - 1 |
| para arrancar unas | 25 - 3 |
| para biopsia | 23 - 32-34 |
| para conducto biliar | 09 - 21 |
| para cuello uterino | 23 - 17-20 |
| para cuerpara | 19 - 7 |
| para el penis | 19 - 10 |
| para el pericraneio | 09 - 4 |
| para el peritoneo | 09 - 26 |
| para espigas | 05 - 14; 15 |
| para esponjas | 07 - 5 |
| para esterilizar | 29 - 1 |
| para grapas | 11 - 31 |
| para hemorroides | 21 - 17; 23 - 21 |
| para hilo | 09 - 6; 11 - 16 |
| para histerectomia | 09 - 28; 29 |
| para histerectomia ligadura | 09 - 26; 27 |
| para instrumentos | 29 - 1 |
| para intestinos intestinales | 21 - 3 |
| para medicac | 07 - 3 |

Pinza

| | |
|--|---------------------------------------|
| para pediculo renal | 09 - 23; 24 |
| para polipos | 07 - 3-5 |
| para polipos uterinos | 23 - 21 |
| para tejidos intestinales | 05 - 12; 21 - 2-5 |
| para, IRIS | 05 - 7; 16 |
| porta-ligaduras supra-pubian | 19 - 7 |
| pulmonar | 09 - 24 |
| quirurgica | 05 - 6-13; 20 |
| quirurgica, micro | 05 - 8 |
| quirurgica, modelo ruso | 05 - 11 |
| quirurgica, modelo USA | 05 - 8 |
| sacabocado para biopsia uterinals | 23 - 34 |
| uro-tangential | 09 - 24 |
| USA diseccion | 05 - 2 |
| uterina | 23 - 17; 19; 20 |
| vasculares, atraumata | 05 - 18 |
| PIPER Forceps obstetricos | 23 - 36 |
| Placa para extender la piel | 01 - 10 |
| PLESTER Separador | 15 - 6 |
| POOLE Tubo de aspiracion | 17 - 8 |
| POPPE-FERGUSSON Tubo de aspiracion | 17 - 11 |
| Porta-aguja | 11 - 1-7; 10-14; 16; 17; 19-21; 26 |
| Porta-aguja, fino | 11 - 6; 18 |
| Porta-aguja, micro | 11 - 7-10 |
| Porta-aguja, vascular | 11 - |
| Porta-algodón | 17 - 3 |
| Porta-algodón, fino | 17 - 3 |
| Porta-clamps | 21 - 9 |
| POTTS-DE MARTEL | |
| Tijeras vasculares | 03 - 22; 23; 38; 39 |
| Pinza de diseccion | 05 - 4; 20 |
| Pinza quirurgica | 05 - 11 |
| Tijeras para anatomia | 03 - 27 |
| Tijeras de diseccion | 05 - 20 |
| POZZI Pinzas para coger el cuello del útero | 23 - 18 |
| PRATT | |
| Cysticus separador | 21 - 17 |
| Dilatador uterinos | 23 - 16 |
| Pinza hemostatica | 09 - 5 |
| Pinza uterina | 23 - 20 |
| PRESBYTERIAN Pinza cierratubo bocas lisas | 07 - 6 |
| PRICE-THOMAS Pinza bronquial | 09 - 24; 25 |
| PRINCE Tijeras para amigdalas | 03 - 21 |
| Proctoscopio | 21 - 14; 15 |
| Providence-Hospital Pinza hemostatica | 09 - 7 |
| Punta de sonda seulta | 17 - 4 |
| PYE-SMITH-HARRISON Pinza para esterilizar | 29 - 1 |
| QUINKE Aguja para puncion lumbar | 17 - 15 |

INDICE ESPAÑOL

R

| | |
|-------------------------------------|-------------|
| Raccords | 17 - 16; 17 |
| RADOLF Pinza para arrancar unas | 25 - 3 |
| RAGNELL-DAVIS Separador doble agudo | 13 - 6 |
| RAMPLEY Pinza para esponjas | 07 - 5 |
| RANDALL Cureta para biopsia | 23 - 24 |
| RANDALL Pinza calculos renal | 19 - 1 |
| RECAMIER Cureta uterinals | 23 - 26; 28 |
| REKTAL Tijera para cirugía | 03 - 27 |
| Resorte capirote | 17 - 16 |
| Retractor lateral vaginal | 23 - 14 |
| REVERDIN Aguja | 11 - 22 |
| REVERDIN Separador abdominal | 15 - 25 |
| REYNOLDS Tijeras de diseccion | 03 - 43 |
| RIBBON Separador | 15 - 25 |
| RICARD Separadores abdominales | 15 - 14 |
| RICHARDSON Separador | 13 - 18 |
| RICHARDSON-EASTMAN Separador | 13 - 19 |
| RICHTER Separador | 15 - 10 |
| RICHTER-HEATH Pinza para grapas | 11 - 31 |
| Rinoneras | 29 - 2 |
| ROBERTS Pinza hemostatica | 09 - 14 |
| Robinets | 17 - 16 |
| ROBIN-MASSE Separador abdominal | 15 - 15 |
| ROBIN-MASSE Valva lateral | 15 - 15 |
| ROCHARD Bastidor para la fijación | 15 - 24 |
| ROCHARD Separadores abdominales | 15 - 24 |
| ROCHESTER-CARMALT Pinza hemostatica | 09 - 12 |
| ROCHESTER-PEAN Pinza hemostatica | 09 - 13 |
| ROEDER Pinza para campos | 07 - 1 |
| ROGGE Pinza para esterilizar | 29 - 1 |
| ROUX Separador | 13 - 10 |
| ROUX Separador, mini | 13 - 11 |
| ROUX-BABY Separador | 13 - 11 |
| RUDD Ligator para hemorroides | 21 - 16 |
| RUDD Pinza para hemorroides | 21 - 17 |
| RUMEL Pinza toracica | 09 - 16 |
| RYDER Porta agujas | 11 - 14 |
| RYDER Vascular porta aguja | 11 - 13 |

S

| | |
|--------------------------------------|-------------|
| SAALFELD Extractores para comedones | 25 - 2 |
| SAENGER Pinza para aborto y placenta | 23 - 37; 38 |
| SANVENERO Tijeras de diseccion | 03 - 13 |
| SAROT Pinza Clamp bronquial | 09 - 14 |
| SAROT Porta aguja | 11 - 11 |
| SAUERBRUCH Separador | 13 - 17 |
| SCALP-CONTOUR Separador | 15 - 2 |
| SCHAMBERG Extractores para comedones | 25 - 2 |
| SCHEDE Cucharilla cortante | 27 - 1 |
| SCHERBAK Especulo vaginales | 23 - 4 |
| SCHINK Dermatomo | 01 - 11 |
| SCHINK Placa para extender la piel | 01 - 10 |
| SCHMID Canula de irrigacion vascular | 17 - 14 |

| | |
|--|--|
| SCHMID Canula vascular | 17 - 14 |
| SCHMIEDEN Aguja ligadura | 11 - 25 |
| SCHMIEDEN Sonda conductora | 11 - 29 |
| SCHMIEDEN-PAYR Sonda conductora | 11 - 29 |
| SCHMIEDEN-TAYLOR Tijeras duramadre | 03 - 20 |
| SCHNIDT-SAWTELL Pinza para amigdalas | 09 - 11 |
| SCHROEDER Pinza uterina | 23 - 18 |
| SCHUBERT Pinza para biopsia | 23 - 33 |
| SCHUKNECHT Separador | 15 - 3 |
| SCHUMACHER Pinza para biopsia | 23 - 33 |
| SCHUMACHER Tijeras para cordon umbilical | 03 - 28 |
| SCHUMACHER-VAN DOREN Pinzas para biopsie | 23 - 32 |
| SCHWED MOD. Vascular porta aguja | 11 - 14 |
| SCUDDER Pinza intestinales | 21 - 10 |
| SEDILLOT Periostotomo | 27 - 6 |
| SEGOND bisturí para fibroma | 23 - 25 |
| SELDINGER Luer Lock canula para biopsia | 17 - 13 |
| SELETZ-GELPI Separador perineal | 15 - 7 |
| SEMB Pinza bronquial | 09 - 25 |
| SEMKEN Pinza estriada curva | 05 - 4 |
| SEMKEN Pinza quirurgica | 05 - 10 |
| SEMM | |
| Cuadro suelto | 15 - 23 |
| Especulo vaginales | 23 - 3 |
| Valva (intestinal) | 15 - 23 |
| Separador | 13 - 6 |
| SENN-GREEN Separador | 13 - 5 |
| SENN-MILLER-BABY Separador | 13 - 6 |
| Separador | 13 - 1; 3-6; 10-25; 27; 15 - 1-7; 9-11; 25 |
| (parpados) | 13 - 7 |
| (scapula) | 13 - 27 |
| abdominal | 13 - 19; 15 - 14-25 |
| agudo a resorte | 13 - 3 |
| autorretentivo | 15 - 1; 2; 7-9; 12; 13; 27 |
| autorretentivo para laminectomia | 15 - 10 |
| costal | 15 - 26; 27 |
| cysticus | 21 - 17 |
| mini | 13 - 5; 11 |
| para la vejiga | 19 - 6 |
| para nervios | 13 - 4 |
| pelvicos | 13 - 27 |
| perineal | 15 - 7 |
| prostatico | 19 - 8 |
| rectal | 21 - 12 |
| toracica | 13 - 4 |
| vaginales | 15 - 10 |
| SHORTBENT Tijera para ligaduras | 03 - 18 |
| SIEBOLD Tijeras ginecologia | 03 - 25 |
| Sierra para abrir anillos | 25 - 3 |

| | | | |
|--|-------------|---|---------------------------------|
| SILVER Dermatomo manual | 01 - 11 | TEALE Pinza uterina | 23 - 19 |
| SIMON | | Tenedor para ligadura en profund | 11 - 31 |
| Cuchara uterinas cortante | 23 - 32 | TERRIER Pinza hemostática recta | 09 - 5 |
| Gancho para fistulas | 23 - 25 | THOMS-ALLIS Pinza intestinales | 21 - 3 |
| Separador abdominal | 13 - 21 | THOMS-GAYLOR Pinza para biopsia | 23 - 32; 33 |
| SIMPSON Histerometro | 23 - 23 | THOMSON-WALKER Separador para la vejiga | 19 - 6 |
| SIMPSON-BRAUN Forceps obstetricos | 23 - 35 | THOREK Tijera pulmonologie (toracica) | 3 - 13 |
| SIMPSON-LUIKART Forceps obstetricos | 23 - 35 | Tijeras | |
| SIMS | | de disección | 03 - 6-11; 13; 28; 34-36; 41-43 |
| Curetas uterinas | 23 - 27; 29 | de diseccion, micro | 03 - 46 |
| Depresor uterino | 23 - 22 | duramadre | 03 - 20 |
| Especulo rectal | 21 - 12 | finas de disección | 03 - 9; 44 |
| Especulo vaginales | 23 - 10; 11 | ginecologicas | 03 - 25; 26 |
| Histerometro | 23 - 22; 23 | intestinales | 03 - 24 |
| Tijeras para el utero | 03 - 37 | micro | 03 - 45-47; 51 |
| SINGLEY-TUTTLE Pinzas de diseccion | 05 - 5 | nas para quirurgica, fino | 03 - 14; 16; 17 |
| SKENE Pinza para cuello uterino | 23 - 19 | nasales | 03 - 19; 20; 44 |
| SMITH-BUIE Separador rectal | 21 - 12 | neuroquirurgicas | 03 - 17; 18 |
| SMITH-PETERSEN Gubia | 27 - 10 | para alambre | 03 - 40 |
| SÖKELAND Pinza calculos biliares | 19 - 2 | para amigdalas | 03 - 20; 21 |
| SOMER Pinza histerolabo | 23 - 21 | para anatomia | 03 - 27 |
| Sonda | | para cartilago | 03 - 21; 24 |
| acanalada | 17 - 1; 2 | para cirugía plástica | 03 - 12; 13 |
| acanalada abotonada | 17 - 2 | para cordon umbilical | 03 - 28 |
| auricular plata | 17 - 1 | para enterotomia | 03 - 26 |
| calculos biliares | 19 - 3; 4 | para episiotomia dentadas | 03 - 28 |
| conductora | 11 - 28-30 | para estrabismo | 03 - 14; 42 |
| para bocio | 11 - 30 | para Face-lift | 03 - 41 |
| para varices | 17 - 4 | para fístulas | 03 - 26 |
| SPENCER Tijeras para ligaduras | 03 - 19 | para incisiones | 03 - 17 |
| SPENCER-WELLS Pinza hemostatica | 09 - 6 | para iridectomia | 03 - 15 |
| ST. MARKS Separador pelvicos | 13 - 27 | para ligaduras | 03 - 18; 19 |
| STACKE Sonda auricular plata | 17 - 1 | para lobectomía | 03 - 27 |
| STAUDE-MOORE Pinza para cuello uterino | 23 - 17 | para lobectomía y recto | 03 - 27 |
| STELZNER Tijeras para lobectomía y recto | 03 - 27 | para preparacion de nervios | 03 - 13 |
| STEVENS Tijera para tendones | 03 - 14 | para quirurgica | 03 - 1-6; 17; 31; 32; 42 |
| STEVENS Tijera, micro | 03 - 47 | para tendones | 03 - 14; 43; 45 |
| STILLE | | para vendajes | 03 - 29; 30 |
| Escoplos | 27 - 8 | para yesos | 03 - 30 |
| Gubia | 27 - 9 | para, IRIS | 03 - 40; 43 |
| Osteotomo | 27 - 8 | pulmonologie (toracica) | 03 - 13; 24 |
| Pinza estriada | 05 - 3 | uterinas | 03 - 5; 23; 24; 32; 37 |
| Pinza para pediculo renal | 09 - 23 | vasculares | 03 - 20; 22-24; 38; 39; 44 |
| Pinza quirurgica | 05 - 9 | Tijeras vasculares, micro | 03 - 51 |
| STOCKMANN Pinza para el penis | 19 - 10 | TISCHLER-BABY Pinzas para biopsia | 23 - 34 |
| STRABISMUS Tijeras | 03 - 42 | TISCHLER-KEVORKIAN Pinza para biopsia | 23 - 34 |
| STRATTE Porta aguja | 11 - 5; 17 | TISCHLER-MORGAN Pinza para biopsia | 23 - 34 |
| STRAUSS Pinza para el penis | 19 - 10 | TOENNIS Pinza hemostatica | 09 - 18 |
| STRULLY Tijera neuroquirurgicas | 03 - 18 | TOENNIS Porta aguja | 11 - 17 |
| SYME Aguja ligadura | 11 - 24 | | |
| T | | | |
| Tarros metalicos | 29 - 2 | | |
| TAYLOR | | | |
| Pinza de diseccion | 05 - 3 | | |
| Pinza de diseccion estriada | 05 - 3 | | |
| Pinza quirurgica | 05 - 10 | | |

INDICE ESPAÑOL

| | | | |
|--|--|--|--|
| TOENNIS-ADSON | | | |
| Tijera de diseccion | 03 - 10 | | |
| Tijeras fino | 03 - 35 | | |
| Tijera neuroquirurgicas | 03 - 17 | | |
| TOHOKU Pinza para campos | 07 - 3 | | |
| TRELAT Aguja | 11 - 27 | | |
| TREVES Pinza quirurgica | 05 - 13 | | |
| Trocar | 17 - 5-7 | | |
| Trocar abdominal | 17 - 5 | | |
| Trocar seno maxilar | 17 - 7; 8 | | |
| Trocar y canula | 17 - 8 | | |
| Tubo de aspiracion | 17 - 8-11 | | |
| TUFFIER Pinza hemostatica | 09 - 3 | | |
| TUFFIER Separadores costales | 15 - 26 | | |
| TUOHY Agujas para punción lumbar | 17 - 15 | | |
| TURNER-WARWICK Modif. Separadores abdominales | 15 - 19 | | |
| TURNER-WARWICK Pinza calculos biliares | 19 - 2 | | |
| U | | | |
| UCKERMANN Porta-algodon | 17 - 3 | | |
| ULRICH Pinza de curacion y para torundas | 07 - 4 | | |
| Universal tijeras para alambre | 03 - 29 | | |
| Universal trocar | 17 - 5 | | |
| UNNA Extractores para comedones | 25 - 2 | | |
| Uro-tangencial pinza | 09 - 24 | | |
| US Army Separador doble pareja | 13 - 12 | | |
| V | | | |
| VALLEIX Histerometro | 23 - 23 | | |
| Valva | 15 - 12; 13; 15; 18; 20-23; 19 - 6; 21 - 13 | | |
| Valva (intestinal) | 15 - 23 | | |
| Valva intercambiable | 15 - 14 | | |
| Valva vaginal | 23 - 5 | | |
| VAN BUREN Bujia dilatadora | 19 - 9 | | |
| VERESS Agujas aspirazione | 17 - 13 | | |
| VERESS Agujas para insuflacion | 17 - 13 | | |
| VIRCHOW Cuchillo para cerebro mango hueco | 01 - 9 | | |
| VOLKMANN Cucharilla cortante | 27 - 1; 3 | | |
| VOLKMANN Separador | 13 - 13 | | |
| W | | | |
| WACHENFELDT Pinza para grapas | 11 - 31 | | |
| WAGNER Tijeras fino | 03 - 14 | | |
| WALB Cuchillo para órganos hoja | 01 - 9 | | |
| WALDMANN Tijeras para episiotomia | 03 - 28 | | |
| WALLICH Cuchara para aborto | 23 - 38 | | |
| WALTON Extractores para comedones | 25 - 2 | | |
| WANGENSTEEN Pinza | 05 - 19 | | |
| WANGENSTEEN Porta agujas | 11 - 4; 15 | | |
| WATSON-CHEYNE Elevador | 27 - 4 | | |
| WAUGH Pinza de diseccion | 05 - 5 | | |
| WAUGH Pinza quirurgica | 05 - 11 | | |
| WEBSTER Porta aguja | 11 - 10 | | |
| WEISSBARTH Especulos vaginales | 23 - 3 | | |
| WEITLANER Separador | 15 - 5 | | |
| WEITLANER-BABY Separador | 15 - 7 | | |
| WEITLANER-LOKTITE Separador | 15 - 5 | | |
| WERTHEIM Especulo vaginales | 23 - 12 | | |
| WERTHEIM Pinza histerectomia/ligadura | 09 - 27 | | |
| WERTHEIM-CULLEN Pinza para histerectomia | 09 - 27 | | |
| WESTCOTT Tijera tenotomia | 03 - 45 | | |
| WIKSTROEM Pinza diseccion/ligadura | 09 - 19 | | |
| WILLAUER Tijeras para lobectomía y recto | 03 - 27 | | |
| WILLET MARTEL Pinza pericraneo | 09 - 4 | | |
| WILLIAMS Pinza para tejido intestinales | 21 - 3 | | |
| WILLIGER | | | |
| Cucharilla cortantes | 27 - 3 | | |
| Elevador | 27 - 4 | | |
| Periostot | 27 - 6 | | |
| WINTER Pinza para aborto y placenta | 23 - 37 | | |
| WITTNER Pinza para biopsia | 23 - 33 | | |
| WRIGLEY Forceps obstetricos | 23 - 35 | | |
| WULLSTEIN Separador | 15 - 3 | | |
| Y | | | |
| YANKAUER Tubo de aspiracion | 17 - 9 | | |
| YEOMAN Pinza biopsia rectal | 21 - 16 | | |
| YOUNG Aguja de repuesto | 11 - 26 | | |
| YOUNG Separador prostatico | 19 - 8 | | |
| Z | | | |
| ZENKER Pinza disseccion/ligatura | 09 - 20 | | |
| ZENKER Separador | 13 - 23 | | |
| ZWEIFEL Porta aguja | 11 - 20 | | |

СОДЕРЖАНИЕ РУССКИЙ



| | Страница | | Страница |
|---|-----------------|---|----------------|
| А | | | |
| Абортные кюретки | 23 - 37 | БЕРНАРД (BERNHARD) Зажимы для операционного белья | 07 - 2 |
| Абортные ложки | 23 - 38 | БЁТТЧЕР (BOETTCHER) Ножницы назальные | 03 - 21 |
| Абортные щипцы | 23 - 21; 37; 38 | БЕХАМ (BEACHAM) Амниотомы | 23 - 22 |
| АДЛЕРКРЕУТЗ (ADLERKREUTZ) Пинцеты хирургические | 05 - 9 | БИЕР (BIER) Иглы пункционные поясничные | 17 - 14 |
| АЙВИС ФЭНСЛЕР (IVES FANSLER) Анускопы | 21 - 15 | БИНГОЛИА (BENGOLEA) Зажимы артериальные | 09 - 13 |
| АЛЕКСАНДЕР (ALEXANDER) Долота | 27 - 9 | Биопсийные выкусыватели кожные | 23 - 32; 33 |
| АЛЕКСАНДЕР (ALEXANDER) Щипцы биопсийные цервикальные | 23 - 33 | Биопсийные канюли | 17 - 13; 15 |
| АЛЛПОРТ (ALLPORT) Ранорасширители | 15 - 1 | Биопсийные кюретки | 23 - 24 |
| АЛМ (ALM) Ранорасширители | 15 - 1 | Биопсийные щипцы | 23 - 16; 32-34 |
| Амниотомы (щипцы для вскрытия амниотического (плодного) пузыря) | 23 - 22 | Биопсийные щипцы маточные | 23 - 32-34 |
| Ампутационные ножи | 01 - 8; 10 | Биопсийные щипцы ректальные | 21 - 16 |
| Анатомический скальпель | 01 - 7 | БИРКЕТТ (BIRKETT) Зажимы перевязочные и лигатурные | 9 - 10 |
| Ангиотрибы | 09 - 5 | БЛЭЙК (BLAKE) Зажимы для желчных камней | 19 - 2 |
| АНГЛИЙСКАЯ МОДЕЛЬ (ENGL. MOD.) Зажимы для операционного белья | 07 - 1 | БЛЭЙК (BLAKE) Кюретки маточные | 23 - 32 |
| АНДЕРСОН-ЭДСОН (ANDERSON-ADSON) Ранорасширители мозжечковые | 15 - 2 | БОЙС-ЭЛЛИС (BOYS-ALLIS) Зажимы кишечные и хирургические | 21 - 3 |
| Анускоп | 21 - 14; 15 | Боксы для инструментов | 23 - 15; 16 |
| Артериальные зажимы | 09 - 3-22 | БОНН (BONN) Ножницы | 03 - 16 |
| Атравматичные зажимы "бульдог" | 09 - 2; 3 | БОННИ (BONNEY) Пинцеты анатомические | 05 - 5 |
| Атравматичные зажимы кишечные для захватывания тканей | 21 - 1; 7 | БОННИ (BONNEY) Пинцеты хирургические | 05 - 20 |
| Атравматичные пинцеты | 05 - 18 | Боры для ногтей | 25 - 1 |
| АУВАРД (AUVARD) Зеркала вагинальные | 23 - 4 | БОЦЕМАНН (BOZEMANN) Зажимы для тампона | 07 - 3; 4 |
| Б | | Закручиватель петли (инструменты шовные) | 11 - 31 |
| БАГГИШ (BAGGISH) Маточные зажимы для взятия биопсии | 23 - 34 | Иглодержатели | 11 - 16 |
| БАДГЛЕЙ (BADGLEY) Ранорасширители | 15 - 27 | Ножницы гинекологические | 03 - 25 |
| БАК (BUCK) Ножницы для лигатуры | 03 - 19 | БРАЙАНТ (BRYANT) Корнцанги и зажимы для тампонов | 07 - 3 |
| БАРРАКУЕР (BARRAQUER) Микро-иглодержатель | 11 - 7 | БРАЙТУАЙТ (BRAITHWAITE) Дерматомы | 01 - 11 |
| БАРРАКУЕР-ТРУТМАН (BARRAQUER-TROUTMAN) Иглодержатель | 11 - 21 | БРАЙТУАЙТ (BRAITHWAITE) Запасные лезвия | 01 - 11 |
| БАРРАКУЕР-ТРУТМАН (BARRAQUER-TROUTMAN) Микро-иглодержатель | 11 - 7 | БРАУН (BRAUN) Депрессоры маточные | 23 - 22 |
| БАРРЕТТ (BARRETT) Щипцы маточные зубчатые | 23 - 17 | Зеркала вагинальные | 23 - 12 |
| Бачки для растворов и смесей | 29 - 2 | Щипцы маточные зубчатые | 23 - 18; 20 |
| БЕКМАН (BECKMANN) Ранорасширители | 15 - 8; 9 | БРАУН (BROWN) Иглодержатель | 11 - 2 |
| БЕКМАНН-ЭДСОН (BECKMANN-ADSON) Ранорасширители | 15 - 8 | БРАУН (BROWN) Пинцеты хирургические | 05 - 13 |
| БЕРГМАНН (BERGMANN) Молотки | 27 - 11 | БРАУН-СТАДЛЕР (BRAUN-STADLER) Ножницы для эпизиотомии | 03 - 28 |
| БЕРГМАНН (BERGMANN) Ножницы для гипсовых повязок | 03 - 29 | БРЕСКИ (BREISKY) Зеркала вагинальные | 23 - 8 |
| БЁРД (BYRD) Отсасывающие трубки | 17 - 10 | БРОДИ (BRODIE) Зонды | 17 - 1 |
| БЕРЛИН (BERLIN) Зажимы для трубок | 07 - 6 | Бронхиальные зажимы | 09 - 22; 25 |
| | | БРОФИ (BROPHY) Пинцеты анатомические | 05 - 5 |
| | | БРОФИ (BROPHY) Пинцеты хирургические | 05 - 11 |

| | | | |
|---|-------------|---|---------------|
| БРОФИ-САЛЛИВАН (BROPHY-SULLIVAN)) Ножницы | 03 - 17 | БЭРРИ СТЕРНАЛ (BARRY STERNAL) Зажимы для кручённой нити | 11 - 16 |
| БРУННЕР (BRUNNER) | | В | |
| Зажимы кишечные атравматические | 21 - 8 | Вагинальные зеркала | 23 - 1-12; 14 |
| Зонды лигатурные | 11 - 28 | Вагинальные самоудерживающиеся расширители | 15 - 10 |
| Иглы лигатурные | 11 - 25 | ВАГНЕР (WAGNER) Ножницы тонкие | 03 - 14 |
| Ранорасширитель | 13 - 24 | ВАЙЛЛИГЕР (WILLIGER) | |
| БРУННЕР-ФЕРРОЗЕЛЛ (BRUNNER- FERROZELL) Зонды лигатурные | 11 - 30 | Кюретки костные | 27 - 3 |
| БРУНС (BRUNS) Кюретки костные | 27 - 1 | Распаторы для снятия надкостницы | 27 - 4; 6 |
| БРУНС (BRUNS) Ножницы для гипсовых повязок | 03 - 30, 40 | Элеваторы | 27 - 4 |
| БРЭЙНБРИДЖ (BAINBRIDGE) | 09 - 12 | ВАЛБ (WALB) Ножи мозговые | 01 - 9 |
| Зажимы артериальные | | ВАЛДМАНН (WALDMANN) Ножницы для эпизиотомии | 03 - 28 |
| БУИЛАУ (BUELAU) Трояк | 17 - 6 | ВАЛЛИХ (WALLICH) Ложки абортные | 23 - 38 |
| БУММ (BUMM) Кюретки маточные | 23 - 30 | ВАЛЬТЕР-КАРМАЛЬТ (WALTER-CARMALT) Пинцеты костные | 05 - 15 |
| БУНТ (BUNT) Щипцы и булавки стерилизационные | 29 - 1 | ВАН БУРЕН (VAN BUREN) Катетер для мочевых путей | 19 - 9 |
| БУРКЕ (BURKE) Щипцы биопсийные цервикальные | 23 - 34 | ВАНГЕНШТИН (WANGENSTEEN) | 11 - 4; 15 |
| БУШ (BUSCH) Ножницы для пуповины | 03 - 28 | Иглодержатели | |
| БЭБКОК (BABCOCK) Кишечные зажимы для захватывания тканей, атравматические | 21 - 4 | ВАНГЕНШТИН (WANGENSTEEN) | 05 - 19 |
| БЭЙБИ-МЕТЦЕНБАУМ (BABY-METZENBAUM) | | Пинцеты хирургические | |
| Ножницы | 03 - 7 | Ванночки медицинские | 29 - 2; 3 |
| Ножницы анатомические | 03 - 43 | Ватоносители | 17 - 3 |
| Ножницы хирургические | 03 - 43 | ВАТСОН-ЧЕЙНЕ (WATSON-CHEYNE) Элеватор | 27 - 4 |
| БЭЙБИ-МИКСТЕР (BABY-MIXTER) Зажимы артериальные | 09 - 6 | ВАХЕНФИЛТ (WACHENFELDT) Зажимы шовные | 11 - 31 |
| БЭЙБИ-МИКСТЕР (BABY-MIXTER) Зажимы перевязочные и лигатурные | 09 - 15 | ВЕБСТЕР (WEBSTER) Иглодержатели | 11 - 1; 10 |
| БЭЙБИ-МИКУЛИЧ (BABY-MIKULICZ) Зажимы перитональные | 09 - 25 | ВЕЙССБАРТ (WEISSBARTH) Зеркала вагинальные | 23 - 3 |
| БЭЙБИ-ОВЕРХОЛТ (BABY-OVERHOLT) Зажимы артериальные | 09 - 9 | ВЕЙТЛАНЕР (WEITLANER) Ранорасширители самоудерживающиеся | 15 - 5; 6 |
| БЭЙБИ-РОУКС (BABY-ROUX) Крючки | 13 - 11 | ВЕЙТЛАНЕР-ЛОКТИТ (WEITLANER- LOKTITE) Ранорасширители | 15 - 5 |
| БЭЙБИ-СЕНН-МИЛЛЕР (BABY-SENN-MILLER) Крючки | 13 - 6 | ВЕЙТЛЭНЕР-БЭЙБИ (WEITLANER-BABY) Ранорасширители | 15 - 7 |
| БЭЙБИ-ТИШЛЕР (BABY-TISCHLER) Щипцы биопсийные цервикальные | 23 - 34 | ВЕРЕШ (VERRES) Иглы специальные | 17 - 13 |
| БЭЙБИ-ЭДСОН (BABY-ADSON) Зажимы артериальные | 09 - 15 | ВЕРЕШ (VERRES) Трубки отсасывающие | 17 - 13 |
| БЭЙКЕС (BAKES) Дилаторы желчного протока | 19 - 5 | ВЕРТЕЙМ (WERTHEIM) Вагинальные зеркала | 23 - 12 |
| БЭКХАУЗ (BACHHAUS) Зажимы для операционного белья | 07 - 1 | ВЕРТЕЙМ (WERTHEIM) Щипцы гистерэктомические | 09 - 26; 27 |
| БЭЛФОР (BALFOUR) Расширитель для брюшины | 15 - 17 | ВЕРТЕЙМ-КУЛЛЕН (WERTHEIM- CULLEN) Зажимы | 09 - 27 |
| БЭЛФОР (BALFOUR) Сменные лопатки | 15 - 18 | ВЕСТКОТТ (WESTCOTT) Ножницы для тенотомии | 03 - 45 |
| БЭЛФОР-БЭЙБИ (BALFOUR-BABY) Расширитель для брюшины | 15 - 18 | ВИКШТРЕМ (WIKSTROEM) Зажимы перевязочные и лигатурные | 09 - 19 |
| | | Вилка для шовного материала | 11 - 31 |
| | | ВИЛЛАУЭР (WILLAUER) Ножницы для лобэктомии | 03 - 27 |
| | | ВИЛЛЕТ-МАРТЕЛЬ (WILLET-MARTEL) Зажимы для кожи головы | 09 - 4 |
| | | ВИЛЛИАМС (WILLIAMS) Зажимы захватывающие кишечные | 21 - 3 |
| | | ВИНТЕР (WINTER) Щипцы абортные (абортцанги) | 23 - 37 |

СОДЕРЖАНИЕ РУССКИЙ

| | | | |
|--|---------------------|---|-----------------|
| Винты для миомы | 23 - 25 | ДЕ БЭКИ (DE BAKEY) | |
| ВИТТНЕР (WITTNER) Щипцы биопсийные | 23 - 33 | Зажимы "бульдог" атравматичные | 09 - 2 |
| ВО (WAUGH) Пинцеты анатомические | 05 - 5 | Иглодержатели | 11 - 13 |
| ВО (WAUGH) Пинцеты хирургические | 05 - 11 | Ножницы для кровеносных сосудов | 03 - 21; 23; 38 |
| ВУЛЛШТЕЙН (WULLSTEIN) Ранорасширители | 15 - 3 | Отсасывающие трубки | 17 - 9 |
| Выкусыватель биопсийный | 23 - 32-34 | Пинцеты атравматичные | 05 - 18 |
| ВЭЛТОН (WALTON) Экстракторы угрей | 25 - 2 | Пинцеты для кровеносных сосудов, атравматичные | 05 - 18 |
| Г | | Ранорасширители | 15 - 9 |
| Геморроидальные зажимы | 09 - 4; 5 | ДЕ ЛА РОЗА (DE LA ROZA) Иглы лигатурные | 11 - 26 |
| Геморроидальные захватывающие щипцы | 21 - 17; 23 - 21 | ДЕ МАРТЕЛЬ-ВОЛЬФСОН (DE MARTEL-WOLFSON) Держатели для зажимов | 21 - 9 |
| Геморроидальные лигаторы | 21 - 16 | ДЕ МАРТЕЛЬ-ВОЛЬФСОН (DE MARTEL-WOLFSON) Зажимы для колоанального анастомоза | 21 - 9 |
| ГИЛ-ВЕРНЕТ (GIL-VERNET) Крючки | 13 - 9 | Депрессоры маточные | 23 - 22 |
| ГИЛЛИС (GILLIES) Иглодержатели / Ножницы | 11 - 17 | Держатели брюшины | 15 - 14-23 |
| Крючки мозговые и кожные | 13 - 1 | Держатели вагинального зеркала | 23 - 5 |
| Пинцеты хирургические | 05 - 9; 20; 13 - 1 | Держатели века | 13 - 7 |
| ГИЛПИ (GELPI) Ранорасширители | 15 - 7 | Держатели зажимов | 21 - 9 |
| ГИЛПИ-ЛОКТИТ (GELPI-LOKTITE) Ранорасширители | 15 - 7 | Держатели шовного материала | 11 - 31 |
| Гинекологические ножницы | 03 - 11; 24; 25; 37 | ДЕСДЖАРДИНС (DESJARDINS) Зажимы для желчных камней | 19 - 1 |
| ГЛОВЕР (GLOVER) Зажимы "бульдог" атравматичные | 09 - 3 | Зажимы для желчного протока | 09 - 21 |
| ГЛЭССМЭН (GLASSMAN) Зажимы кишечные | 21 - 8 | Ложки для удаления жёлчных конкрементов | 19 - 4 |
| ГОИЛИТ (GOELET) Крючки двусторонние | 13 - 12 | ДЕСМАРРИС (DESMARRES) Крючки | 13 - 7 |
| ГОМЕЛЬ (GOMEL) Микро-иглодержатели | 11 - 7 | ДЕСМАРРИС (DESMARRES) Ранорасширители | 13 - 7 |
| ГОССЕТ (GOSSET) Ранорасширители брюшные | 15 - 16 | ДЖЕВЕЛЕС (JEWELER'S) Пинцеты | 05 - 17 |
| ГРИН-ЭРМИТЭДЖ (NAEGELE) Щипцы кровоостанавливающие, для кесарева сечения | 23 - 36; 37 | ДЖЕКСОН БУРРОУС (JACKSON BURROWS) Ранорасширители | 15 - 10 |
| ГРОСС-МАЙЕР (GROSS-MAIER) Зажимы анатомические | 07 - 5 | ДЖЕМИНИ (GEMINI) Зажимы перевязочные и лигатурные | 09 - 19 |
| ГРЭЙ (GRAY) Зажимы для желчного протока | 09 - 22 | ДЖЕНСЕН (JANSEN) Кюретки костные | 27 - 3 |
| ГРЭЙВ (GRAVE) Зеркала вагинальные | 23 - 3 | ДЖЕНСЕН (JANSEN) Ранорасширители острые | 15 - 1 |
| ГРЭФ (GRAEFE) Крючки тонкие | 13 - 1 | ДЖЕРАЛЬД (GERALD) Пинцеты анатомические | 05 - 3; 4; 20 |
| ГРЭФ-ИРИС (GRAEFE IRIS) Пинцеты | 05 - 16; 17 | ДЖЕРАЛЬД (GERALD) Пинцеты хирургические | 05 - 20 |
| ГУД (GOOD) Ножницы назальные | 03 - 21 | ДЖОБСОН-ХОРНЕ (JOBSON-HORNE) Ватоносители | 17 - 3 |
| ГУЙОН (GUYON) Дилататорный катетер | 19 - 10 | ДЖОЗЕФ (JOSEPH) Крючки кожные | 13 - 1 |
| Зажимы для почечной ножки | 09 - 23 | Ножницы для пластической хирургии | 03 - 13 |
| Катетер | 19 - 10 | Ранорасширители тонкие | 13 - 2 |
| ГУТРИ (GUTHRIE) Крючки тонкие | 13 - 2 | ДЖОЛЛ (ФРИДМАН) (JOLL (FRIEDMAN)) Ранорасширители вагинальные | 15 - 10 |
| ГЭРЛЭНД (GARLAND) Щипцы гистерэктомические | 09 - 28 | ДЖОНС (JONES) Зажимы для операционного белья | 07 - 1 |
| Д | | ДЖОНС-ХОПКИНС (JOHNS HOPKINS) Зажимы "бульдог" | 09 - 1 |
| ДАУБЕНШПЕК (DAUBENSPECK) Кюретки костные | 27 - 2 | | |

| | |
|--|-------------|
| ДЖОНС-ХОПКИНС (JOHNS HOPKINS) Зажимы артериальные | 09 - 15 |
| ДЖОНСОН (JOHNSON) Иглодержатели | 11 - 4 |
| ДЖУД-МЭССОН (JUDD-MASSON) Зеркала для мочевого пузыря | 19 - 6 |
| ДЖУД-ЭЛЛИС (JUDD-ALLIS) Зажимы кишечные и хирургические | 21 - 2 |
| ДЖЭБАЛИ (JABALEY) Ножницы хирургические | 03 - 42 |
| ДЖЭКСОН (JACKSON) Зеркала вагинальные | 23 - 9 |
| ДЖЭМИСОН (JAMISON) Иглодержатели | 11 - 4 |
| ДЖЭМИСОН (JAMISON) Ножницы анатомические | 03 - 42 |
| ДИ ЛИ (DE LEE) Щипцы акушерские | 23 - 35 |
| ДИКСОН-ЛОВЕЛАС (DIXON-LOVELACE) Зажимы артериальные | 09 - 10 |
| Диляторы желчного протока | 19 - 5 |
| ДИРФ (DERF) Иглодержатели | 11 - 1; 10 |
| ДИРФ-КОНВЕРС (DERF-CONVERSE) Иглодержатели | 11 - 1 |
| ДИТРИХ (DIETRICH) Микро-иглодержатели | 11 - 10 |
| ДИТРИХ-ХЕГЕМАНН (DIETRICH- HEGEMANN) Ножницы для кровеносных сосудов | 03 - 44 |
| ДИТТЕЛЬ (DITTEL) Катетер для мочевых путей | 19 - 9 |
| ДИФФЕНБАХ (DIEFFENBACH) Зажимы "бульдог" | 09 - 1 |
| ДИФФЕНБАХ (DIEFFENBACH) Скальпель | 01 - 7 |
| ДИШАМПС (DESCHAMPS) Иглы лигатурные | 11 - 23; 24 |
| ДОЙЕН (DOYEN) Винты для миомы | 23 - 25 |
| Держатель брюшной | 13 - 19 |
| Держатель для зеркал вагинальных | 23 - 12 |
| Зажимы кишечные | 21 - 5; 6 |
| Зеркала вагинальные | 23 - 7 |
| Зонды | 17 - 1 |
| Ножницы брюшные | 03 - 25 |
| Ранорасширители | 15 - 19; 24 |
| Распаторы для снятия надкостницы | 27 - 6 |
| Щипцы для удаления полипов и абортные (абортцанги) | 23 - 21 |
| ДОЙЕН-БЭЙБИ (DOYEN-BABY) Зажимы кишечные | 21 - 5 |
| ДОЙЕН-СТАЙЛ (DOYEN-STILLE) Ранорасширители-крючки | 13 - 20 |
| Долота для костей | 27 - 7-10 |
| ДУБОИС (DUBOIS) Ножницы для цефалотомии | 03 - 26 |
| ДУГАЛС (DOUGALS) Троякары | 17 - 8 |
| ДЭВЕР (DEAVER) Ножницы хирургические | 03 - 2 |
| ДЭВЕР (DEAVER) Ранорасширители | 13 - 25-27 |

| | |
|---|--------------------|
| ДЭВИДСОН (DAVIDSON) Зеркала хирургические | 13 - 27 |
| ДЭВИДСОН (DAVIDSON) Троякары с ирригационной трубкой | 17 - 6 |
| ДЭНДИ (DANDY) Зажимы артериальные | 09 - 9 |
| ДЭНДИ (DANDY) Ножницы нейрохирургические | 03 - 18 |
| ДЭННИС-БРАУН (DENNIS-BROWN) Расширитель для брюшины | 15 - 20 |
| ДЭРТИГУЕС (DARTIGUES) Зажимы для матки | 23 - 21 |
| ДЮВАЛЬ (DUVAL) Кишечные зажимы для захватывания тканей | 21 - 4; 5 |
| ДЮВАЛЬ (DUVAL) Щипцы кишечные | 05 - 12 |
| ДЮПЛЭЙ (DUPLAY) Щипцы маточные зубчатые | 23 - 18 |
| ДЮХРСЕН (DUEHRSEN) Пинцеты анатомические | 05 - 5 |
| ДЮХРСЕН (DUEHRSEN) Пинцеты хирургические | 05 - 12 |
| Ё | |
| ЁНГ (YOUNG) Зеркала для предстательной железы | 19 - 8 |
| ЁНГ-ХРИНТШАК (YOUNG-HRYNTSCHAK) Иглодержатели | 11 - 26 |
| Ж | |
| Жгуты стекловолоконные для зеркал анальных | 21 - 15 |
| Желудочные зажимы | 21 - 9; 10 |
| З | |
| Зажимы | |
| абортные | 23 - 21; 37; 38 |
| артериальные | 09 - 3-22 |
| бронхиальные | 09 - 22; 24; 25 |
| бронхиальные захватывающие | 09 - 24 |
| "бульдог" | 09 - 1-3 |
| "бульдог" атравматические | 09 - 3; 2 |
| "бульдог" венозные | 09 - 2 |
| васкулярные | 09 - 1 |
| геморроидные | 09 - 4; 5 |
| геморроидные захватывающие для вен | 21 - 17 09 - 2 |
| для желчного протока | 09 - 14; 21; 22 |
| для желчных камней | 19 - 1; 2 |
| для захватывания тканей | 21 - 2; 3 |
| для кожи головы | 09 - 4 |
| для колоанального анастомоза | 21 - 9 |
| для кровеносных сосудов | 09 - 1 |
| для кручённой нити | 11 - 16 |
| для мочеиспускательного канала | 19 - 10 |

СОДЕРЖАНИЕ РУССКИЙ

Зажимы

| | |
|--|---------------------------|
| для накладывания и снятия зажимов типа "бульдог" | 09 - 1 |
| для наложения хирургических скобок (клипаторы) | 11 - 31 |
| для операционного белья | 07 - 1 - 3 |
| для операционных тампонов | 07 - 3; 4 |
| для почечной ножки | 09 - 1; 23; 24 |
| для почечных камней | 19 - 1 |
| для стерилизации | 29 - 1 |
| для тампонов | 07 - 3; 4 |
| для трубок | 07 - 6 |
| желудочные | 21 - 9; 10 |
| захватывающие | 09 - 3 |
| зубчатые | 23 - 17-21 |
| кишечные | 21 - 1-10 |
| кишечные для разрушения | 21 - 9 |
| корнцанги | 07 - 4; 5 |
| лигатурные | 09 - 15; 18; 19; 22 |
| маточные | 23 - 21 |
| маточные биопсийные | 23 - 32-34 |
| маточные захватывающие | 23 - 21; 22 |
| назальные | 09 - 11 |
| перевязочные | 09 - 6; 10; 16; 18-20 |
| перевязочные и лигатурные | 09 - 15 |
| перитональные | 09 - 25; 26 |
| сигмовидные для анастомоза | 21 - 11 |
| уро-тангеальные | 09 - 24 |
| хирургические | 09 - 6; 10; 16; 18-20; 22 |
| шовные | 11 - 31; 32 |
| Закручиватель петли (инструменты шовные) | 11 - 31 |
| Запасные лезвия | 01 - 11 |
| Запорный кран | 17 - 16; 17 |
| Захватывающие пинцеты | 05 - 5; 12 |
| ЗЕНГЕР (SÄNGER) Щипцы для плаценты и аборттов (абортцанги) | 24 - 37; 38 |
| ЗЕНКЕР (ZENKER) Зажимы анатомические | 09 - 20 |
| ЗЕНКЕР (ZENKER) Ранорасширитель | 13 - 23 |
| Зеркала | |
| внутренние | 23 - 13 |
| вагинальные | 23 - 1-12; 14 |
| ректальные | 21 - 12 |
| для мочевого пузыря | 19 - 8 |
| для предстательной железы | 19 - 8 |
| Зонды | |
| внутриматочные | 23 - 14 |
| для желчного протока | 19 - 3; 4 |
| желобковатые | 17 - 1; 2; 28 |
| лигатурные | 11 - 29; 30 |
| маточные | 23 - 22; 23 |
| с кнопочной головкой | 17 - 1; 30 |
| ушные | 17 - 1 |

И

| | |
|--|-----------------|
| Иглодержатели | 11 - 1-21 |
| Иглодержатели, микро- | 11 - 7-10; 20 |
| Иглодержатели / Ножницы | 11 - 5 |
| Иглы | |
| для неба | 11 - 27 |
| лигатурные | 11 - 15; 22-27 |
| пункционные | 17 - 12; 14; 15 |
| пункционные поясничные | 17 - 14; 15 |
| специальные | 17 - 12 |
| ИЗРАИЛЬ (ISRAEL) Крючки острые | 13 - 14 |
| ИММЕТ (EMMET) Крючки для фистулы | 23 - 25 |
| Инструментальный бокс (шовные инструменты) | 11 - 32 |
| Инструментальный бокс | 29 - 3 |
| Инструменты для обрезания | 19 - 10 |
| Инструменты шовные | 11 - 32 |
| Иригационные канули | 17 - 12 |
| ИРИС (IRIS) | |
| Ножницы | 03 - 15; 43 |
| Ножницы тонкие хирургические | 03 - 15; 40 |
| Пинцеты | 05 - 16; 17 |
| ИРЛЭНГЕНМОД (MILAN) Свёрла маточные | 23 - 25 |

Й

| | |
|--|---------|
| ЙОВА (IOWA) Отсасывающие трубки | 17 - 12 |
| ЙОВА (IOWA) Щипцы для амниотического (плодного) пузыря | 23 - 20 |
| ЙОМАН (YEOMAN) Щипцы ректальные, биопсийные | 21 - 16 |

К

| | |
|--|-------------|
| Кабель гибкий, стальной | 17 - 4 |
| КАЙЕ (KAYE) Ножницы для пластической операции | 03 - 41 |
| КАЛЛМОРГЕН (KALLMORGEN) Зеркала вагинальные | 23 - 9 |
| КАЛТ (KALT) Микро-иглодержатели | 11 - 10 |
| КАМПБЕЛЛ (CAMPBELL) Катетеры мочевых путей | 19 - 10 |
| КАМПБЕЛЛ (CAMPBELL) Троакары | 17 - 7 |
| КАН (KAN) Щипцы маточные зубчатые | 23 - 18 |
| КАНТРОВИТЦ (KANTROWITZ) Зажимы перевязочные и лигатурные | 09 - 19 |
| Канюли биопсийные | 17 - 13; 15 |
| Канюли ирригационные | 17 - 12 |
| Канюли пункционные, стерильные | 17 - 12 |
| КАПЛАН (CAPLAN) Ножницы назальные | 03 - 20 |
| КАРРЕЛ (CARREL) Артериальные клеммы | 09 - 5 |
| КАСТРОВИДЖО (CASTROVIEJO) Микро-иглодержатели | 11 - 8 |
| КАСТРОВИДЖО (CASTROVIEJO) Иглодержатели | 11 - 21 |
| Катетер дилататорный | 19 - 10 |

| | |
|--|--------------|
| Катетер для мочевых путей | 19 - 9 |
| Катетеры-расширители | 19 - 10 |
| КАТЛИН (CATLIN) Ампутационные ножи | 01 - 8 |
| КЕВОРКЯН (KEVORKIAN) Кюретки биопсийные | 23 - 24 |
| КЕВОРКЯН-ЁНГЕ (KEVORKIAN-YOUNGE) Щипцы биопсийные | 23 - 33 |
| КЕВОРКЯН-ПАСИФИК (KEVORKIAN-PACIFIC) Щипцы биопсийные цервикальные | 23 - 34 |
| КЕЙЕС (KEYES) Пробойники дерматологические | 25 - 1 |
| КЕЛЛИ (KELLY) | |
| Зажимы | 09 - 8 |
| Зажимы перевязочные и лигатурные | 09 - 18 |
| Зеркала хирургические | 13 - 18; 21 |
| Ножницы для фистулы | 03 - 26 |
| Проктоскопы | 21 - 14 |
| Сфинктероскопы | 21 - 14 |
| Щипцы для удаления полипов | 23 - 21 |
| КЕЛЛИ-РАНКИН (KELLY-RANKIN) Зажимы артериальные | 09 - 8 |
| КЁНИГ (KÖNIG) Зонды лигатурные | 11 - 29 |
| КЁНИГ (KÖNIG) Распаторы | 27 - 5 |
| КИЛЛЭНД (KIELLAND) Щипцы акушерские | 23 - 36 |
| КИЛНЕР (KILNER) | |
| Иглодержатели | 11 - 11 |
| Крючки кожные | 13 - 1 |
| Ножницы | 03 - 12 |
| Ножницы для пластической хирургии | 03 - 44 |
| КИРШНЕР (KIRSCHNER) Зонды лигатурные | 11 - 30 |
| КИРШНЕР (KIRSCHNER) Ранорасширители брюшные | 15 - 21; 22 |
| Кишечные зажимы | 21 - 2-8; 10 |
| Кишечные зажимы для захватывания тканей | 21 - 1-5 |
| Кишечные зажимы для разрушения | 21 - 9 |
| Кишечные ножницы | 03 - 26 |
| Кишечные пинцеты | 05 - 12 |
| КЛАЙМА-РОССЕГГЕР (KLIMA-ROSSEGGER) Канюли пункционные, стерильные | 17 - 12 |
| КЛАУС (CLAUS) Иглы лигатурные | 11 - 27 |
| КЛАУС-ЭЙКЕН (CLAUS-EICKEN) Иглы лигатурные | 11 - 27 |
| КЛЕЙНИРТ-КУТЦ (KLEINERT-KUTZ) Крючки тонкие | 13 - 1 |
| КЛИНКЕНБЕРГ-ЛОТ (KLINKENBERGH-LOTH) Ножницы для сосудов | 03 - 24 |
| КЛОВАРД модифицированный (CLOWARD Modif.) Ранорасширитель | 15 - 12; 13 |
| КЛОВАРД модифицированный (CLOWARD Modif.) Сменные лопатки | 15 - 12; 13 |
| КНАПП (KNAPP) Крючки тонкие | 13 - 3 |
| КОГАН (KOGAN) Зеркала внутренние | 23 - 13 |
| КОГСВЕЛЛ (COGSWELL) Отсасывающие трубки | 17 - 9 |

| | |
|---|-----------------|
| Кожные крючочки | 13 - 1 |
| Кожные кюретки | 25 - 1; 2 |
| КОИРТЕ (KOERTE) Крючки | 13 - 14 |
| КОКЛИ (COAKLEY) Троякары антральные | 17 - 7 |
| КОЛЛИЕР (COLLIER) Иглодержатели | 11 - 1 |
| КОЛЛИН (COLLIN) | |
| Зажимы для наложения хирургических скобок (клипаторы) | 11 - 31 |
| Зажимы для тампонов | 07 - 4 |
| Зажимы захватывающие | 09 - 3 |
| Зажимы захватывающие маточные | 23 - 22 |
| Зеркала вагинальные | 23 - 1 |
| Зонды маточные | 23 - 23 |
| Молотки | 27 - 11 |
| Ножи ампутационные | 01 - 8 |
| Ножи операционные | 01 - 6 |
| Ранорасширители брюшные | 15 - 15 |
| КОЛЛИН-БЭЙБИ (COLLIN-BABY) Ранорасширители брюшные | 15 - 14 |
| КОЛЛИН-ДЮВАЛЬ (COLLIN-DUVAL) Пинцеты захватывающие | 05 - 12 |
| Кортейнеры для игл | 29 - 3 |
| Конусы для зонда внутриматочного | 23 - 14 |
| КОППЕЛЬСОН (COPPELSON) Маточные биопсийные щипцы | 23 - 34 |
| Корзинки для хранения инструмента | 23 - 16 |
| КОРИККОС (CORYKKOS) Ранорасширители-крючки | 13 - 23 |
| Корнцанги | 07 - 4; 5 |
| КОТТЛ (COTTLE) Ножницы назальные | 03 - 20 |
| КОУПЛЭНД (COUPLAND) Отсывающие трубки, сменные | 17 - 9 |
| КОХЕН (COHEN) Зонды внутриматочные | 23 - 14 |
| КОХЕР (KOCHEK) | |
| Зажимы кишечные | 21 - 6; 7 |
| Зеркала для мочевого пузыря | 19 - 8 |
| Зеркала хирургические | 13 - 13; 17; 20 |
| Зонды лигатурные | 11 - 30 |
| Иглы лигатурные | 11 - 25 |
| КОХЕР (KOCHEK DELICATE) Тонкие артериальные зажимы | 09 - 12 |
| КОХЕР-ЛАНГЕНБЕК (KOCHEK-LANGENBECK) Зеркала хирургические | 13 - 16 |
| КОХЕТЕР (COXETER) Катетер | 19 - 9 |
| КРАУЗ (KRAUSE) Троякары | 17 - 8 |
| КРЁНЛЕЙН (KROENLEIN) Зажимы артериальные | 09 - 5 |
| КРИЛ (CRILE) Зажимы артериальные | 09 - 9 |
| КРИЛ-ВУД (CRILE-WOOD) Иглодержатели | 11 - 2; 11 |
| КРИЛ-МУРРЭЙ (CRILE-MURRAY) Иглодержатели | 11 - 2 |
| КРИЛ-РАНКИН (KELLY-RANKIN) Зажимы артериальные | 09 - 10 |
| КРИСТЕЛЛЕР (KRISTELLER) Зеркала вагинальные | 23 - 5; 9 |

СОДЕРЖАНИЕ РУССКИЙ

| | | | |
|--|--------------------|---|-------------|
| КРОНЕКЕР (KRONECKER) Иглы лигатурные | 11 - 26 | ЛАХИ (LANEY) Зажим для желчного протока | 09 - 21 |
| КРЭФУРД (CRAFOORD) Зажимы артериальные | 09 - 11 | ЛАХИ (LANEY) Зеркала хирургические | 13 - 20 |
| КРЭФУРД (CRAFOORD) Ножницы для лобэктомии | 03 - 24 | Лезвие ножа | 01 - 9 |
| КРЭФУРД-СЕЛЛОРС (CRAFOORD-SELLORS) Зажимы бронхиальные | 09 - 22 | Лезвие скальпеля | 01 - 5 |
| Крючки | | ЛЕКСЕР (LEXER) Ножницы | 03 - 32 |
| держатели брюшные | 15 - 24 | ЛЕКСЕР (LEXER) Ножницы анатомические | 03 - 11 |
| для вен | 13 - 8 | ЛЕКСЕР-БЭЙБИ (LEXER-BABY) Ножницы анатомические | 03 - 11 |
| для нервные | 13 - 4 | ЛЕРИХ (LERICHE) Зажимы артериальные | 09 - 9 |
| для предстательной железы | 19 - 8 | ЛЕРМОЙЕЦ (LERMOYEZ) Троякары | 17 - 7 |
| для слезных мешочков | 13 - 3 | Лигатор геморроидальный | 21 - 16 |
| для фистулы | 21 - 17; 23-25 | Лигатурные иглы | 11 - 23-27 |
| мозговые и кожные | 13 - 1 | ЛИГЬЮ (LEGUEU) Зеркала для мочевого пузыря | 19 - 6 |
| ранорасширители | 14 - 1-27 | ЛИГЬЮ (LEGUEU) Шпатель для мочевого пузыря | 19 - 8 |
| трахеальные | 13 - 3; 4 | ЛИМПЕРТ (LEMPERT) Кюретки костные | 27 - 2 |
| КУИНКЕ (QUINKE) Иглы пункционные поясничные | 17 - 15 | ЛИНКОЛЬН (LINCOLN) Ножницы сосудистые | 03 - 20 |
| КУЛИ (COOLEY) Отсасывающие трубки | 17 - 9;10 | ЛИТТАУЭР (LITTAUER) Ножницы для лигатуры | 03 - 19 |
| КУПЕР (COOPER) Иглы лигатурные | 11 - 24 | ЛИТТЛ (LITTLE) Зеркала хирургические | 13 - 21 |
| КУСКО (CUSCO) Зеркала вагинальные | 23 - 1; 2 | ЛИТТЛ-ВУД (LITTLE-WOOD) Зажимы захватывающие кишечные и хирургические | 21 - 2 |
| КУСКО (CUSCO) Зеркала вагинальные (ШВЕЙЦ. МОДЕЛЬ) | 23 - 2 | Лихтвитц (LICHTWITZ) Троякары | 17 - 8 |
| КУШИНГ (CUSHING) | | ЛИХТЕНБЕРГ (LICHTENBERG) Иглодержатели | 11 - 6, 19 |
| Крючки для вен | 13 - 8 | ЛИШТЕР (LISTER) Ножницы для повязок | 03 - 29, 40 |
| Крючки нервные | 13 - 4 | ЛИШТЕР (LISTER) Зажимы носовые | 07 - 3 |
| Пинцеты | 05 - 20 | ЛИШТОН (LISTON) Ножи ампутационные | 01 - 8 |
| Пинцеты анатомические | 05 - 4 | ЛЛОЙД-ДЭВИС (LLOYD-DAVIES) Ножницы для лобэктомии | 03 - 26 |
| Пинцеты хирургические | 05 - 11 | ЛОВЕЛАС (LOVELACE) Бронхиальные зажимы | 09 - 24 |
| КУШИНГ-ТЭЙЛОР (CUSHING-TAYLOR) Пинцеты | 05 - 20 | Ложки абортные | 23 - 38 |
| КЭННИ РИАЛ (CANNY RYA) Крючки | 13 - 12 | Ложки волчаночные | 25 - 1; 2 |
| Кюретки абортные | 23 - 37 | Ложки для удаления жёлчных конкрементов | 19 - 3; 4 |
| Кюретки биопсийные | 23 - 24 | Ложки маточные | 23 - 32 |
| Кюретки биопсийные, отсасывающие | 23 - 24 | ЛОКВУД (LOCKWOOD) Зажимы захватывающие кишечные и хирургические | 21 - 3 |
| Кюретки маточные | 23 - 27; 29; 32 | ЛОКХАРТ-МУММЕРИ (LOCKHART-MUMMERY) Зонды | 17 - 2 |
| Л | | Лонг (LONG) Щипцы гистерэктомические | 09 - 28 |
| ЛАНГЕ (LANGE) Зажимы шовные | 11 - 32 | ЛОРЕНЦ (LORENZ) Ножницы для повязок | 03 - 30 |
| ЛАНГЕНБЕК (LANGENBECK) | | ЛОРНА (LORNA) Зажимы для операционного белья | 07 - 2 |
| Зеркала хирургические | 13 - 14 | ЛОУЕР (LOWER) Зажимы артериальные | 09 - 21 |
| Иглодержатели | 11 - 20 | ЛУЙЕР-КЁРТЕ (LUER-KOERTE) Ложки для удаления жёлчных конкрементов | 19 - 3 |
| Ножи ампутационные | 01 - 9 | ЛУЙЕР-ЛОК (LUER-LOCK) Иглы специальные | 17 - 12 |
| Ранорасширители | 13 - 15 | ЛЭЙН (LANE) | |
| Распаторы для снятия надкостницы | 27 - 6 | Зажимы для операционного белья | 07 - 2 |
| Элеваторы для снятия надкостницы | 27 - 4 | Зажимы желудочные | 21 - 10 |
| ЛАНГЕНБЕК-ГРИН (LANGENBECK-GREEN) Крючки | 13 - 4 | Щипцы захватывающие кишечные | 21 - 2 |
| ЛАНДОЛТ (LANDOLT) Ножницы | 03 - 14 | Пинцеты хирургические | 05 - 13; 14 |
| ЛАУРЕНС (LAWRENCE) Зажимы | 09 - 21 | | |
| ЛАУРЕНС (LAWRENCE) Иглодержатели | 11 - 3 | | |

| | | | |
|---|--------------|--|--------------------------|
| ЛЭМБОТТЕ (LAMBOTTE) Остеотомы | 27 - 11 | МАРТИН (MARTIN) Зонды маточные | 23 - 23 |
| ЛЭМБОТТЕ (LAMBOTTE) Распаторы | 27 - 5 | МАРТИНИ (MARTINI) Кюретки костные | 27 - 3 |
| ЛЭНДАУ (LANDAU) Зеркала вагинальные, штыковидные | 23 - 11 | Маточные выкусыватели биопсийные | 23 - 32-34 |
| ЛЭНДАУ (LANDAU) Троякары | 17 - 6 | Маточные депрессоры | 23 - 16; 22 |
| М | | Маточные дилататоры | 23 - 15-17 |
| М.Г.Х. (M.G.H.) Иглодержатели | 11 - 2 | Маточные зонды | 23 - 22; 23 |
| МАЙЛЛИН (MILLIN) | | Маточные кюретки | 23 - 27; 29; 32 |
| Зеркала для мочевого пузыря | 19 - 7 | Маточные ложки | 23 - 32 |
| Расширители шейки мочевого пузыря | 19 - 7 | Маточные ножницы | 03 - 5 |
| Щипцы для накладывания лигатур | 19 - 7 | Маточные перфораторы | 23 - 25 |
| Щипцы для предстательной железы | 19 - 7 | Маточные щипцы | 23 - 37 |
| Щипцы захватывающие типа "аллигатор" | 19 - 7 | Маточные щипцы захватывающие | 23 - 21; 22 |
| МАЙО (MAYO) | | МЕЙЕРДИНГ (MEYERDING) Крючки | 13 - 5; 24 |
| Зонды для желчного протока | 19 - 4 | МЕНГХИНИ (MENGHINI) Иглы пункционные для печени | 17 - 15 |
| Ложки для удаления желчных конкрементов | 19 - 3 | Металлические боксы | 23 - 15;16 |
| Ножницы | 03 -5; 2; 41 | Металлические катетеры | 19 - 9 |
| Ножницы маточные | 03 - 5 | МЕТЦЕНБАУМ (METZENBAUM) | 03 - 7; 8; 33; 34; 41 |
| Ножницы хирургические | 03 - 5 | МЕТЦЕНБАУМ (METZENBAUM) | 11 - 2 |
| Щипцы для стерилизации | 29 - 1 | Иглодержатели | |
| МАЙО-БЛЭЙК (MAYO-BLAKE) | 19 - 1 | МЕТЦЕНБАУМ (METZENBAUM DELICATE) | 03 - 9 |
| Зажимы для желчных камней | | Ножницы тонкие | |
| МАЙО-НОБЛЕ (MAYO-NOBLE) | 03 - 6 | МЕТЦЕНБАУМ-ЛАХИ (METZENBAUM- LAHEY) Ножницы | 03 - 10 |
| Ножницы хирургические | | МЕТЦЕНБАУМ-НЕЛЬСОН (METZENBAUM- NELSON) Ножницы | 03 - 7; 8; 41 |
| МАЙО-РОБСОН (MAYO-ROBSON) | 21 - 7 | МЕТЦЕНБАУМ-ФИНО (METZENBAUM- FINO) Ножницы | 03 - 10; 34-36; 41 |
| Зажимы кишечные, атравматические | | МИДЛДОРФ (MIDDELDORPF) Крючки | 13 - 18; 19 |
| МАЙО-РОБСОН (MAYO-ROBSON) | 21 - 7 | МИКЕР (MEEKER) Зажимы артериальные | 09 - 20 |
| Зажимы кишечные | | Микро-иглодержатели | 11 - 7-10; 20 |
| МАЙО-СТИЛЛЕ (MAYO-STILLE) | 03 - 32 | Микро-зажимы перевязочные и лигатурные | 09 - 15 |
| Ножницы | | Микро-МОСКИТО (Micro-MOSQUITO) | 09 - 8 |
| МАЙО-СТИЛЛЕ (MAYO-STILLE) | 03 - 6 | Зажимы артериальные | |
| Ножницы хирургические | | Микро-ножницы | 03 - 8; 45- 47; 51 |
| МАЙО-ХИГАР (MAYO-HEGAR) | 11 - 3; 12 | Микро-ножницы для адвентиции | 03 - 51 |
| Иглодержатели | | Микро-ножницы рассекающие | 03 - 46 |
| МАЙО-ХИГАР (MAYO-HEGAR DELICATE) | 11 - 3 | Микро-пинцеты | 05 - 15 |
| Иглодержатели тонкие | | Микро-пинцеты анатомические | 05 - 3 |
| МАЙО-ЭДАМС (MAYO-ADAMS) | 15 - 4 | Микро-пинцеты хирургические | 05 - 8 |
| Ранорасширители для аппендэктомии | | Микро-РИДЕР (Micro-RYDER) | 11 - 13 |
| МАК ГИВНИ (MC GIVNEY) Щипцы геморроидальные захватывающие | 21 - 17 | Иглодержатели | |
| МАК ГИВНИ (MC GIVNEY) Лигаторы геморроидальные с наконечниками | 21 - 16 | МИКСТЕР (MIXTER) | |
| МАК ДОНАЛД (MC DONALD) Элеваторы | 27 - 4 | Зажимы артериальные | 09 - 20 |
| МАК ИНДО (MC INDOE) Ножницы для хрящей | 03 - 24 | Зажимы для желчных камней | 19 - 1 |
| МАК ИНДО (MC INDOE) Пинцеты анатомические | 05 - 3; 20 | Ножницы хирургические и гинекологические | 03 - 11 |
| МАК ИНДО (MC INDOE) Пинцеты хирургические | 05 - 10 | МИКУЛИЧ (MIKULICZ) | |
| МАК КУИГ-МИКСТЕР (MC QUIGG-MIXTER) | 09 - 22 | Зажимы перитональные | 09 - 25 |
| Зажимы перевязочные и лигатурные | | Зажимы сигмовидные для анастомоза | 21 - 11 |
| МАРТЕЛЬ (MARTEL) Зажимы для ткани | 09 - 4 | Зеркала хирургические | 13 - 22 |
| МАРТИН (MARTIN) Пельвиметр (тазомер) | 23 - 38 | МИЛАН (MILAN) Кюретки биопсийные | 23 - 24 |

СОДЕРЖАНИЕ РУССКИЙ

| | | | |
|--|----------------|---|---------------------------------|
| МИЛЛИГАН (MILLIGAN) Ранорасширители | 15 - 6 | Наконечники | 17 - 4 |
| Мини-ЛАНГЕНБЕК (Mini-LANGENBECK) Крючки | 13 - 5 | Неврологические ножницы | 03 - 18 |
| Мини-РОУКС (Mini-ROUX) Крючки | 13 - 11 | НЕГУС (NEGUS) Зажимы для желчного протока | 09 - 14 |
| Мини-ТАУНСЕНД (Mini-TOWNSEND) Щипцы биопсийные цервикальные | 23 - 34 | НЕЛЬСОН (NELSON) Пинцеты захватывающие | 05 - 12 |
| МИРТЛ (MYRTLE) Зонды пластинчатые | 17 - 1 | НЕЛЬСОН (NELSON) Троякары | 17 - 7 |
| МИШЕЛЬ (MICHEL) | | НЕРВЕ (NERVE) Ножницы анатомические | 03 - 13 |
| Зажимы для наложения хирургических скобок | 11 - 31 | НИВЕРТ (NEIVERT) Иглодержатели | 11 - 1 |
| Зажимы шовные | 11 - 32 | НИЛАТОН (NELATON) Зонды | 17 - 1 |
| Инструменты шовные | 11 - 32 | НОВАК (NOVAK) Кюретки биопсийные отсасывающие | 23 - 24 |
| Скобы хирургические | 11 - 32 | Ножи | |
| МОДЕЛЬ ВИН (MOD. WIEN) Инструменты шовные | 11 - 31 | ампутиационные | 01 - 8-10 |
| МОЙНИХАН (MOYNIHAN) Зонды и долота для удаления жёлчных конкрементов | 19 - 3 | для миомы | 23 - 25 |
| МОЙНИХАН (MOYNIHAN) Щипцы гистерэктомические | 09 - 27 | для органов | 01 - 9 |
| МОК (МОСК) Канюли ирригационные | 17 - 12 | для трансплантации кожи, дерматомы | 01 - 11 |
| МОЛЛИСОН (MOLLISON) Ранорасширители | 15 - 3 | мозговые | 01 - 9 |
| Молотки | 27 - 8; 11 | резекционные для хряща | 01 - 10 |
| МОРГАН (MORGAN) Проктоскопы | 21 - 15 | Ножницы | |
| МОРРИС (MORRIS) Зеркала хирургические | 13 - 22 | анатомические | 03 - 6; 10-13; 36; 41-44 |
| МУР (MOORE) Ложка для желчного пузыря | 19 - 4 | анатомические, микро-брюшные | 03 - 46 |
| МУСОЙКС (MUSEUX) Щипцы маточные зубчатые | 23 - 20 | гинекологические | 03 - 25 |
| МЭГИЛЛ (MAGILL) Мандрин | 17 - 10 | гистерэктомические | 03 - 11; 24; 25; 37 |
| МЭГИЛЛ (MAGILL) Отсасывающие трубки | 17 - 10 | для гипсовых повязок | 03 - 36 |
| МЭЙНГОТ (MAINGOT) Щипцы гистерэктомические | 09 - 27 | для кровеносных сосудов | 03 - 29; 30 |
| МЭССОН (MASSON) Иглодержатели | 11 - 4,15 | для лигатуры | 03 - 20-24; 38; 39; 44 |
| МЭТЦИНАУЕР (MATZENAUER) Зеркала вагинальные | 23 - 12 | для лобэктомии | 03 - 18; 19 |
| МЭТЬЮ (MATHIEU) | | для надреза | 03 - 24; 27 |
| Зеркала вагинальные | 23 - 11 | для нервов | 03 - 17 |
| Зеркала ректальные | 21 - 12 | для повязок | 03 - 13 |
| Иглодержатели | 11 - 6; 18; 19 | для пуповины | 03 - 29; 30; 40 |
| Крючки двусторонние | 13 - 11 | для резания проволоки | 03 - 28 |
| Щипцы для удаления инородных тел | 19 - 7 | для тенотомии | 03 - 29; 40 |
| МЭТЬЮ-КОХЕР (MATHIEU-KOCHER) Иглодержатели | 11 - 7; 18 | для тенотомии | 03 - 14; 43; 45 |
| НАБАТОФФ (NABATOFF) | | для трансплантации кожи, дерматомы | 01 - 11 |
| Зонды для варикозных вен | 17 - 4 | для фистулы | 03 - 26 |
| Кабель гибкий, стальной | 17 - 4 | для хрящей | 03 - 21; 24 |
| Коробки металлические | 17 - 4 | для цефалотомии | 03 - 26 |
| Наконечники | 17 - 4 | для эндартерэктомии | 03 - 42 |
| Оливы | 17 - 4 | для эпизиотомии | 03 - 27; 28 |
| Рукоятки | 17 - 4 | каронарные | 03 - 24 |
| Н | | кишечные анатомические | 03 - 26; 28 |
| Набор инструментов для варикозных вен | 17 - 4 | маточные | 03 - 5 |
| НАГЕР (NAGER) Иглы лигатурные | 11 - 27 | микро- | 03 - 8; 45; 47 |
| Назальные ножницы | 03 - 20; 21 | назальные | 03 - 19; 20; 21; 44 |
| Назальные щипцы | 09 - 11 | нейрохирургические | 03 - 18 |
| | | рассекающие | 03 - 6; 10-13; 17; 34-36; 41-44 |

| | |
|--|------------------------------------|
| Ножницы | |
| рассекающие, микро- | 03 - 46 |
| резекционные для хряща | 01 - 10 |
| хирургические | 03 - 1-6; 11; 16; 17; 31 |
| хирургические тонкие | 03 - 14; 15; 40; 42 |
| НОРТБЕНТ (NORTHBENT) Ножницы для лигатуры | 03 - 18 |
| НОРФОЛК-НОРВИЧ (NORFOLK-NORWICH) Ранорасширители | 15 - 10 |
| НОТО (NOTO) Щипцы для удаления полипов | 23 - 21 |
| НОУЛЕС (KNOWLES) Ножницы для пальцев | 03 - 30 |
| О | |
| ОВЕРХОЛТ-ГЕЙССЕНДОРФЕР (OVERHOLT-GEISSENDOERFER) Зажимы артериальные | 09 - 17 |
| ОВЕРХОЛТ-МИКСТЕР (OVERHOLT-MIXTER) Зажимы | 09 - 15 |
| Одноразовые скальпели стерильные | 01 - 3; 4 |
| О'КОННОР (O'CONNOR) Крючки тонкие | 13 - 1 |
| Оливы | 17 - 4; 9 |
| ОЛСЕН-ХИГАР (OLSEN-HEGAR) Иглодержатели / Ножницы | 11 - 5, 16 |
| Операционные ножи | 01 - 6 |
| Остеотомы | 27 - 7; 8; 10; 11 |
| О'СУЛЛИВАН-О'КОННОР (O'SULLIVAN-O'CONNOR) Рамка | 15 - 20 |
| О'СУЛЛИВАН-О'КОННОР (O'SULLIVAN-O'CONNOR) Ранорасширители брюшные | 15 - 20 |
| Отсасывающие кюретки | 23 - 24 |
| Отсасывающие трубки | 17 - 8-11 |
| ОХСНЕР (OCHSNER) Зонды для желчного протока | 19 - 4 |
| ОХСНЕР (OCHSNER) Троякары оторинологические | 17 - 7 |
| ОХСНЕР-КОХЕР (OCHSNER-KOCHER) Зажимы артериальные | 09 - 13 |
| П | |
| ПАЙФФЭРД (PIFFARD) Ложки волчаночные | 25 - 1 |
| Параллель (PAPARELL) ножницы | 03 - 16 |
| ПАРКЕР (PARKER) Крючки-ранорасширители | 13 - 11 |
| ПАРКЕР-ЛАНГЕНБЕК (PARKER-LANGENBECK) Крючки-ранорасширители | 13 - 12 |
| ПЕДИРСОН (PEDERSON) Зеркала вагинальные | 23 - 3 |
| ПЕЛКМАНН (PELKMAN) Зажимы анатомические | 07 - 4 |
| Пельвиметр (тазомер) | 23 - 38 |
| ПЕННИНГТОН (PENNINGTON) Зажимы | 09 - 4 |
| Перфоратор | 23 - 25 |
| ПЕСТАЛОЗЗА (PESTALOZZA) Кюретки абортные | 23 - 37 |

| | |
|---|-----------------------------|
| Пилы для пальцев, круглые | 25 - 3 |
| ПИН (PEAN) Зажимы артериальные | 09 - 6 |
| ПИН (PEAN DELICATE) Зажимы артериальные тонкие | 09 - 12 |
| Пинцеты | 05 - 1-20 |
| анатомические | 05 - 1-5; 18-20 |
| атравматические | 05 - 18 |
| для кровеносных сосудов | 05 - 18 |
| для наложения хирургических скобок | 11 - 31; 32 |
| для костных осколков | 05 - 14; 15 |
| для стерилизации | 29 - 1 |
| кишечные, захватывающие | 05 - 12 |
| микро- | 05 - 15 |
| хирургические | 05 - 1-14; 19; 20 |
| ювелирные | 05 - 17 |
| Пипер (PIPER) Щипцы акушерские | 23 - 36 |
| ПИРС (PEERS) Зажимы для операционного белья | 07 - 3 |
| ПИРСЕ (PIERCE) Троякары антральные | 17 - 7 |
| ПИ-СМИТ (ХЭРРИСОН) (PYE-SMITH (HARRISON)) Щипцы для стерилизации | 29 - 1 |
| ПЛЕСТЕР (PLESTER) Ранорасширители самоудерживающиеся | 15 - 6 |
| Подносы и лотки | 29 - 2 |
| ПОЗЗИ (POZZI) Щипцы маточные зубчатые | 23 - 18 |
| ПОППЕН (ФЕРГЮССОН) (POPPE (FERGUSSON)) Отсасывающие трубки | 17 - 11 |
| ПОТТС-ДЕ МАРТЕЛ (POTTS-DE MARTEL) Ножницы для кровеносных сосудов | 03 - 38 |
| ПОТТС-СМИТ (POTTS-SMITH) | |
| Ножницы | 03 - 27 |
| Ножницы для кровеносных сосудов | 03 - 23; 39 |
| Пинцеты анатомические | 05 - 4; 20; |
| Пинцеты хирургические | 05 - 11 |
| ПРАТТ (PRATT) | |
| Крючки для фистулы | 21 - 17 |
| Расширители канала шейки матки | 23 - 17 |
| Щипцы геморроидальные | 09 - 5 |
| Щипцы маточные | 23 - 20 |
| ПРЕСБИТЕРИАН (PRESBYTERIAN) Зажимы для трубок | 07 - 6 |
| ПРИНЦ (PRINCE) Ножницы назальные | 03 - 21 |
| ПРИНЦ (PRINCE) Зажим бронхиальный | 09 - 25 |
| Пробойники дерматологические | 25 - 1 |
| ПРОВИДЕНС-ГОСПИТАЛ (PROVIDENCE-HOSPITAL) Зажимы артериальные | 09 - 7 |
| Проктоскопы | 21 - 14; 15 |
| Пружинная закручиваемая головка | 17 - 16 |
| ПУЛ (POOLE) Отсасывающие трубки | 17 - 8 |
| ПЭЙР (PAYR) | |
| Желудочные зажимы для разрушения | 21 - 9 |
| Зонды лигатурные | 11 - 29 |
| Кишечные зажимы для разрушения | 21 - 9 |

СОДЕРЖАНИЕ РУССКИЙ

| | | | |
|--|-----------------|---|-------------|
| ПЭЙР-БЭЙБИ (PAYR-BABY) Кишечные зажимы для разрушения | 21 - 9 | РОИДЕР (ROEDER) Зажимы для операционного белья | 07 - 1 |
| ПЭРТШ (PARTSCH) Долото костное | 27 - 7; 8 | РОУКС (ROUX) Крючки | 13 - 10 |
| ПЭРТШ (PARTSCH) Молотки | 27 - 8; 11 | РОХАРД (ROCHARD) | |
| Р | | Рамки манипуляционные | 15 - 24 |
| РАГНЕЛЛ (RAGNELL) Крючки | 13 - 6 | Ранорасширители брюшные | 15 - 24 |
| РАГНЕЛЛ-ДЭВИС (RAGNELL-DAVIS) Крючки | 13 - 6 | Устройства фиксирующие, для ранорасширителей брюшных | 15 - 24 |
| Рамки | 15 - 23 | РОЧЕСТЕР-КАРМАЛТ (ROCHESTER-CARMALT) Зажимы изогнутые | 09 - 12 |
| Рамки для расширителя брюшины | 15 - 20; 23 | РОЧЕСТЕР-ПИН (ROCHESTER-PEAN) Зажимы артериальные | 09 - 13 |
| Рамки для держателя брюшины | 15 - 23 | РУДД (RUDD) Лигаторы геморроидальные | 21 - 16 |
| Рамки манипуляционные | 15 - 24 | РУМЕЛЬ (RUMEL) Зажимы перевязочные | 09 - 16 |
| РАМПЛЕЙ (RAMPLEY) Корнцанги | 07 - 5 | РУССКАЯ МОДЕЛЬ (RUSS. MOD.) Пинцеты хирургические | 05 - 11 |
| Ранорасширители | 15 - 1-13; 27 | Ручка скальпеля | 01 - 1; 2 |
| Ранорасширители для аппендэктомии | 15 - 4 | РЭДОЛФ (RADOLF) Щипцы для ногтей | 25 - 3 |
| Ранорасширители для бедренных суставов | 13 - 14 | РЭНДАЛЛ (RANDALL) Зажимы для почечных камней | 19 - 1 |
| Ранорасширители скальпа | 15 - 2 | РЭНДАЛЛ (RANDALL) Кюретки биопсийные, отсасывающие | 23 - 24 |
| Распаторы | 27 - 4-6 | С | |
| Расширители | | СААЛФИЛД (SAALFELD) Экстракторы угрей | 25 - 2 |
| вагинальный | 15 - 10 | САНВЕНЕРО (SANVENERO) Ножницы хирургические | 03 - 13 |
| для брюшины | 15 - 14-23 | САРОТ (SAROT) Иглодержатели | 11 - 11; 15 |
| для желчного протока | 19 - 5 | САРОТ (SAROT) Зажимы артериальные | 09 - 14 |
| для кровеносных сосудов | 05 - 17 | САТИНСКИ (SATINSKY) Ножницы для сосудов | 03 - 24 |
| для мочевого пузыря | 19 - 6 | САУЕРБРУХ (SAUERBRUCH) Зеркала хирургические | 13 - 17 |
| для сосудов | 05 - 17 | Св. МАРКС (ST. MARKS) Зеркала хирургические | 13 - 27 |
| канала шейки матки | 23 - 16; 17 | СЁКИЛЭНД (SÖKELAND) Зажимы для желчных камней | 19 - 2 |
| ран | 15 - 1-13; 27 | СЕМБ (SEMB) Зажимы бронхиальные | 09 - 25 |
| рёберные | 15 - 26; 27 | СЕНН-ГРИН (SENN-GREEN) Крючки | 13 - 5 |
| ректальные | 21 - 12 | СЕНН-МИЛЛЕР (SENN-MILLER) Крючки | 13 - 6 |
| РЕВЕРДИН (REVERDIN) Иглы | 11 - 22 | СИБОЛД (SIEBOLD) Ножницы гинекологические | 03 - 25 |
| РЕВЕРДИН (REVERDIN) Шпатели брюшные | 15 - 25 | СИГОНД (SEGOND) Ножи для миомы | 23 - 25 |
| РЕЙНОЛДС (REYNOLDS) Ножницы анатомические | 03 - 12; 36; 43 | СИДАЙЛЛОТ (SEDILLOT) Распаторы | 27 - 6 |
| Ректальные ножницы | 03 - 27 | СИЛВЕР (SILVER) Запасные лезвия | 01 - 11 |
| Ректальные ретрактор | 21 - 13 | СИЛВЕР (SILVER) Ножи для трансплантации кожи, дерматомы | 01 - 11 |
| Ректальные щипцы биопсийные | 21 - 16 | СИМ (SYME) Иглы лигатурные | 11 - 24 |
| Ретрактор для вагинального зеркала | 23 - 5; 12; 21 | СИМКЕН (SEMKEN) Пинцеты хирургические | 05 - 10 |
| РИГЛИ (WRIGLEY) Щипцы акушерские | 23 - 35 | СИМКЕН (SEMKEN) Пинцеты анатомические | 05 - 4 |
| РИДЕР-ФРЕНЧ-АЙ (RYDER-FRENCH-EYE) Иглодержатели | 11 - 14 | СИММ (SEMM) | 15 - 23 |
| РИКАМИЕР (RECAMIER) Кюретки маточные | 23 - 26; 28 | Зеркала вагинальные | 23 - 3 |
| РИКАРД (RICARD) Ранорасширители брюшные | 15 - 14 | Рамка для расширителя брюшины | 15 - 23 |
| РИХТЕР (RICHTER) Ранорасширители | 15 - 10 | Сменные лопатки для расширителя брюшины | 15 - 23 |
| РИХТЕР-ХЕТ (RICHTER-HEATH) Зажимы для наложения хирургических скобок | 11 - 31 | | |
| РИЧАРДСОН (RICHARDSON) Зеркала хирургические | 13 - 18 | | |
| РИЧАРДСОН-ИСТМАН (RICHARDSON-EASTMAN) Крючки | 13 - 19 | | |
| РОБЕРТС (ROBERTS) Зажимы артериальные | 09 - 14 | | |
| РОБИН-МАССЕ (ROBIN-MASSE) Ранорасширители брюшные | 15 - 15 | | |
| РОДЖ (ROGGE) Щипцы для стерилизации | 29 - 1 | | |

| | | | |
|--|------------------------------|--|--|
| СИМОН (SIMON) | | | |
| Зеркала хирургические | 13 - 21 | | |
| Крючки для фистулы | 23 - 25 | | |
| Ложечки маточные | 23 - 32 | | |
| Ранорасширитель | 13 - 21 | | |
| СИМПСОН (SIMPSON) Зонды маточные | 23 - 23 | | |
| СИМПСОН (SIMPSON) Щипцы акушерские | 23 - 35 | | |
| СИМПСОН-БРАУН (SIMPSON-BRAUN) Щипцы акушерские | 23 - 35 | | |
| СИМПСОН-ЛУИКАРТ (SIMPSON-LUIKART) Щипцы акушерские | 23 - 35 | | |
| СИМС (SIMS) | | | |
| Депрессоры маточные | 23 - 22 | | |
| Зеркала вагинальные | 23 - 10; 11 | | |
| Зеркала ректальные | 21 - 12 | | |
| Зонды маточные | 23 - 22 | | |
| Кюретки маточные | 23 - 27; 29 | | |
| Ножницы гинекологические | 03 - 24; 25; 37 | | |
| СИНГЛИ-ТУТТЛ (SINGLEY-TUTTLE) Пинцеты захватывающие | 05 - 5 | | |
| Скальпель | 01 - 3; 4; 6; 7 | | |
| Скальпель анатомический | 01 - 7 | | |
| Скальпель одноразовый | 01 - 3; 4 | | |
| СКИНЕ (SKENE) Щипцы маточные зубчатые | 23 - 19 | | |
| Скобы хирургические | 11 - 32 | | |
| СКУДДЕР (SCUDDER) Зажимы кишечные | 21 - 10 | | |
| Сменные лопатки | 15 - 6; 11-5; 18; 20; 21; 23 | | |
| СМИТ-БУИ (SMITH-BUIE) Зеркала анальные | 21 - 12 | | |
| СМИТ-ПИТЕРСЕН (SMITH-PETERSEN) Долота | 27 - 10 | | |
| СМИТ-ПИТЕРСЕН (SMITH-PETERSEN) Остеотомы | 27 - 10 | | |
| Соединительные детали | 17 - 16; 17 | | |
| СОМЕР (SOMER) Зажимы для матки | 23 - 21 | | |
| СПЕНСЕР-ВЕЛЛС (SPENCER-WELLS) Зажимы артериальные | 09 - 6 | | |
| СПЕНСЭР (SPENCER) Ножницы для лигатуры | 03 - 19 | | |
| Специальные канюли | 17 - 12 | | |
| СТАЙК (STACKE) Зонды ушные | 17 - 1 | | |
| СТАЙЛ (STILLE) | | | |
| Долота | 27 - 9 | | |
| Долота для костей | 27 - 8 | | |
| Зажимы для почечной ножки | 09 - 23 | | |
| Остеотомы | 27 - 8 | | |
| Пинцеты анатомические | 05 - 3 | | |
| Пинцеты хирургические | 05 - 9 | | |
| Стакан для пинцетов | 29 - 2 | | |
| Стандартные ножницы | 03 - 1; 2; 31 | | |
| Стандартные троакары | 17 - 5 | | |
| Стандартные пинцеты анатомические | 05 - 1 | | |
| Стандартные пинцеты хирургические | 05 - 7 | | |
| СТАУД-МУР (STAUDE-MOORE) Щипцы маточные зубчатые | 23 - 17 | | |
| СТЕЛЗНЕР (STELZNER) Ножницы для лобэктомии | 03 - 27 | | |
| СТИВЕНС (STEVENS) Микро-ножницы | 03 - 47 | | |
| СТИВЕНС (STEVENS) Ножницы для тенотомии | 03 - 14, 43 | | |
| СТОКМАНН (STOCKMANN) Зажимы для мочеиспускательного канала | 19 - 10 | | |
| СТРАБИСМУС (STRABISMUS) Ножницы | 03 - 14; 42 | | |
| СТРАТТ (STRATTE) Иглодержатели | 11 - 5; 17 | | |
| СТРАУСС (STRAUSS) Зажимы для мочеиспускательного канала | 19 - 10 | | |
| СТРУЛЛИ (STRULLY) Ножницы нейрохирургические | 03 - 18 | | |
| Сумка для хирургических инструментов | 23 - 16 | | |
| Сфинктероскопы | 21 - 14 | | |
| США (MOD. USA) Ножницы | 03 - 28 | | |
| США (MOD. USA) Пинцеты анатомические | 05 - 8 | | |
| СЭЛДИНГЕР-СТАЙЛ (SELDINGER-STILLE) Канюли биопсийные | 17 - 13 | | |
| Т | | | |
| ТЕРЬЕР (TERRIER) Зажимы артериальные | 09 - 5 | | |
| ТИЛЕ (TEALE) Щипцы маточные | 23 - 19 | | |
| ТИШЛЕР-КЕВОРКЯН (TISCHLER-KEVORKIAN) Щипцы биопсийные цервикальные | 23 - 34 | | |
| ТИШЛЕР-МОРГАН (TISCHLER-MORGAN) Щипцы биопсийные цервикальные | 23 - 34 | | |
| ТОЕННИС (TOENNIS) Зажимы артериальные | 09 - 18 | | |
| Иглодержатели | 11 - 5; 17 | | |
| Ножницы анатомические | 03 - 17 | | |
| ТОЕННИС-ЭДСОН (TOENNIS-ADSON) Ножницы | 03 - 35 | | |
| ТОЕННИС-ЭДСОН (TOENNIS-ADSON) Ножницы рассекающие | 03 - 10; 17; 42 | | |
| ТОМС-ГАЙЛОР (THOMS-GAYLOR) Щипцы биопсийные цервикальные | 23 - 32 | | |
| ТОМСОН-УОЛКЕР (THOMSON-WALKER) Зеркала для мочевого пузыря | 19 - 6 | | |
| ТОМС-ЭЛЛИС (THOMS-ALLIS) Зажимы кишечные и хирургические | 21 - 3 | | |
| Тонкие (Delicate) артериальные зажимы | 09 - 12 | | |
| Тонкие атоносители | 17 - 3 | | |
| Тонкие ножницы | 03 - 14-16; 40; 42; 44 | | |
| Тонкие ножницы рассекающие | 03 - 44 | | |
| Тонкие ножницы хирургические | 03 - 15; 16; 40; 42 | | |
| Тонкие пинцеты хирургические | 05 - 7 | | |
| Тонкие ранорасширители | 13 - 1; 2 | | |
| ТОРЕК (THOREK) Ножницы анатомические | 03 - 13 | | |
| ТОХОКУ-ДЖАПАН (ТОНОКУ-ЯПАН) Зажимы для операционного белья | 07 - 3 | | |
| ТРЕВЕС (TREVES) Пинцеты хирургические | 05 - 13 | | |
| ТРИЛАТ (TRELAT) Иглы лигатурные | 11 - 27 | | |
| Троакары | 17 - 5-8; 15 | | |

СОДЕРЖАНИЕ РУССКИЙ

| | |
|---|---------|
| Троакары антральные | 17 - 7 |
| ТУОХИ (TUOHY) Иглы | 17 - 15 |
| ТУРНЕР-ВАРВИК (TURNER-WARWICK) Зажимы для желчных камней | 19 - 2 |
| ТУРНЕР-ВАРВИК (TURNER-WARWICK) Ранорасширители брюшные | 15 - 19 |
| ТУФФИЕР (TUFFIER) | |
| Зажимы артериальные | 09 - 3 |
| Расширители рёберные | 15 - 26 |
| Шпатели брюшные | 15 - 25 |
| ТЭЙЛОР (TAYLOR) Пинцеты хирургические | 05 - 10 |
| ТЭЙЛОР (TAYLOR) Пинцеты анатомические | 05 - 3 |

У

| | |
|---|-------------|
| УКЕРМАН (UCKERMANN) Ватоносители | 17 - 3 |
| УЛРИХ (ULRICH) Зажимы для полипов | 07 - 4 |
| Универсальные ножницы для повязок | 03 - 30 |
| Универсальные ножницы для резания проволаки | 03 - 29; 40 |
| Универсальные Троакары | 17 - 5 |
| УННА (UNNA) Экстракторы угрей круглые | 25 - 2 |
| Уро-тангентиальные зажимы | 09 - 24 |
| Устройства фиксирующие, для ранорасширителей брюшных | 15 - 24 |
| Ушные зонды | 17 - 1 |

Ф

| | |
|---|------------|
| ФАВАЛОРО (FAVALORO) Ножницы артериальные | 03 - 23 |
| ФАЙНСЕН (FINSSEN) Ранорасширители | 15 - 1 |
| ФАЛК (FALK) Иглы лигатурные | 11 - 27 |
| ФАЛЛЕКС (VALLEIX) Зонды маточные | 23 - 23 |
| ФАРАБЕУФ (FARABEUF) Крючки двусторонние | 13 - 10 |
| ФАРАБЕУФ (FARABEUF) Распаторы для снятия надкостницы | 27 - 5 |
| ФАРРЕЛ (FARREL) Ватоносители | 17 - 3 |
| ФАУРЭ (FAURE) Зажимы перитональные брюшные | 09 - 26 |
| ФАУРЭ (FAURE) Щипцы биопсийные цервикальные шейные | 23 - 32 |
| ФЕРГЮССОН (FERGUSON) | |
| Ангиотрибы | 09 - 5 |
| Ложки для удаления желчных конкрементов | 19 - 3 |
| Ножницы хирургические | 03 - 17 |
| Отсасывающие трубки | 17 - 11 |
| ФЕРРИС-СМИТ (FERRIS-SMITH) Хирургические пинцеты | 05 - 5; 13 |
| ФИЛЬХИНФИЛД (FEILCHENFELD) Пинцеты костные | 05 - 15 |
| ФИНОЧЕТТО (FINOCCHIETTO) | |
| Зажимы артериальные | 09 - 22 |
| Иглодержатели | 11 - 4; 15 |
| Ножницы для лобэктомии | 03 - 27 |
| Расширители рёберные | 15 - 26 |

| | |
|--|-------------|
| ФИНОЧЕТТО-БЭЙБИ (FINOCCHIETTO- BABY) Расширители рёберные | 15 - 26 |
| ФИРХОВ (VIRCHOW) Ножки мозговые | 01 - 9 |
| ФОКС (FOX) Ложки волчаночные | 25 - 2 |
| ФОЛКМАНН (VOLKMANN) Крючки | 13 - 13 |
| ФОЛКМАНН (VOLKMANN) Кюретки костные | 27 - 1; 3 |
| ФОМОН (FOMON) Ножницы назальные | 03 - 19; 44 |
| ФОМОН (FOMON) Ножницы рассекающие | 03 - 6 |
| ФОРСТЕР (FOERSTER) Корнцанги | 07 - 5 |
| ФОРСТЕР-БЭЛЛИНГЕР (FOERSTER- BALLENGER) Корнцанги | 07 - 5 |
| ФРАЙЗЕР (FRAZIER) Крючки мозговые и кожные | 13 - 1 |
| ФРАЙЗЕР (FRAZIER) Отсасывающие трубки | 17 - 11 |
| ФРАНЗ (FRANZ) | |
| Держатели брюшные | 15 - 23 |
| Рамка для расширителя брюшины | 15 - 23 |
| Сменные лопатки для брюшины | 15 - 23 |
| ФРИТШ (FRITSCH) Крючки- ранорасширители | 13 - 19 |
| ФЭНЬЮФ (PHANEUF) Щипцы изогнутые | 09 - 26 |

Х

| | |
|--|-------------------|
| ХАБЕРЕР (HABERER) Шпатели брюшные | 15 - 25 |
| ХАЙЕС (HAYES) Зажимы сигмовидные для анастомоза | 21 - 11 |
| ХАЙПТ (HAIGHT) Расширители рёберные | 15 - 27 |
| ХАЛЛЭ (HALLE) Ножницы назальные | 03 - 19 |
| ХАМБИ (HUMBY) Ножки для трансплантации кожи, дерматомы | 01 - 11 |
| ХАНИ (HEANEY) Иглодержатели | 11 - 4 |
| ХАНТЕР (HUNTER) Пинцеты костные | 05 - 15 |
| ХАРРИНГТОН (HARRINGTON) Зеркала хирургические | 13 - 23 |
| ХАРТМАНН (HARTMANN) Зажимы артериальные | 09 - 6 |
| ХЕГЕМАНН-ДИТРИХ (HEGEMANN- DIETRICH) Ножницы для кровеносных сосудов | 3 - 22; 38; 39 |
| ХЕГЕНБАРТ (HEGENBARTH) Зажимы шовные | 11 - 31 |
| ХЕЙВУД-СМИТ (HEYWOOD-SMITH) Щипцы геморроидальные | 23 - 21 |
| ХЕЙМАНН (HEYMANN) Ножницы назальные | 03 - 20 |
| ХЕЙС (HEISS) Зажимы артериальные | 09 - 14 |
| ХЕПП-ШЕЙДЕЛ (HEPP-SCHIEDL) | |
| Микро-иглодержатели | 11 - 20 |
| Микро-ножницы | 3 - 45 |
| Отсасывающие трубки с ирригацией | 17 - 10 |
| ХЕРРИК (HERRICK) Зажимы для почечной ножки | 09 - 24 |
| ХЕСС (HESS) Зажимы "бульдог" | 09 - 1 |
| ХЕССБЕРГ (HESSBERG) Иглы лигатурные | 11 - 26 |

| | |
|---|---------------------------------|
| ХИГАР (HEGAR) Расширители канала шейки матки | 23 - 15;16 |
| ХИГАР-БАУМГАРТНЕР (HEGAR-BAUMGARTNER) Иглодержатели | 11 - 1; 10 |
| ХИНИ (HEANEY) Щипцы гистерэктомические | 09 - 29 |
| ХИНИ-БАЛЛАНТИН (HEANEY-BALLANTINE) Щипцы гистерэктомические | 09 - 28 |
| ХИНИ-КАНТЕР (HEANEY-KANTER) Щипцы гистерэктомические | 09 - 28 |
| Хирургические ножницы | 03 - 1-6; 11; 15-17; 31; 40; 42 |
| Хирургические пинцеты | 05 - 5-14; 20 |
| ХИРШМАНН (HIRSCHMANN) Анускопы | 21 - 14 |
| ХОЗЕМАНН (HOSEMANN) Зажимы артериальные | 09 - 21 |
| ХУРВИЦ (HURWITZ) Троякары | 17 - 5 |
| ХУРД (HURD) Иглы лигатурные | 11 - 27 |
| ХЭЛЛ (HALLE) Кюретки костные | 27 - 2 |
| ХЭЛСИ (HALSEY) Иглодержатели | 11 - 1 |
| ХЭЛСТЕД (HALSTED) Зажимы артериальные | 09 - 7 |
| ХЭЛСТЕД-МОСКИТО (HALSTED-MOSQUITO) Зажимы артериальные | 09 - 7 |
| ХЭНК (HANK) Расширители канала шейки матки | 23 - 16 |
| ХЭНЛИ (HENLEY) Ранорасширители | 15 - 11 |
| ХЭНЛИ (HENLEY) Сменные лопатки | 15 - 11 |

Ц

| | |
|---------------------------------|---------|
| ЦВЕЙФИЛ (ZWEIFEL) Иглодержатели | 11 - 20 |
| Цель с весами медицинская | 15 - 24 |

Ч

| | |
|---------------------------------------|---------|
| ЧАЙЛД (CHILDE) Зажимы шовные | 11 - 32 |
| ЧАПУТ (CHAPUT) Зажимы артериальные | 09 - 3 |
| ЧЕЛСИ ИТОН (CHELSEA EATON) Анускопы | 21 - 15 |
| ЧЕРНИ (CZERNY) | |
| Зажимы для желчных камней | 19 - 2 |
| Ранорасширители-крючки | 13 - 12 |
| Щипцы маточные зубчатые | 23 - 20 |
| ЧЕРОН (CHERON) Зажимы для тампонов | 07 - 4 |
| ЧЕТЛ (CHEATLE) Щипцы для стерилизации | 29 - 1 |

Ш

| | |
|---|---------|
| ШАМБЕРГ (SCHAMBERG) Экстракторы угрей | 25 - 2 |
| ШВЕЦАРСКАЯ МОДЕЛЬ (SWISS PATTERN) Вагинальное зеркало | 23 - 2 |
| ШВЕЦАРСКАЯ МОДЕЛЬ (SWISS PATTERN) Иглодержатель | 11 - 14 |
| ШЕДЕ (SCHEDE) Кюретки костные | 27 - 1 |
| ШЕРБАК (SCHERBAK) Зеркала вагинальные | 23 - 4 |
| ШИНК (SCHINK) Ножи для трансплантации кожи, дерматомы | 01 - 11 |
| ШИНК (SCHINK) Пластины для натяжения кожи | 01 - 10 |

| | |
|--|---------|
| ШМИД (SCHMID) Иглы | 17 - 14 |
| ШМИДЕН (SCHMIEDEN) Зонды лигатурные | 11 - 29 |
| ШМИДЕН (SCHMIEDEN) Иглы лигатурные | 11 - 25 |
| ШМИДЕН-ПАЙР (SCHMIEDEN-PAYR) Зонды лигатурные | 11 - 29 |
| ШМИДЕН-ТЭЙЛОП (SCHMIEDEN-TAYLOR) Ножницы мозговые | 03 - 20 |
| ШМИД-САВТЕЛЛ (SCHMIDEN-CABTELL) Ножницы назальные | 09 - 11 |
| ШОРТБЕНТ (SHORTBENT) Ножницы для лигатуры | 03 - 18 |
| Шпатели для брюшины | 15 - 25 |
| Шпатели для легких | 13 - 27 |
| Шпатели для мочевого пузыря | 19 - 8 |
| ШРЁДЕР (SCHROEDER) Щипцы маточные | 23 - 18 |
| ШУБЕРТ (SCHUBERT) Щипцы биопсийные цервикальные | 23 - 33 |
| ШУКХНЕХТ (SCHUNKNECHT) Ранорасширители | 15 - 3 |
| ШУМАХЕР (SCHUMACHER) Ножницы для пуповины | 03 - 28 |
| ШУМАХЕР (SCHUMACHER) Щипцы биопсийные цервикальные | 23 - 33 |
| ШУМАХЕР-ВАН ДОРЕН (SCHUMACHER-VAN DOREN) Щипцы биопсийные цервикальные | 23 - 32 |

Щ

| | |
|-------------------------------------|--------------------|
| Щипцы | |
| акушерские | 23 - 35; 36 |
| геморроидные | 21 - 17 23 - 21 |
| гистерэктомические | 09 - 26-29 |
| для накладывания лигатур | 19 - 7 |
| для ногтей | 25 - 3 |
| для плаценты и абортос (абортцанги) | 23 - 21; 37; 38 |
| для предстательной железы | 19 - 7 |
| для стерилизации | 29 - 1 |
| для удаления инородных тел | 19 - 7 |
| для удаления полипов | 23 - 21 |
| захватывающие | 19 - 7 |
| кусачки для ногтей | 25 - 3 |
| маточные | 23 - 37 |
| маточные зубчатые | 23 - 17-20 |
| ректальные биопсийные | 21 - 16 |

Э

| | |
|---------------------|---------------|
| ЭДСОН (ADSON) | |
| Долота для костей | 27 - 5 |
| Зажимы артериальные | 09 - 11 |
| Иглодержатели | 11 - 2 |
| Отсасывающие трубки | 17 - 9 |
| Пинцеты | 05 - 3; 8; 20 |
| Ранорасширители | 15 - 2 |
| Распаторы | 27 - 5 |
| Элеваторы | 27 - 5 |

СОДЕРЖАНИЕ РУССКИЙ

| | | | |
|---|-----------|--|---------|
| ЭДСОН (КОН) (ADSON (CONE)) Ранорасширители | 15 - 7 | ЭЛЛИСОН (ALLISON) Шпатели для лёгких | 13 - 27 |
| ЭДСОН-БРАУН (ADSON-BROWN) Пинцеты | 05 - 9 | ЭЛЛИС-ЭДЭЙР (ALLIS-ADAIR) Кишечные зажимы для захватывания тканей | 21 - 2 |
| ЭДСОН-БЭЙБИ (ADSON-BABY) Ранорасширители | 15 - 2 | ЭНДРЮ-ПИНХОН (ANDREW-PINCHON) Отсасывающие трубки | 17 - 9 |
| ЭДЭЙР (ADAIR) Щипцы маточные | 23 - 17 | ЭНТОНИ (ANTHONY) Отсасывающие трубки | 17 - 9 |
| ЭЙРЕ (AYRE) Нож для миомы | 23 - 25 | ЭППЕНДОРФ (EPPENDORF) Щипцы биопсийные цервикальные | 23 - 33 |
| ЭЙСЕЛСБЕРГ (EISELSBERG) Ножницы для лигатуры | 03 - 18 | ЭСМАРХ (ESMARCH) Ножницы для повязок | 03 - 30 |
| Экстракторы угрей | 25 - 2 | | |
| ЭЛАН ПАРКС (ALAN PARKS) Зеркала анальные | 21 - 13 | Я | |
| Элеватор | 27 - 4 | ЯКОБИ (JACOBI) Иглы лигатурные | 11 - 26 |
| ЭЛЛЕН (ALLEN) Зажимы кишечные | 21 - 1 | ЯКОБС (JACOBS) Щипцы маточные зубчатые | 23 - 19 |
| ЭЛЛИОТ (ELLIOT) Щипцы акушерские | 23 - 36 | ЯНКАУЭР (YANKAUER) Отсасывающие трубки | 17 - 9 |
| ЭЛЛИС (ALLIS) Кишечные зажимы для захватывания тканей, атравматические | 21 - 1; 3 | ЯРХО (JARCHO) Щипцы маточные зубчатые | 23 - 18 |
| ЭЛЛИС (ALLIS) Кишечные зажимы для захватывания тканей | 21 - 1; 3 | | |
| ЭЛЛИС-БЭЙБИ (ALLIS-BABY) Кишечные зажимы для захватывания тканей | 21 - 1 | | |